

€

P



Tabela de preços



2019

[www.beta-tools.com](http://www.beta-tools.com)

**bolas**  
máquinas e ferramentas

Representante Exclusivo para Portugal:

**Bolas - Máquinas e Ferramentas de Qualidade, S.A.****SEDE E ARMAZÉM CENTRAL:**

Zona Industrial Almeirim Norte  
Rua Sebastião Mendes Bolas, nº 7  
7006-801 ÉVORA  
Ap.53 EC Rossio | 7006-801 ÉVORA | Portugal  
Telf. 266 749 300 (6 linhas) | Fax 266 749 309  
E-mail: geral@bolas.pt

**DELEGAÇÃO LISBOA:**

ALVERCA PARK-NÚCLEO EMPRESARIAL  
Estrada Nacional 10, km 126,5  
2615-660 SOBRALINHO  
Ap.78 EC Alverca  
2616-907 ALVERCA DO RIBATEJO | Portugal  
Telf. 219 588 750 (3 linhas) | Fax 219 588 759  
E-mail: del.lisboa@bolas.pt

**DELEGAÇÃO NORTE:**

CENTRO DE NEGÓCIOS DO FREIXEIRO  
Rua Antero de Quental, 280  
4455-586 PERAFITA  
Ap.5142 EC Freixeiro  
4456-901 PERAFITA | Portugal  
Telf. 229 997 070/1 | Fax 229 965 169  
E-mail: del.norte@bolas.pt

[www.bolas.pt](http://www.bolas.pt)

# A HISTÓRIA DAS FERRAMENTAS ITALIANAS

**1923** - Alessandro Ciceri fundou a “Alessandro Ciceri & Figli”, dedicada à produção de moldes em ferro e aço.

**1939** - Foi registada a marca Beta, focalizada sobretudo na produção de ferramentas para profissionais.

**1960** - A Beta Utensili contava com 200 colaboradores, dava início à exportação dos seus produtos e destacava-se como fabricante em ascensão de ferramentas para profissionais.

**1969** - Foi desenvolvido o revolucionário trolley “Tank” em chapa metálica cor de laranja; a partir desse momento a cor laranja tornou-se a imagem de marca da Beta.

**1971** - A Beta Utensili entra no mundo do desporto automóvel, com o objectivo de testar e desenvolver os seus produtos.

**1975** - A Empresa consegue a sua primeira vitória na Formula 1 com o March laranja da Beta Utensili pilotado por Vittorio Brambilla, que ganhou o Grande Prémio da Áustria em Zeltweg, sob chuva intensa.

**1980** - A Beta Utensili intensificou a sua presença nos principais mercados europeus, criando progressivamente filiais em França, Inglaterra, Holanda, Espanha, Polónia e Hungria.

**1995** - Em apenas 8 meses a Empresa conseguiu obter a certificação do seu Sistema de Qualidade conforme os padrões na norma ISO 9001.

**2000** - O lançamento do novo catálogo Beta Utensili confirmou o crescimento em curso. A gama de artigos disponíveis duplicou, e as mais de 10,000 referências foram divididas em 20 famílias de produtos.

**2002** - A gama Beta Utensili foi ampliada e complementada com calçado de segurança e vestuário de trabalho e lazer, a gama “Beta Work”.

**2009** - A Beta continuou a expandir os seus mercados e inaugura a Beta China.

**2012** - Foi fundada a Beta Brasil.

**2016** - A Beta apresenta a nova oficina modular.

**2018** - **BM** Em 2018 a BM S.p.A - líder na produção e venda de terminais de cravar e sistemas elétricos - integrou o Grupo Beta.

**2019** - O contínuo crescimento da marca traduz-se na actual gama de produtos – distribuída por todo o mundo – que ultrapassa as 12,000 referências, concebidas para satisfazer as necessidades dos profissionais mais exigentes.



1939 Departamento de forja



1950 Departamento de galvanização



1955 Departamento de cisalhamento



1960 Armazém



1969 Trolley “Tank”



1975 Acabamento cromado



1974 Vittorio Brambilla

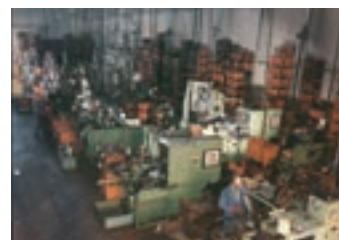

1980 Departamento de engenharia



1981 Novos jogos de ferramentas



2002 “BetaWork”



2016 Mobiliário para Oficina RSC55



2018 Fabio Quartararo

**BETA UTENSILI S.p.A.** - 20845 Sovico (MB)

Via A.Volta, 18 - Tel. 039.2077.1 - Telefax 039.2010742

[www.beta-tools.com](http://www.beta-tools.com)

**Robur Wire acessórios para cabos:** 67039 Sulmona (AQ)

Zona industriale - C.da S. Nicola - Tel. 0864.2504.1 - Telefax 0864.253132

[www.roburitaly.com](http://www.roburitaly.com) - [info@roburitaly.com](mailto:info@roburitaly.com)

**1939**



**1950**



**1960**



**1970**



**1980**





Sovico (Monza Brianza)

## 3 UNIDADES DE PRODUÇÃO

- **Mais de 500** colaboradores

- **100,000** metros quadrados, dos quais **32,000 m<sup>2</sup>** área coberta

- **Mais de 10 milhões** unidades/ano



Castiglione d'Adda (Lodi)



Sulmona (L'Aquila)



# PESQUISA E DESENVOLVIMENTO

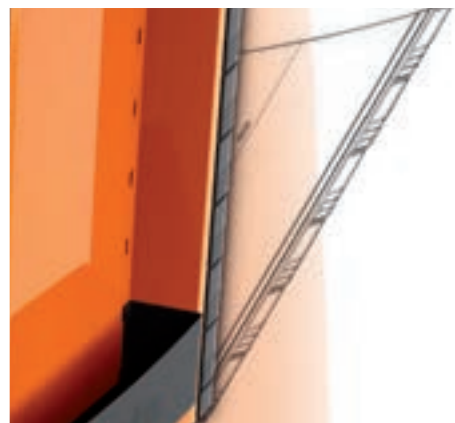

## Ergonomia, acabamento e design ao serviço da fiabilidade

Para a Beta, design não significa apenas aparência, mas acima de tudo um excelente desempenho. O estudo e design de uma ferramenta destinam-se a garantir a segurança, robustez e facilidade de utilização. É por isso que o design da ferramenta é baseado nas necessidades de utilização : funcionalidade leva a aparência e o design torna-se o resultado final de um estudo detalhado de materiais e acabamentos.

Com este objectivo em mente, a Beta renova constantemente o design dos seus produtos, revendo os seus componentes e materiais

*Inovação  
e qualidade: directrizes  
para o desenvolvimento de  
todos os novos projectos Beta.*





# CONTROLO E QUALIDADE



## Qualidade Beta, A nossa prova mais concreta

Na Beta, a qualidade tem um significado simples e concreto: “aquilo que satisfaz plenamente as necessidades e expectativas dos utilizadores profissionais que dependem dos nossos produtos como um instrumento de trabalho insubstituível”. As ferramentas não são apenas concebidas e fabricadas para satisfazer apenas uma necessidade, mas para garantir performances consistentes ao longo do tempo.

Na Beta, a qualidade significa mais do que uma mera política de fabrico e vendas atenta, englobando todos os departamentos da empresa no sentido de atingir metas cada vez mais ambiciosas em termos de satisfação do cliente. A Beta tem construído a sua história com base neste mesmo conceito.

## A qualidade das ferramentas Beta é uma sinergia entre técnicas tradicionais e novas tecnologias.



Desde 1995 os nossos processos de produção  
têm respeitado os padrões  
do Sistema de Qualidade  
ISO 9001

## GAMA DE PRODUTOS

### Mais de 12,000 referências

O dinamismo da empresa tem, ao longo dos anos, ajudado a actualizar de forma eficaz a sua gama de produtos para responder prontamente aos desafios do mercado global.

Actualmente a gama Beta Utensili inclui mais de 12,000 referências divididas em 26 famílias de produtos, tornando-a um dos nomes mais sonantes no mercado de ferramentas.

A Beta produz ferramentas para profissionais, desde a manutenção industrial à reparação de veículos, e para todos aqueles cujos hobbies são muito mais do que um simples passatempo.

# 26

famílias

*Cada necessidade  
profissional encontra  
uma solução eficaz*

## Aplicações



Automóvel



Energia



Indústria



Petrolífera & Gás



Aeronáutica

# www.beta-tools.com



Um site “fácil” e completo onde poderá encontrar os nossos catálogos actualizados, as últimas notícias, promoções e todas as informações técnicas (manuais de instruções, peças de substituição e vídeos de demonstração, que também pode encontrar no YouTube)



Uma aplicação específica de todos os catálogos Beta para Ipad e Android.



Autopromotec 2017

## APOIO ÀS VENDAS



A Beta dispõe de diferentes tipos de expositores oferecendo aos seus clientes soluções prontas a utilizar.



# DISTRIBUIÇÃO MUNDIAL

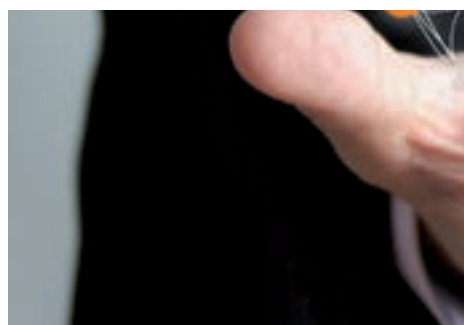

Presente em mais de  
**100 países**  
em todo o mundo



Beta **Brasil**



Beta **Benelux**



Beta **China**



Beta **France**



Beta **Iberia**



Beta **Polaska**



Beta **UK**



Beta **Hungary**



# 8

**Subsidiárias**





# LOGÍSTICA

**15,000 m<sup>2</sup>  
de superfície**

**Entregas  
rápidas,  
precisas e completas**



**12.000**  
referências  
e mais de **20.000**  
unidades de carga



### MOBILIÁRIO PARA OFICINA

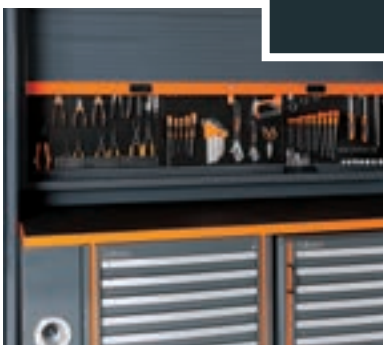

RSCSS

□ 330÷349

### JOGOS DE FERRAMENTAS E MALAS



□ 266÷325

□ 350÷435

### CHAVES DE CAIXA E ACESSÓRIOS



□ 18÷24

□ 29÷32

□ 95÷98

### CHAVES DE CAIXA E ACESSÓRIOS

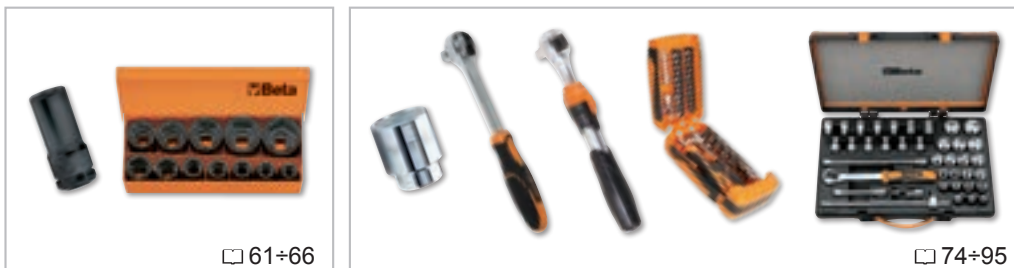

□ 61÷66

□ 74÷95

### CHAVES DINAMOMÉTRICAS E MULTIPLICADORES DE BINÁRIO

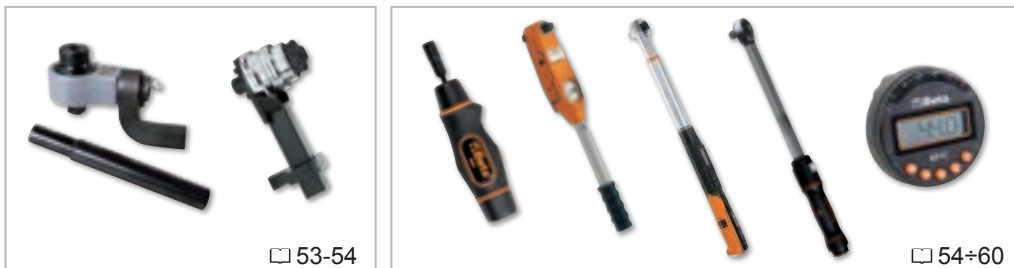

□ 53-54

□ 54÷60



## CHAVES DE PARAFUSOS, CHAVES EXTREMIDADE MACHO E PONTAS



## ALICATES E ALICATES DE CORTE



## MARTELOS E CINZÉIS



## FERRAMENTAS DE FURAR E ROSCAR



## EXTRACTORES







FERRAMENTAS ISOLADAS 1000V



☐ 240÷243

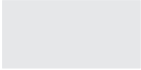

FERRAMENTAS EM AÇO INOX



☐ 240÷243



FERRAMENTAS ANTI-FAÍSCA



☐ 244÷251

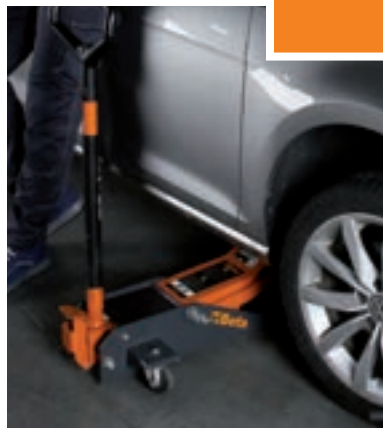

REPARAÇÃO DE VEÍCULOS



☐ 97÷106

☐ 140÷165

☐ 131÷136

☐ 196÷198

☐ 210÷218



FERRAMENTAS PARA MOTOCICLOS



☐ 219÷223



## FERRAMENTAS PARA BICICLETAS



☐ 224÷227



## FERRAMENTAS PNEUMÁTICAS E ACESSÓRIOS



☐ 254÷271



## FERRAMENTAS SEM FIO



☐ 252-253



## FERRAMENTAS ANTI-QUEDA



☐ 233÷239



## ROBUR ACESSÓRIOS PARA CABOS

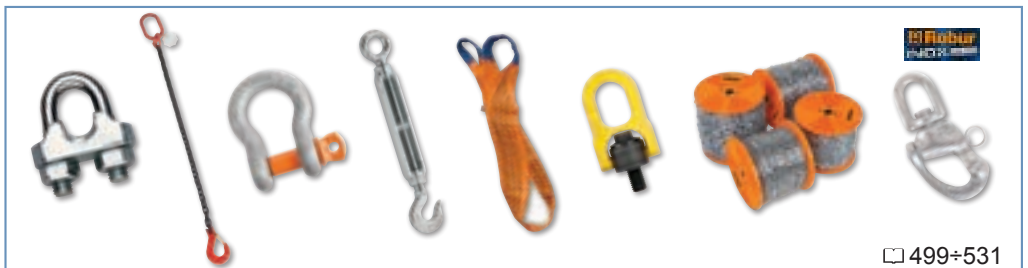

☐ 499÷531



## CALÇADO DE SEGURANÇA (E MEIAS TÉCNICAS)



☐ 460÷484



## VESTUÁRIO DE TRABALHO



☐ 485÷498



## EXPOSITORES PARA PONTOS DE VENDA

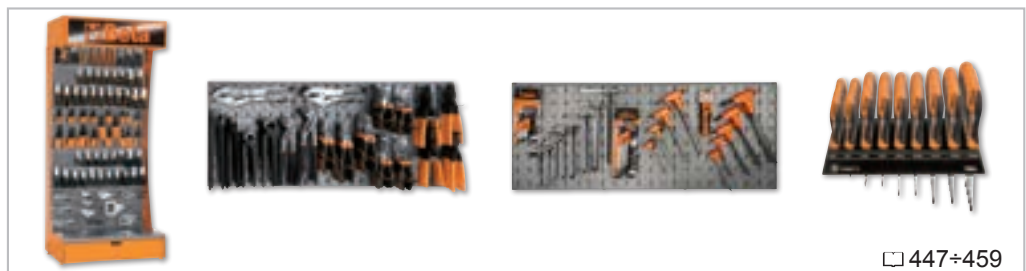

☐ 447÷459



## GAMA BLISTER



☐ 435÷446



## BETACOLLECTION



☐ 532÷541

# GUIA DE LEITURA

Referência

**42INOX**

Perfil da ferramenta



chave boca/luneta  
em aço inox

em blister



Preço unitário



Ferramentas  
para motociclos



Ferramentas  
para bicicletas



★ artigo disponível a pedido

• tamanho principal

○ encabadouro sextavado

Dimensão

Quantidade por caixa

Quantidade de peças  
por jogo

Símbolo da embalagem

Conteúdo da série

mm	L mm	€	Q	Código
6x6	95	12,60	2	000420306
7x7	105	12,90	2	000420307
8x8	116	13,10	2	000420308
9x9	127	14,20	2	000420309
10x10	137	15,10	2	000420310
11x11	148	15,90	2	000420311
12x12	158	16,60	2	000420312
13x13	169	16,80	2	000420313
14x14	180	17,40	2	000420314
15x15	190	18,00	2	000420315
16x16	201	18,60	2	000420316
17x17	212	20,80	2	000420317
18x18	222	22,40	2	000420318
19x19	233	24,00	2	000420319
21x21	254	30,00	1	000420321
22x22	264	31,50	1	000420322
24x24	285	34,00	1	000420324

Novidade 2019



Código

42INOX/S11 6-8-10-11-12-13- 14-15-16-17-19 mm	€ 189,00	Q 1	Código 000420391
---	----------	-----	------------------

Significado dos símbolos mais usados

Exemplo

• Em jogos

B	= Em bolsa plástica	42/B9
BV	= Bolsa plástica vazia	42/BV9
C	= Em caixa metálica	900/C11
D	= Em caixa expositora	1293/D6
S	= Em caixa de cartão	42/S17
SP	= Em expositor	42/SP17
SPV	= Expositor vazio	42/SPV1
SC	= com suporte compacto	96/SC9
SCV	= suporte compacto, vazio	96/SC9

Assortments

AS	= Com ferramentas em polegadas	5915VU/AS
E	= Para electrónica/electrotécnica	5980ET/A
I	= Para a hidráulica	5980ID
MT	= Para movimentação de terras	5902MT
U	= Para reparação universais	5915VU3
SBK	= Para reparação de motociclos	5940SBK
VG	= Para reparação auto	5904VG/5T
VI	= Para manutenção industrial	5902VI

Em chaves de caixa

A	= Perfil de 6 faces	910A
B	= Perfil de 12 faces	910B
ES	= Perfil dentado	920ES
FTX	= Parafusos TORX®	910FTX

Significado dos símbolos mais usados

Exemplo

PT	= Para parafusos com cabeça de 5 nervuras	910PT
X	= Roquete reversível em caixa metálica	920A/C12X

Em chaves para parafusos e pontas para aparafusadoras

LP	= Para parafusos de fenda	920LP
PE	= Para parafusos hexagonais	920PE
PH	= Para parafusos PHILLIPS®	920PH
PZ	= Para parafusos POZIDRIV® - SUPADRIV®	1299PZ
RTX	= Para parafusos TAMPER RESISTANT TORX®	1298RTX
SP	= Para parafusos SPANNER	861SP
TRW	= Para parafusos TRI-WING®	861TRW
TQS	= Para parafusos TORQ-SET®	861TQS
TX	= Para parafusos TORX®	920TX
XZN	= Para parafusos XZN®	920XZN

Na generalidade

AS	= Medidas em polegadas	42AS
BA	= Ferramenta anti-faísca	42BA
BM	= Punho com dois materiais	1150BM
C	= Caixa metálica vazia	C25
HS	= Ferramentas anti-queda	42HS
INOX	= ferramentas em aço inoxidável	42 INOX
L	= Modelo longo	952L
MQ	= Isolamento até 1000V	1150MQ
MP	= Cromado brilhante	42MP
R	= Peça de reposição	338R

Todas as informações e imagens que aparecem neste catálogo são meramente indicativas e sem qualquer valor contratual. A Beta Utensili reserva-se ao direito de alterar ou actualizar a sua gama de produtos sem aviso prévio, e sem obrigação de efectuar qualquer modificação sobre os modelos vendidos anteriormente.



**Beta** RECOMENDA

a utilização da ferramenta adequada à tarefa a desempenhar,  
respeitando as normas de segurança individual.





### 30

punções



Ø mm	L mm	€	🔧	📦
2	125	6,40	10	000300020
3	125	6,40	10	000300030
4	150	8,55	10	000300040
5	150	8,55	10	000300050
6	150	8,85	10	000300060

### 31

saca-troços



Ø mm	L mm	L1 mm	€	🔧	📦
2	110	22	6,35	10	000310002
3	128	35	6,55	10	000310003
4	146	45	8,10	10	000310004
5	164	55	8,55	10	000310005
6	182	65	10,70	5	000310006
8	200	80	11,50	5	000310008
10	220	95	14,40	5	000310010



31/B6



31/SP6

31/B6	58,50	1	000310020
2-3-4-5-6-8 mm			
42/BV6	6,65	1	000420051
31/SP6	60,00	1	000310030
2-3-4-5-6-8 mm			
31/SPV	10,90	1	000310031

### 31BM

saca-troços com punho



Ø mm	L mm	L1 mm	€	🔧	📦
2	168	42	13,00	2	000310402
3	180	52	13,60	2	000310403
4	191	62	14,70	2	000310404
5	200	72	15,30	2	000310405
6	221	82	17,80	2	000310406
8	235	94	18,60	2	000310408



31BM/D6	93,00	1	000310420
2-3-4-5-6-8 mm			

### 31L

saca-troços série longa



Ø mm	L mm	L1 mm	€	🔧	📦
4	175	80	9,60	5	000310104
5	175	80	10,20	5	000310105
6	175	80	12,30	5	000310106

### 31SE

saca-troços para cavilhas elásticas



Ø mm	D mm	L mm	L1 mm	€	🔧	📦
4	2,4	175	80	9,60	5	000310204
5	3,0	175	80	10,20	5	000310205
6	3,6	175	80	12,30	5	000310206



31/B6-LSE	71,50	1	000310320
31L: 4-5-6 mm			
31SE: 4-5-6 mm			
55/BV6	7,35	1	000550151

### 32

punções de bico



Ø mm	L mm	L1 mm	€	🔧	📦
3	100	44	5,90	10	000320100
4	125	52	7,20	10	000320125
5	150	62	8,95	10	000320150

### 32AU

punção de bico automático



Ø mm	L mm	L1 mm	€	🔧	📦
3	150	23	49,50	2	000320160

### 32AUR

ponteira de substituição



Ø mm	€	🔧	📦
3	8,75	5	000320170

### 34

escopros planos



L mm	A mm	L1 mm	€	🔧	📦
125	14,5	45	8,95	5	000340001
150	17,0	58	11,90	5	000340002
175	21,5	68	16,90	5	000340003

### 35

escopros planos série nervurada



L mm	A mm	€	🔧	📦
100	14,5	10,50	5	000350001
125	17,0	11,80	5	000350002
150	20,5	14,80	5	000350003
200	23,0	22,40	5	000350004
250	28,5	32,50	2	000350005
300	34,0	44,00	2	000350006

### 35PM

escopros planos série nervurada com punho de protecção



L mm	A mm	€	🔧	📦
200	23,0	33,50	2	000350014
250	28,5	43,50	2	000350015
300	34,0	56,00	2	000350016

### 35PMR

punhos de protecção



L mm	€	🔧	📦
200	10,90	1	000350024
250	10,90	1	000350025
300	12,00	1	000350026

### 36

buris série normal



L mm	A mm	L1 mm	€		
125	4	44	9,30	5	000360001
150	6	53	10,90	5	000360002

### 37

buris série nervurada



L mm	A mm	L1 mm	€		
150	6	45	16,90	5	000370001
200	8	55	24,60	3	000370002

### 37PM

buril nervurado com punho de protecção



L mm	A mm	€		
200	8	37,00	2	000370012

### 37PMR

punho de protecção de substituição



L mm	€		
200	12,00	1	000370022



38/B6



38/SP6

	€		
<b>38/B6</b>	58,50	1	000380006
30: 2-3 mm			
32: 4 mm			
34: 125-150 mm			
36: 150 mm			
<b>42/BV6</b>	6,65	1	000420051
<b>38/SP6</b>	60,00	1	000380009
30: 2-3 mm			
32: 4 mm			
34: 125-150 mm			
36: 150 mm			
<b>38/SPV</b>	10,90	1	000380019

### 42

chaves mistas boca/luneta



DIN 3113 UNI-ISO 7738

	L mm	€		
5,5x5,5	95	6,55	5	000420005
6x6	95	6,65	5	000420006
7x7	105	6,70	5	000420007
8x8	116	6,85	5	000420008
9x9	127	7,15	5	000420009
10x10	137	7,30	5	000420010
11x11	148	7,80	5	000420011
12x12	158	7,90	5	000420012
13x13	169	8,00	5	000420013
14x14	180	9,30	5	000420014
15x15	190	10,20	5	000420015
16x16	201	10,50	5	000420016
17x17	212	10,90	5	000420017
18x18	222	11,80	5	000420018
19x19	233	12,00	5	000420019
20x20	243	13,70	3	000420020
21x21	254	14,80	3	000420021
22x22	264	15,10	3	000420022
23x23	275	16,50	3	000420023
24x24	285	16,80	3	000420024
25x25	296	18,50	2	000420025
26x26	307	19,90	2	000420026
27x27	317	21,50	2	000420027
28x28	328	22,50	2	000420028
29x29	338	24,20	2	000420029
30x30	349	25,00	2	000420030
32x32	370	27,50	2	000420032
34x34	391	57,50	1	000420034
35x35	412	62,50	1	000420035
36x36	412	65,00	1	000420036
38x38	433	71,50	1	000420038
41x41	465	80,00	1	000420041



	€		
<b>42/B9</b>	83,00	1	000420064
6-7-8-10-11-13-14-17-19 mm			
<b>42/BV9</b>	8,40	1	000420056



	€		
<b>42/S14</b>	136,00	1	000420067
6-7-8-10-11-12-13-14-15-16-17-19-22-24 mm			
<b>42/S15</b>	190,00	1	000420066
6-7-8-10-11-12-13-14-17-19-22-24-27-30-32 mm			
<b>42/S17</b>	167,00	1	000420065
6-7-8-9-10-11-12-13-14-15-16-17-18-19-20-21-22 mm			
<b>42/S17X</b>	198,00	1	000420068
6-7-8-10-11-12-13-14-15-16-17-19-21-22-24-27-30 mm			
<b>42/S26</b>	359,00	1	000420070
6-7-8-9-10-11-12-13-14-15-16-17-18-19-20-21-22-23-24-25-26-27-28-29-30-32 mm			

### 42/SC9I-E

jogo de 9 chaves mistas, boca luneta, com suporte compacto



	€		
<b>42/SC9I</b>	87,00	1	000420087
8-10-11-12-13-14-15-17-19 mm			
<b>42/SCV9I</b>	8,95	1	000420103
<b>42/SC9E</b>	89,50	1	000420088
8-10-11-12-13-16-17-18-19 mm			
<b>42/SCV9E</b>	8,95	1	000420104



	€		
<b>42/SP25</b>	373,00	1	000420085
6-7-8-9-10-11-12-13-14-15-16-17-18-19-20-21-22-23-24-25-26-27-28-30-32 mm			
<b>42/SPV2</b>	41,50	1	000420090



42/SP15



42/SPV...

	€		
<b>42/SP15</b>	148,00	1	000420078
6-7-8-9-10-11-12-13-14-15-16-17-19-22-24 mm			
<b>42/SPV7</b>	6,15	1	000420097
<b>42:</b> 8-10-11-13-14-17-19 mm			
<b>55:</b> 6x7-8x9-10x11-12x13-14x15-16x17-18x19 mm			
<b>42/SPV11</b>	8,95	1	000420100
<b>42MP:</b> 8-9-10-11-12-13-14-15-16-17-19 mm			
<b>142-142SN:</b> 8-9-10-11-12-13-14-15-16-17-19 mm			
<b>42/SPV15</b>	12,40	1	000420102
<b>42:</b> 6-7-8-9-10-11-12-13-14-15-16-17-19-22-24 mm			

## 42AS

chaves mistas boca/luneta



mm	L mm	€	U	PC
1/4x1/4	95	8,00	2	000420106
9/32x9/32	106	8,10	2	000420107
5/16x5/16	116	8,20	2	000420108
3/8x3/8	137	8,80	2	000420110
7/16x7/16	148	9,60	2	000420111
1/2x1/2	169	9,90	2	000420113
9/16x9/16	180	10,80	2	000420114
19/32x19/32	191	12,10	2	000420115
5/8x5/8	201	12,70	2	000420116
11/16x11/16	212	13,50	2	000420117
3/4x3/4	233	14,50	2	000420119
13/16x13/16	254	17,10	2	000420121
7/8x7/8	264	17,70	2	000420122
15/16x15/16	285	20,20	2	000420124
1x1	296	21,30	2	000420125
1.1/16x1.1/16	317	23,30	2	000420127
1.1/8x1.1/8	338	25,50	2	000420129
1.1/4x1.1/4	370	32,00	2	000420132
1.5/16x1.5/16	391	59,00	1	000420133
1.3/8x1.3/8	412	68,00	1	000420135
1.7/16x1.7/16	412	70,00	1	000420136
1.1/2x1.1/2	433	74,50	1	000420138



€	U	PC
103,50	1	000420155

**42AS/B9**  
1/4-5/16-3/8-7/16-1/2  
9/16-5/8-11/16-3/4



€	U	PC
173,00	1	000420163

**42AS/13**  
1/4-5/16-3/8-7/16-1/2-9/16-5/8  
11/16-3/4-13/16-7/8-15/16-1

€	U	PC
253,00	1	000420166

**42AS/16**  
1/4-5/16-3/8-7/16-1/2-9/16-5/8  
11/16-3/4-13/16-7/8-15/16-1-1.1/16-1.1/8-1.1/4

€	U	PC
241,00	1	000420168

**42AS/17**  
1/4-9/32-5/16-3/8-7/16-1/2-  
9/16-19/32-5/8-11/16-3/4-  
13/16-7/8-15/16-1-1.1/16-1.1/8

## 42MP

chaves mistas boca/luneta em cromado brilhante



DIN 3113 UNI-ISO 7738

mm	L mm	€	U	PC
6x6	95	10,90	5	000420606
7x7	105	11,00	5	000420607
8x8	116	11,10	5	000420608
9x9	127	11,20	5	000420609
10x10	137	11,30	5	000420610
11x11	148	11,40	5	000420611
12x12	158	11,50	5	000420612
13x13	169	11,60	5	000420613
14x14	180	12,50	5	000420614
15x15	190	13,70	5	000420615
16x16	201	14,50	5	000420616
17x17	212	15,00	5	000420617
18x18	222	16,30	5	000420618
19x19	233	16,50	5	000420619
20x20	243	19,30	3	000420620
21x21	254	20,00	3	000420621
22x22	264	20,50	3	000420622
24x24	285	23,00	3	000420624
27x27	317	28,00	3	000420627
30x30	349	34,50	3	000420630
32x32	370	36,50	3	000420632



€	U	PC
119,00	1	000420651

**42MP/B9**  
6-7-8-10-11-13-14-17-19 mm

€	U	PC
8,40	1	000420056

**42/BV9**



€	U	PC
238,00	1	000420652

**42MP/S17**  
6-7-8-9-10-11-12-13-14-15  
16-17-18-19-20-21-22 mm

€	U	PC
360,00	1	000420653

**42MP/S21**  
6-7-8-9-10-11-12-13-14  
15-16-17-18-19-20-21-22  
24-27-30-32 mm

## 42LMP

chaves mistas boca/luneta série longa em cromado brilhante



mm	L mm	€	U	PC
8x8	148	9,75	2	000420508
9x9	167	10,10	2	000420509
10x10	172	10,40	2	000420510
11x11	186	10,90	2	000420511
12x12	197	11,20	2	000420512
13x13	207	11,40	2	000420513
14x14	223	12,20	2	000420514
15x15	233	13,40	2	000420515

mm	L mm	€	U	PC
16x16	243	14,40	2	000420516
17x17	261	15,40	2	000420517
18x18	270	16,70	2	000420518
19x19	280	17,20	2	000420519
21x21	301	19,90	2	000420521
22x22	318	20,40	2	000420522
24x24	338	23,70	2	000420524
27x27	376	27,50	2	000420527
30x30	394	34,50	2	000420530
32x32	435	38,00	2	000420532



€	U	PC
193,00	1	000420551

**42LMP/S14**  
8-9-10-11-12-13-14  
15-16-17-18-19-21-22 mm

€	U	PC
316,00	1	000420552

**42LMP/S18**  
8-9-10-11-12-13-14  
15-16-17-18-19-21-22  
24-27-30-32 mm

## 45

chaves mistas boca/luneta serviço pesado



DIN 3113 UNI-ISO 7738

mm	L mm	€	U	PC
46x46	520	197,00	1	000450046
50x50	560	229,00	1	000450050
55x55	610	326,00	1	000450055
60x60	660	444,00	1	000450060
65x65	710	522,00	1	000450065
70x70	760	584,00	1	000450070
75x75	810	663,00	1	000450075
80x80	860	797,00	1	000450080

## 52

chaves de boca simples



UNI 6733 DIN 3114

mm	L mm	€	U	PC
10	119	8,55	5	000520010
11	119	8,75	5	000520011
12	119	9,30	5	000520012
13	145	10,40	5	000520013
14	145	10,60	5	000520014
15	145	10,90	5	000520015
16	159	11,60	5	000520016
17	159	11,60	5	000520017
18	159	12,60	5	000520018
19	175	13,70	5	000520019
20	175	14,80	5	000520020
21	175	15,30	5	000520021
22	196	16,90	2	000520022
23	196	17,50	2	000520023
24	196	18,00	2	000520024
25	215	20,20	2	000520025
26	215	20,50	2	000520026
27	215	20,80	2	000520027
28	240	24,00	2	000520028
30	240	24,90	2	000520030
32	270	29,00	2	000520032



mm	L mm	€		
34	270	32,50	1	000520034
35	295	36,00	1	000520035
36	295	36,00	1	000520036
38	295	41,50	1	000520038
40	335	51,00	1	000520040
41	335	51,00	1	000520041
42	335	56,00	1	000520042
45	370	63,50	1	000520045
46	370	63,50	1	000520046
48	370	75,00	1	000520048
50	415	87,00	1	000520050
52	415	97,50	1	000520052
55	415	101,50	1	000520055
60	490	125,00	1	000520060
65	490	129,00	1	000520065
70	490	142,00	1	000520070

## 53

chaves de boca simples DIN 894



mm	L mm	€		
36	317	27,00	1	000530036
38	320	29,00	1	000530038
41	342	34,50	1	000530041
46	396	42,00	1	000530046
50	412	64,50	1	000530050
55	457	74,50	1	000530055
60	492	92,00	1	000530060
65	528	109,00	1	000530065
70	572	126,00	1	000530070
75	608	157,00	1	000530075
80	645	193,00	1	000530080
85	690	235,00	1	000530085
90	690	277,00	1	000530090
95	847	387,00	1	000530095
100	847	409,00	1	000530100
105	1000	507,00	1	000530105
110	1000	545,00	1	000530110
115	1000	611,00	1	000530115
120	1000	698,00	1	000530120
125	1000	807,00	1	000530125
130	1000	872,00	1	000530130
135	1000	927,00	1	000530135

## 55

chaves de bocas



UNI-ISO 10102 DIN 3110

mm	L mm	€		
4x5	101	4,20	5	000550003
5x5,5	101	4,80	5	000550006
5,5x7	120	4,80	5	000550009
6x7	120	3,70	5	000550012
7x8	140	4,80	5	000550018
8x9	140	3,80	5	000550021
8x10	140	4,80	5	000550024
10x11	155	4,05	5	000550030
10x12	155	5,50	5	000550033
10x13	170	6,05	5	000550035
12x13	170	4,50	5	000550042
12x14	170	6,25	5	000550045
13x14	185	6,95	5	000550047
13x17	189	7,40	5	000550051
14x15	185	5,70	5	000550054
14x17	189	8,05	5	000550057
16x17	202	6,40	5	000550060
17x19	220	8,75	2	000550063
18x19	220	7,65	2	000550066
19x22	236	10,10	2	000550069
20x22	236	8,65	2	000550075
21x23	245	9,40	2	000550078
22x24	245	10,90	2	000550081

mm	L mm	€		
24x26	262	10,90	2	000550087
24x27	262	12,30	2	000550090
25x28	272	12,60	2	000550096
27x29	284	14,40	2	000550099
27x30	284	16,70	2	000550102
27x32	297	18,00	2	000550105
30x32	297	15,80	2	000550108
32x36	325	60,00	1	000550114
34x36	325	60,00	1	000550117
35x38	375	66,50	1	000550120
36x41	375	69,00	1	000550123
41x46	425	80,00	1	000550129
46x50	475	98,50	1	000550132
50x55	500	115,00	1	000550135
55x60	500	124,00	1	000550138



	€		
55/B8 6x7-8x9-10x11-12x13 14x15-16x17-18x19 20x22 mm	51,50	1	000550158
55/BV8	8,40	1	000550159
55/B12 6x7-8x9-10x11-12x13 14x15-16x17-18x19 20x22-21x23-24x26 25x28-30x32 mm	104,00	1	000550162
55/BV12	13,70	1	000550163



	€		
55/S8 6x7-8x9-10x11-12x13 14x15-16x17-18x19 20x22 mm	44,50	1	000550174
55/S12 6x7-8x9-10x11-12x13 14x15-16x17-18x19 20x22-21x23-24x26 25x28-30x32 mm	93,00	1	000550178
55/S12X 6x7-8x9-10x11-12x13 14x15-16x17-18x19 20x22-21x23-24x27 25x28-30x32 mm	94,50	1	000550179
55/S13 6x7-8x9-10x11-12x13 14x15-16x17-18x19 20x22-21x23-24x26 25x28-27x29-30x32 mm	108,00	1	000550182



55/SP7



55/SP13

	€		
55/SP7 6x7-8x9-10x11-12x13 14x15-16x17-18x19 mm	38,00	1	000550167
42/SPV7 42: 8-10-11-13-14-17-19 mm 55: 6x7-8x9-10x11-12x13 14x15-16x17-18x19 mm	6,15	1	000420097
55/SP13 6x7-8x9-10x11-12x13 14x15-16x17-18x19 20x22-21x23-24x26 25x28-27x29-30x32 mm	130,00	1	000550186
55/SPV 27,00	27,00	1	000550190

## 55AS

chaves de bocas



	€			
1/4x9/32	120	5,05	2	000550203
1/4x5/16	120	5,05	2	000550206
5/16x11/32	140	5,35	2	000550209
5/16x3/8	140	5,35	2	000550212
3/8x7/16	155	5,80	2	000550215
7/16x1/2	170	6,35	2	000550218
1/2x9/16	170	6,80	2	000550221
9/16x5/8	185	7,65	2	000550224
19/32x11/16	189	9,20	2	000550227
5/8x11/16	202	9,20	2	000550230
5/8x3/4	202	10,40	2	000550233
11/16x13/16	220	10,80	2	000550242
3/4x7/8	236	11,70	2	000550245
25/32x13/16	236	11,70	2	000550244
7/8x15/16	245	12,60	2	000550251
15/16x1	262	15,90	1	000550257
1x1.1/8	272	16,80	1	000550259
1.1/16x1.1/4	284	21,90	1	000550267
1.1/8x1.5/16	297	21,90	1	000550266
1.5/16x1.1/2	325	71,00	1	000550269
1.3/8x1.1/2	375	78,50	1	000550272
1.7/16x1.5/8	375	78,50	1	000550275



	€		
55AS/5 5/16x11/32-3/8x7/16 1/2x9/16-5/8x11/16 3/4x7/8	39,00	1	000550290
55AS/8 1/4x9/32-5/16x11/32-3/8x7/16- 1/2x9/16-9/16x5/8-5/8x11/16- 11/16x13/16-3/4x7/8	62,50	1	000550296
55AS/12 1/4x9/32-5/16x11/32-3/8x7/16-1 2x9/16-9/16x5/8-5/8x11/16- 11/16x13/16-25/32x13/16-3/4x7/8- 15/16x1-1x1.1/8-1.1/16x1.1/4	129,00	1	000550298

Beta

## 55MP

chaves de bocas  
em cromado brilhante



UNI-ISO 10102 DIN 3110

Ø mm	L mm	€	U	U
6x7	120	4,95	2	000550603
8x9	140	5,40	2	000550606
10x11	155	5,85	2	000550609
12x13	170	6,50	2	000550612
14x15	185	7,65	2	000550615
16x17	202	9,00	2	000550618
18x19	220	10,60	2	000550621
20x22	236	12,20	2	000550624
21x23	245	13,10	2	000550627
24x26	262	15,30	1	000550630
25x28	272	16,20	1	000550633
27x29	284	19,40	1	000550636
30x32	297	21,20	1	000550639

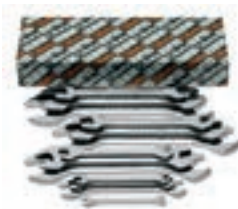

Ø	L	€	U	U
<b>55MP/S8</b>		62,50	1	000550650
6x7-8x9-10x11-12x13				
14x15-16x17-18x19				
20x22 mm				
<b>55MP/S13</b>		148,00	1	000550651
6x7-8x9-10x11-12x13				
14x15-16x17-18x19				
20x22-21x23-24x26				
25x28-27x29-30x32 mm				
<b>55MP/S12</b>		128,00	1	000550653
6x7-8x9-10x11-12x13-14x15-				
16x17-18x19-20x22-21x23-24x26-				
25x28-30x32 mm				

## 58

chaves de boca, série pancada



DIN 133

Ø mm	L mm	€	U	U
24	177	27,00	1	000580024
27	180	28,50	1	000580027
30	190	32,00	1	000580030
32	190	33,00	1	000580032
34	200	42,00	1	000580034
36	215	43,50	1	000580036
41	235	52,00	1	000580041
46	255	69,50	1	000580046
50	275	77,00	1	000580050
55	300	92,50	1	000580055
60	320	101,50	1	000580060
65	342	132,00	1	000580065
70	375	172,00	1	000580070
75	375	189,00	1	000580075
80	408	265,00	1	000580080
85	408	299,00	1	000580085
90	445	350,00	1	000580090
95	445	361,00	1	000580095
100	485	507,00	1	000580100
105	485	569,00	1	000580105

Ø mm	L mm	€	U	U
110	510	621,00	1	000580110
115	510	716,00	1	000580115
120	545	733,00	1	000580120
125	545	840,00	1	000580125
130	575	1.123,00	1	000580130
135	575	1.183,00	1	000580135
*140	575	1.280,00	1	000580140
*145	640	1.775,00	1	000580145
*150	640	1.830,00	1	000580150
*155	640	1.955,00	1	000580155
*160	640	2.165,00	1	000580160
*165	715	2.335,00	1	000580165
*170	715	3.170,00	1	000580170
*175	715	3.350,00	1	000580175
*180	715	3.630,00	1	000580180
*185	715	3.730,00	1	000580185
*190	800	4.090,00	1	000580190
*195	800	4.320,00	1	000580195
*200	800	4.510,00	1	000580200
*210	800	5.630,00	1	000580210
*220	800	7.350,00	1	000580220
*230	800	9.000,00	1	000580230

## 73

chaves de bocas  
de pequenas dimensões



UNI 6737

Ø mm	L mm	€	U	U
4x4	78	7,65	5	000730040
4,5x4,5	78	7,65	5	000730045
5x5	78	7,65	5	000730050
5,5x5,5	86	8,35	5	000730055
6x6	86	8,35	5	000730060
7x7	86	8,35	5	000730070
8x8	97	8,70	5	000730080
9x9	97	8,70	5	000730090
10x10	108	9,30	5	000730100
11x11	108	9,30	5	000730110
12x12	124	10,70	5	000730120
13x13	124	10,70	5	000730130
14x14	124	10,70	5	000730140



Ø	L	€	U	U
<b>73/B13</b>		124,00	1	000730200
4-4,5-5-5,5-6-7-8-9				
10-11-12-13-14 mm				
<b>73/BV</b>		7,85	1	000730201

Ø	L	€	U	U
<b>73/S13</b>		116,00	1	000730210
4-4,5-5-5,5-6-7-8-9				
10-11-12-13-14 mm				

 **Beta**

## 78

chaves de luneta de 12 faces  
série pancada



DIN 7444

Ø mm	L mm	€	U	U
24	162	28,00	1	000780024
27	180	33,00	1	000780027
30	190	39,50	1	000780030
32	190	40,50	1	000780032
36	205	51,50	1	000780036
41	225	66,00	1	000780041
46	235	75,00	1	000780046
50	250	88,00	1	000780050
55	265	100,50	1	000780055
60	275	121,00	1	000780060
65	295	155,00	1	000780065
70	325	158,00	1	000780070
75	325	187,00	1	000780075
80	350	283,00	1	000780080
85	350	307,00	1	000780085
90	390	375,00	1	000780090
95	390	434,00	1	000780095
100	420	491,00	1	000780100
105	420	564,00	1	000780105
110	450	626,00	1	000780110
115	450	709,00	1	000780115
120	490	992,00	1	000780120
125	480	1.330,00	1	000780125
130	520	1.525,00	1	000780130
135	520	1.650,00	1	000780135
*140	520	1.885,00	1	000780140
*145	580	2.370,00	1	000780145
*150	580	2.480,00	1	000780150
*155	580	2.780,00	1	000780155
*160	650	2.860,00	1	000780160
*165	650	3.060,00	1	000780165
*170	650	3.730,00	1	000780170
*175	650	4.030,00	1	000780175
*180	650	4.400,00	1	000780180
*185	695	4.550,00	1	000780185
*190	695	4.870,00	1	000780190
*195	695	4.920,00	1	000780195
*200	695	5.040,00	1	000780200
*210	740	5.320,00	1	000780210
*215	740	6.030,00	1	000780215
*220	740	6.680,00	1	000780220
*230	740	8.310,00	1	000780230

## 78AS

chave de luneta de pancada



Ø	L	€	U	U
*1.1/16	180	39,50	1	000780327
*1.1/8	190	39,50	1	000780329
*1.3/16	190	39,50	1	000780330
*1.1/4	197	43,50	1	000780332
*1.5/16	197	43,50	1	000780333
*1.3/8	223	47,50	1	000780335
*1.7/16	223	57,00	1	000780336
*1.1/2	223	57,00	1	000780338
*1.5/8	223	66,50	1	000780341
*1.11/16	225	70,00	1	000780343
*1.13/16	240	77,00	1	000780346
*1.7/8	250	77,00	1	000780348
*2	250	89,50	1	000780350
*2.1/16	250	93,00	1	000780352
*2.3/16	275	97,50	1	000780355
*2.3/8	270	130,00	1	000780360
*2.9/16	302	145,00	1	000780365
*2.3/4	350	156,00	1	000780370
*2.15/16	350	179,00	1	000780375
*3.1/8	354	294,00	1	000780380

## 80

chaves de caixa articuladas com 12 faces



mm	L mm	€	U	IT
6x7	170	31,50	3	000800006
8x9	176	31,50	3	000800008
8x10	179	31,50	3	000800009
10x11	182	33,50	3	000800010
12x13	228	37,50	3	000800012
14x15	232	38,50	3	000800014
13x17	231	41,00	3	000800015
16x17	234	41,00	2	000800016
18x19	285	50,00	2	000800018
19x22	287	52,00	2	000800019
20x22	289	52,00	2	000800020
21x23	289	53,00	2	000800021
24x27	405	87,50	2	000800024
30x32	413	93,00	2	000800030

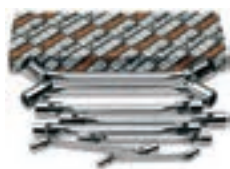

€	U	IT
80/S8	313,00	1 000800051
6x7-8x9-10x11-12x13-14x15-16x17-18x19-20x22 mm		
80/S11	545,00	1 000800056
6x7-8x9-10x11-12x13-14x15-16x17-18x19-20x22-21x23-24x27-30x32 mm		

## 83

chaves curvas de lunetas para motores de arranque



ISO 3318

mm	L mm	€	U	IT
8x10	126	14,80	3	000830008
10x12	137	15,30	3	000830010
11x13	138	15,90	3	000830011
14x17	183	20,20	3	000830014
15x17	184	22,90	2	000830015
16x18	196	25,00	2	000830016
19x22	231	33,00	2	000830019



€	U	IT
83/S3	69,00	1 000830081
11x13-14x17-19x22 mm		
83/S5	112,00	1 000830085
10x12-11x13-15x17-16x18-19x22 mm		

## 83AS

chaves curvas de lunetas para motores de arranque



mm	L mm	€	U	IT
7/16x1/2	138	19,10	2	000830111
9/16x5/8	183	22,90	2	000830114
3/4x7/8	230	36,00	2	000830119



€	U	IT
83AS/3	78,00	1 000830181
7/16x1/2-9/16x5/8-3/4x7/8		

## 88

chaves de luneta duplas direitas, série extralonga



mm	L mm	€	U	IT
8x10	235	16,90	2	000880008
12x14	330	20,20	2	000880012
13x15	330	20,20	2	000880013
16x18	405	28,50	2	000880016
17x19	405	28,50	2	000880017
21x23	435	33,00	2	000880021
22x24	435	33,00	2	000880022



€	U	IT
88/S7	179,00	1 000880107
8x10-12x14-13x15-16x18-17x19-21x23-22x24 mm		

## 90

chaves de lunetas com curvatura profunda



DIN 838 ISO 10104

mm	L mm	€	U	IT
6x7	165	8,75	5	000900006
8x9	180	9,40	5	000900012
8x10	180	10,90	5	000900015
10x11	195	10,20	5	000900018
10x12	195	11,20	5	000900021
11x13	215	12,40	5	000900024
12x13	215	11,30	5	000900027
12x14	215	12,90	5	000900030
14x15	230	12,00	5	000900033
14x17	250	15,30	5	000900036
16x17	250	14,10	5	000900039
17x19	265	18,10	5	000900042
18x19	265	16,40	5	000900045
19x22	285	20,40	3	000900048
20x22	285	18,60	3	000900051
21x23	305	21,00	2	000900057
22x24	305	23,20	2	000900060
24x26	325	23,70	2	000900063
24x27	325	26,00	2	000900067
25x28	340	28,50	2	000900070
27x29	355	31,00	2	000900073
27x30	355	34,00	2	000900076
27x32	375	37,50	2	000900078
30x32	375	34,00	2	000900080
32x36	395	51,50	1	000900088
34x36	415	60,00	1	000900089
35x38	415	60,50	1	000900091
36x41	435	69,00	1	000900094
41x46	460	101,50	1	000900097
46x50	500	137,00	1	000900100



€	U	IT
90/B8	112,00	1 000900154
6x7-8x9-10x11-12x13-14x15-16x17-18x19-20x22 mm		
90/BV8	11,50	1 000900155

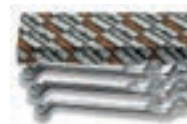

€	U	IT
90/S8	100,50	1 000900162
6x7-8x9-10x11-12x13-14x15-16x17-18x19-20x22 mm		
90/S12	208,00	1 000900166
6x7-8x9-10x11-12x13-14x15-16x17-18x19-20x22-21x23-24x26-25x28-30x32 mm		
90/S12X	210,00	1 000900167
6x7-8x9-10x11-12x13-14x15-16x17-18x19-20x22-21x23-24x27-25x28-30x32 mm		
90/S13	238,00	1 000900170
6x7-8x9-10x11-12x13-14x15-16x17-18x19-20x22-21x23-24x26-25x28-27x29-30x32 mm		



<b>90/SP13</b>	€ 265,00	1	000900174
6x7-8x9-10x11-12x13			
14x15-16x17-18x19			
20x22-21x23-24x26			
25x28-27x29-30x32 mm			
<b>55/SPV</b>	€ 27,00	1	000550190

## 90AS

chaves de lunetas com curvatura profunda



mm	L mm	€		
1/4x5/16	165	10,30	2	000900203
5/16x11/32	180	10,90	2	000900206
5/16x3/8	180	11,30	2	000900209
3/8x7/16	195	11,50	2	000900212
7/16x1/2	215	12,90	2	000900215
1/2x9/16	230	14,80	2	000900218
9/16x5/8	230	14,80	2	000900221
19/32x11/16	250	16,10	2	000900222
5/8x11/16	250	16,60	2	000900224
5/8x3/4	265	19,50	2	000900227
11/16x3/4	265	19,50	1	000900230
11/16x13/16	265	19,50	1	000900233
3/4x25/32	265	22,40	1	000900235
3/4x7/8	285	22,40	1	000900237
13/16x7/8	285	22,90	1	000900240
7/8x15/16	305	22,90	1	000900243
15/16x1	325	27,50	1	000900252
1.1/16x1.1/4	375	40,00	1	000900258
1.1/8x1.5/16	375	40,00	1	000900261



<b>90AS/8</b>	€ 134,00	1	000900298
1/4x5/16-5/16x11/32			
3/8x7/16-1/2x9/16			
5/8x11/16-11/16x3/4			
13/16x7/8-15/16x1			
<b>90AS/10</b>	€ 214,00	1	000900300
1/4x5/16-5/16x11/32			
3/8x7/16-1/2x9/16			
5/8x11/16-11/16x3/4			
13/16x7/8-15/16x1			
1.1/16x1.1/4-1.1/8x1.5/16			

## 91

chaves de luneta inclinada para serviços pesados



mm	Ø mm	€		
24	38	51,00	1	000910024
27	41	52,00	1	000910027
30	48	56,00	1	000910030
32	49	60,00	1	000910032
36	54	68,50	1	000910036
41	62	82,00	1	000910041
46	69	95,00	1	000910046
50	76	108,50	1	000910050
55	81	120,00	1	000910055
60	90	150,00	1	000910060
65	98	168,00	1	000910065
70	105	190,00	1	000910070
75	110	214,00	1	000910075
80	125	246,00	1	000910080
85	125	257,00	1	000910085
90	140	469,00	1	000910090
95	140	513,00	1	000910095
100	143	542,00	1	000910100
105	146	595,00	1	000910105

## 92

cabo tubular para a chave ref. 91



L mm	91 mm	Ø mm	€		
92/1	460	24÷30	19	30,00	1 000920010
92/2	610	32÷41	22	46,00	1 000920020
92/3	760	46÷55	25	66,50	1 000920030
92/4	860	60÷105	30	87,50	1 000920040

## 93

chave de lunetas com curvatura profunda especial para andaimes



mm	L mm	€		
21x22	310	35,00	3	000930021

## 93C

roquete de dupla face, com curvatura, para parafusos de andaimes



mm	L mm	€		
17x19	310	41,50	1	000930117
19x22	310	45,00	1	000930119
19x24	310	54,00	1	000930120
21x22	365	51,00	1	000930121
36x38	445	84,50	1	000930136

## 94

chaves de lunetas abertas



DIN 3118

mm	L mm	€		
8x10	140	15,30	2	000940008
9x11	153	16,00	2	000940009
10x11	153	16,50	2	000940010
11x13	175	17,10	2	000940011
12x14	175	18,30	2	000940012
13x15	175	18,30	2	000940013
14x15	175	21,60	2	000940014
14x17	195	22,20	2	000940015
17x19	212	22,70	2	000940017
19x22	228	24,50	2	000940019
22x24	242	30,00	2	000940022
24x27	260	32,50	2	000940024
30x32	300	41,50	2	000940030
36x41	320	68,50	1	000940036



<b>94/S6</b>	€ 114,00	1	000940050
8x10-10x11-11x13-12x14			
17x19-19x22 mm			
<b>94/S10</b>	€ 234,00	1	000940052
8x10-9x11-10x11-11x13			
12x14-17x19-19x22			
22x24-24x27-30x32 mm			

## 95

chaves de lunetas direitas



DIN 837 ISO 10103

mm	L mm	€		
6x7	120	9,85	3	000950161
8x9	135	10,50	3	000950162
10x11	150	12,00	3	000950163
12x13	165	13,10	3	000950164
14x15	185	13,70	3	000950165
16x17	210	14,80	3	000950166
17x19	225	16,90	3	000950167
18x19	225	16,90	2	000950168
20x22	240	19,20	2	000950169
21x23	255	20,30	2	000950170
24x26	270	21,50	2	000950171
25x28	285	26,00	2	000950172
27x29	315	26,50	2	000950173
30x32	335	30,00	2	000950174



<b>95/S8</b>	€ 110,00	1	000950177
6x7-8x9-10x11-12x13			
14x15-16x17-18x19			
20x22 mm			
<b>95/S13</b>	€ 234,00	1	000950179
6x7-8x9-10x11-12x13			
14x15-16x17-18x19			
20x22-21x23-24x26			
25x28-27x29-30x32 mm			

**Beta**

## 95FTX

chaves de lunetas direitas,  
para parafusos com perfil Torx®



	L mm	€	🔧	📦
E6xE8	115	10,30	2	000950306
E10xE12	143	10,80	2	000950310
E14xE18	177	12,00	2	000950314
E20xE24	224	16,10	2	000950320

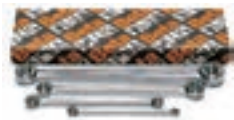

	€	🔧	📦
95FTX/S4 E6xE8-E10xE12 E14xE18-E20xE24	49,50	1	000950325

## 96

chaves macho hexagonal  
cromadas



ISO 2936

mm	L mm	L1 mm	€	🔧	📦
0,9	35	8	0,90	20	000960013
1,3	39	10	0,90	20	000960014
1,5	45	15	0,90	20	000960015
2	50	17	0,95	20	000960020
2,5	57	20	0,95	20	000960025
3	64	22	1,10	20	000960030
3,5	68	25	1,30	20	000960035
4	72	28	1,35	20	000960040
4,5	78	30	1,40	20	000960045
5	83	32	1,50	20	000960050
5,5	88	35	1,80	20	000960055
6	94	37	1,80	20	000960060
7	99	40	2,25	10	000960070
8	105	43	2,65	10	000960080
9	111	46	3,15	10	000960090
10	119	49	3,75	10	000960100
11	126	52	4,60	10	000960110
12	134	56	5,55	10	000960120
13	142	62	7,20	10	000960130
14	151	69	8,40	10	000960140
16	165	75	12,00	5	000960160
17	174	79	13,00	5	000960170
19	196	88	18,00	5	000960190
22	216	100	28,00	3	000960220
24	242	112	37,50	1	000960240
27	271	125	50,50	1	000960270
30	309	140	67,50	1	000960300
32	341	155	89,50	1	000960312
36	385	174	129,00	1	000960316



	€	🔧	📦
96/ST6 2,5-3-4-5-6-8 mm	13,00	3	000960370



	€	🔧	📦
96/BGS7 1,5-2-2,5-3-4-5-6 mm	28,00	1	000960367



	€	🔧	📦
96/BG7 2,5-3-4-5-6-8-10 mm	30,00	1	000960368



	€	🔧	📦
96/B8 2-2,5-3-4-5-6-8-10 mm	15,50	5	000960386
96/B10 1,5-2-2,5-3-4-5-6-8-10-12 mm	22,00	5	000960380
96N/BV	1,65	1	000960651



	€	🔧	📦
96/SC9 1,5-2-2,5-3-4-5-6-8-10 mm	18,60	1	000960374
96/SCV	3,85	1	000960985



	€	🔧	📦
96/SC12 2-2,5-3-3,5-4-4,5-5-6-7-8-9-10 mm	26,00	1	000960395
96/SCV12	4,40	1	000960975



## 96N

chaves macho hexagonal, brunidas



ISO 2936

mm	L mm	L1 mm	€	🔧	📦
0,9	32	10	0,45	20	000960409
1,3	44	12	0,45	20	000960413
1,5	46	15	0,45	20	000960415
2	51	17	0,50	20	000960420
2,5	57	20	0,50	20	000960425
3	64	22	0,55	20	000960430
3,5	68	25	0,70	20	000960435
4	72	28	0,80	20	000960440
4,5	78	30	0,85	20	000960445
5	83	32	0,90	20	000960450
6	94	37	1,10	20	000960460
7	99	40	1,50	10	000960470
8	105	43	1,75	10	000960480
9	111	46	2,30	10	000960490
10	119	49	2,75	10	000960500
11	126	52	3,35	10	000960510
12	134	56	4,05	10	000960520
13	142	62	5,40	10	000960530
14	151	69	6,05	10	000960540
16	165	72	9,30	5	000960560
17	174	79	9,95	5	000960570
19	194	88	13,60	5	000960590
22	216	99	24,80	1	000960592
24	242	111	33,00	1	000960594



	€	🔧	📦
96N/ST6 2,5-3-4-5-6-8 mm	9,25	3	000960640



	€	🔧	📦
96N/G7 2,5-3-4-5-6-8-10 mm	22,90	3	000960645
96N/G7A 1,5-2-2,5-3-4-5-6 mm	15,90	3	000960643



	€	🔧	📦
96N/B10 1,5-2-2,5-3-4-5-6-8-10-12 mm	14,90	5	000960650
96N/BV	1,65	1	000960651





<b>96N/SC9</b> 1,5-2-2,5-3-4-5-6-8-10 mm	€ 13,00	1	000960644
<b>96N/SCV</b>	3,85	1	000960986



<b>96N/SC12</b> 2-2,5-3-3,5-4-4,5-5-6-7-8-9-10 mm	€ 18,40	1	000960661
<b>96N/SCV12</b>	4,40	1	000960976

### 96C/AS

chaves de aperto sextavadas, cromadas



"	L mm	L1 mm	g	€		
1/16	46	16	1,01	1,60	20	000961702
3/32	53	19	2,70	2,20	20	000961706
1/8	60	22	5,33	2,30	20	000961710
5/32	67	25	9,33	2,70	20	000961714
3/16	74	28	14,87	3,10	20	000961716
7/32	81	32	22,00	3,45	20	000961718
1/4	89	35	31,40	3,85	20	000961720
5/16	103	40	56,16	4,30	10	000961724
3/8	117	45	91,31	5,05	10	000961728



<b>96C-AS/SC9</b> 1/16-3/32-1/8-5/32-3/16-7/32-1/4-5/16-3/8	€ 32,50	1	000961753
--	---------	---	-----------



### 96AS

chaves macho hexagonal, brunidas



"	L mm	L1 mm	€		
1/30 (0,035")	44	14	0,80	20	000960698
1/20 (0,050")	44	15	0,80	20	000960701
1/16	46	16	0,90	20	000960702
5/64	50	18	1,05	20	000960704
3/32	53	19	1,20	20	000960706
7/64	57	21	1,30	20	000960708
1/8	60	22	1,30	20	000960710
9/64	64	24	1,55	20	000960712
5/32	68	25	1,55	20	000960714
3/16	75	29	1,70	20	000960716
7/32	82	32	1,95	20	000960718
1/4	89	35	2,25	20	000960720
5/16	103	40	2,75	10	000960724
3/8	117	44	3,40	10	000960728
7/16	132	49	4,95	10	000960730
1/2	149	54	6,20	10	000960732
9/16	151	69	10,10	2	000960734
5/8	165	72	12,40	1	000960736
3/4	194	88	20,20	1	000960738



<b>96AS/SC9</b> 1/16-3/32-1/8-5/32-3/16-7/32-1/4-5/16-3/8	€ 20,70	1	000960743
<b>96AS/SCV</b>	3,85	1	000960744



<b>96AS/T7</b> 3/32-1/8-5/32-3/16-7/32-1/4-5/16	€ 17,30	3	000960740
--	---------	---	-----------



<b>96AS/G7</b> 3/32-1/8-5/32-3/16-1/4-5/16-3/8	€ 24,00	3	000960745
---	---------	---	-----------



<b>96AS/BG7</b> 3/32-1/8-5/32-3/16-1/4-5/16-3/8	€ 29,50	1	000960747
--	---------	---	-----------



<b>96AS/B11</b> 1/20-1/16-5/64-3/32-1/8-5/32-3/16-7/32-1/4-5/16-3/8	€ 20,30	1	000960749
<b>96N/BV</b>	1,65	1	000960651

### 96LC

chaves macho hexagonal série longa, cromadas



ISO 2936

mm	L mm	L1 mm	€		
2	101	17	1,65	20	000960320
2,5	113	20	1,75	20	000960321
3	127	22	1,95	20	000960322
3,5	138	25	2,00	20	000960323
4	142	28	2,15	20	000960324
4,5	154	28	2,55	20	000960325
5	163	32	2,75	20	000960326
6	184	37	2,95	20	000960327
7	194	40	3,40	10	000960328
8	205	43	4,15	10	000960329
9	216	46	4,60	10	000960330
10	231	49	5,95	10	000960331
12	259	56	7,50	10	000960332



<b>96LC/SC8</b> 2-2,5-3-4-5-6-8-10 mm	€ 27,00	1	000960334
<b>96LC/SCV</b>	3,85	1	000960983



<b>96LC/SC12</b> 2-2,5-3-3,5-4-4,5-5-6-7-8-9-10 mm	€ 40,00	1	000960337
<b>96LC/SCV12</b>	4,40	1	000960977



## 96L

chaves macho hexagonal  
série longa, brunidas



ISO 2936

mm	L mm	L1 mm	€	🔧	📦
2	99	15	1,20	20	000960820
2,5	110	17	1,25	20	000960825
3	124	19	1,40	20	000960830
3,5	135	21	1,50	20	000960835
4	138	24	1,65	20	000960840
4,5	150	25	1,95	20	000960845
5	158	27	2,05	20	000960850
6	178	31	2,30	20	000960860
7	187	33	2,90	10	000960870
8	197	35	3,70	10	000960880
9	207	37	4,15	10	000960890
10	221	39	5,55	10	000960900
12	247	44	6,90	10	000960920



<b>96L/SC8</b> 2-2,5-3-4-5-6-8-10 mm	€ 22,70	🔧 1	📦 000960924
<b>96L/SCV</b>	3,85	🔧 1	📦 000960987



<b>96L/SC12</b> 2-2,5-3-3,5-4-4,5-5-6-7-8-9-10 mm	€ 34,00	🔧 1	📦 000960929
<b>96L/SCV12</b>	4,40	🔧 1	📦 000960978

## 96BPC

chaves macho hexagonal  
com uma extremidade esférica, cromadas

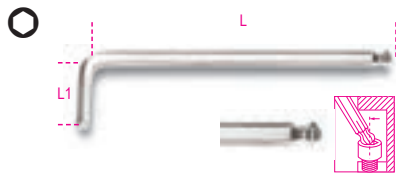

mm	L mm	L1 mm	€	🔧	📦
1,5	79	13	2,00	10	000960340
2	84	15	2,10	10	000960341
2,5	89	17	2,20	10	000960342
3	99	19	2,35	10	000960343
4	108	24	2,70	10	000960344
5	126	27	3,30	10	000960345
6	148	31	4,70	10	000960346
7	157	33	6,20	5	000960353
8	168	35	6,30	5	000960347
10	187	39	10,20	5	000960348
12	220	55	12,40	5	000960352



<b>96BPC/SC9</b> 1,5-2-2,5-3-4-5-6-8-10 mm	€ 39,50	🔧 1	📦 000960354
<b>96BPC/SCV</b>	3,85	🔧 1	📦 000960984

## 96BP

chaves macho hexagonal com uma  
extremidade esférica, brunidas

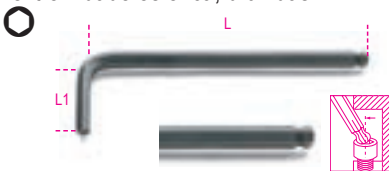

mm	L mm	L1 mm	€	🔧	📦
1,5	79	13	1,50	10	000960960
2	84	15	1,60	10	000960961
2,5	89	17	1,65	10	000960962
3	99	19	1,70	10	000960963
4	108	24	2,00	10	000960965
5	126	27	2,65	10	000960967
6	148	31	3,85	10	000960968
8	168	35	5,35	5	000960970
10	187	39	9,40	5	000960972
12	220	55	13,50	5	000960973



<b>96BP/SC9</b> 1,5-2-2,5-3-4-5-6-8-10 mm	€ 33,50	🔧 1	📦 000960974
<b>96BP/SCV</b>	3,85	🔧 1	📦 000960988

## 96LBP

chave sextavada ponta de bola, modelo extra  
longo



mm	L mm	L1 mm	€	🔧	📦
1,5	90	15	2,25	5	000961340
2	100	17	2,35	5	000961341
2,5	112	20	2,55	5	000961342
3	127	22	2,65	5	000961343
4	144	27	3,30	5	000961344
5	163	32	3,95	5	000961345
6	184	37	5,35	5	000961346
8	204	44	7,35	2	000961348
10	230	49	11,90	2	000961350



<b>96LBP/SC9</b> 1,5-2-2,5-3-4-5-6-8-10 mm	€ 45,50	🔧 1	📦 000961354
<b>96LBP/SCV</b>	3,85	🔧 1	📦 000961984

## 96BP/AS

chaves macho hexagonal  
com uma extremidade esférica, brunidas

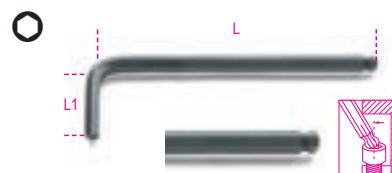

"	L mm	L1 mm	€	🔧	📦
3/32	89	17	1,80	10	000960989
1/8	98	18	1,95	10	000960990
5/32	108	24	2,30	10	000960991
3/16	126	26	2,65	10	000960992
7/32	139	28	3,85	10	000960993
1/4	152	31	4,15	10	000960994
5/16	168	34	5,40	5	000960995
3/8	190	39	9,25	5	000960996



<b>96BP-AS/SC9</b> 1/16-3/32-1/8-5/32-3/16-7/32-1/4-5/16-3/8	€ 36,00	🔧 1	📦 000961000
<b>96BP-AS/SCV</b>	3,85	🔧 1	📦 000961001



<b>96BP-AS/8</b> 3/32-1/8-5/32-3/16-7/32-1/4-5/16-3/8	€ 33,00	🔧 1	📦 000960997
<b>96BP-AS/BV</b>	1,65	🔧 1	📦 000960998



## 96BPA

chave sextavada ponta de bola, 110°, modelo extra curto



mm	L mm	L1 mm	€	U	PC
1,5	71	9	2,20	5	000961960
2	86	11	2,30	5	000961961
2,5	96	13	2,40	5	000961962
3	104	15	2,65	5	000961963
4	116	17	3,20	5	000961964
5	132	19	3,75	5	000961965
6	155	21	5,35	5	000961966
8	176	24	7,15	2	000961968
10	200	27	11,20	2	000961970



96BPA/SC9	44,00	1	000961974
1,5-2-2,5-3-4-5-6-8-10 mm			
96BPA/SCV	3,85	1	000961988

## 96T

chaves macho hexagonal com punho

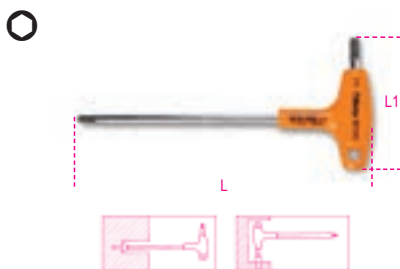

mm	L mm	L1 mm	€	U	PC
2	139	52	10,40	5	000960934
2,5	153	55	10,40	5	000960935
3	153	55	10,70	5	000960936
3,5	179	70	11,20	5	000960937
4	179	70	11,20	5	000960938
4,5	200	84	11,40	5	000960939
5	200	84	11,40	5	000960940
6	221	103	13,00	5	000960941
7	236	106	14,20	3	000960942
8	255	117	16,40	3	000960943
10	285	132	18,60	3	000960945



96T/S6	67,50	1	000960952
2-2,5-3-4-5-6 mm			
96T/S8	102,00	1	000960933
2-2,5-3-4-5-6-8-10 mm			
96T/S11	139,00	1	000960951
2-2,5-3-3,5-4-4,5-5-6-7-8-10 mm			



96T/SP11	151,00	1	000960957
2-2,5-3-3,5-4-4,5-5-6-7-8-10 mm			
96T/SPV	14,80	1	000960958
96T/S11			
97TTX/S11			

## 96T/AS

chaves macho hexagonal com punho



"	L mm	L1 mm	€	U	PC
3/32	153	55	12,80	2	000960669
7/64	153	55	12,80	2	000960670
1/8	179	70	13,00	2	000960671
9/64	179	70	13,60	2	000960672
5/32	200	84	13,60	2	000960673
3/16	200	84	13,60	2	000960674
7/32	221	103	15,20	2	000960675
1/4	236	106	16,90	2	000960676
5/16	255	117	19,10	2	000960678
3/8	285	132	22,50	2	000960680



96T/AS8	124,00	1	000960682
3/32-7/64-1/8-5/32-3/16-1/4-5/16-3/8			
96T/AS10	153,00	1	000960683
3/32-7/64-1/8-9/64-5/32-3/16-7/32-1/4-5/16-3/8			



## 96TBP

chaves macho hexagonal com punho e extremidade esférica



mm	L mm	L1 mm	€	U	PC
2,5	153	55	10,70	3	000960685
3	153	55	11,40	3	000960686
4	179	70	11,90	3	000960687
5	200	84	12,50	3	000960688
6	221	103	13,60	3	000960689
8	255	117	18,00	2	000960690
10	285	132	19,20	2	000960692



96TBP/S6	78,00	1	000960694
2,5-3-4-5-6-8 mm			

## 97TX

chaves macho para parafusos com cabeça Torx®



mm	L mm	L1 mm	€	U	PC
T6	42	16	5,85	5	000970006
T7	48	16	5,85	5	000970007
T8	48	16	5,85	5	000970008
T9	48	16	6,35	5	000970009
T10	51	17	6,50	5	000970010
T15	54	18	6,50	5	000970015
T20	57	19	6,90	5	000970020
T25	60	20	7,10	5	000970025
T27	64	21	7,75	5	000970027
T30	70	24	7,75	5	000970030
T40	76	26	8,65	5	000970040
T45	83	29	10,30	5	000970045
T50	95	32	11,70	5	000970050
T55	108	35	15,10	5	000970055
T60	120	38	20,00	5	000970060



97TX/ST8	63,00	1	000970640
T9-T10-T15-T20-T25-T27-T30-T40			



<b>97TX/G8</b>	€ 49,00	1	000970645
T9-T10-T15-T20-T25			
T27-T30-T40			



<b>97TX/BG8</b>	€ 38,50	1	000970368
T9-T10-T15-T20-T25-T27-T30-T40			



<b>97TX/SC8</b>	€ 61,50	1	000970064
T9-T10-T15-T20-T25			
T27-T30-T40			
<b>97TX/SCV</b>	€ 3,85	1	000970985



<b>97TX/B13</b>	€ 98,50	1	000970650
T6-T7-T8-T9-T10-T15-T20			
T25-T27-T30-T40-T45-T50			
<b>96N/BV</b>	€ 1,65	1	000960651

### 97BTX

chaves macho com uma extremidade esférica, para parafusos com cabeça Torx®

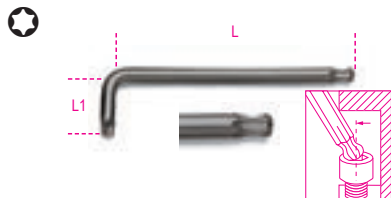

⊕	L mm	L1 mm	€	📦	📄
T9	80	16	7,35	5	000970109
T10	86	17	7,35	5	000970110
T15	90	18	7,35	5	000970115
T20	95	19	7,85	5	000970120
T25	100	20	8,40	5	000970125
T27	105	21	8,85	5	000970127
T30	114	24	8,95	5	000970130
T40	124	26	10,20	5	000970140
T45	133	28	12,10	5	000970145
T50	152	32	13,50	3	000970150
T55	164	35	19,50	3	000970155



<b>97BTX/SC8</b>	€ 70,00	1	000970164
T9-T10-T15-T20-T25-T27-T30-T40			
<b>97BTX/SCV</b>	€ 3,85	1	000970983



<b>97BTX/B8</b>	€ 68,00	1	000970159
T9-T10-T15-T20-T25			
T27-T30-T40			
<b>96N/BV</b>	€ 1,65	1	000960651

### 97BTXL

chaves macho com uma extremidade esférica, para parafusos com cabeça Torx®, modelo longo



	L mm	L1 mm	€	📦	📄
T9	80	15	7,65	3	000970309
T10	86	17	7,65	3	000970310
T15	100	18	7,65	3	000970315
T20	110	19	8,75	3	000970320
T25	126	20	9,60	3	000970325
T27	140	24	10,70	3	000970327
T30	160	28	11,30	3	000970330
T40	176	32	13,30	3	000970340



<b>97BTXL/SC8</b>	€ 80,50	1	000970364
T9-T10-T15-T20-T25-T27-T30-T40			
<b>97BTXL/SCV</b>	€ 3,85	1	000970982

### 97RTX

chaves macho para parafusos com cabeça Tamper Resistant Torx®



⊕	L mm	L1 mm	€	📦	📄
T9	56	16	6,85	5	000970209
T10	62	17	7,00	5	000970210
T15	72	17	7,00	5	000970215
T20	83	18	7,20	5	000970220
T25	90	18	7,45	5	000970225
T27	100	20	8,35	5	000970227
T30	105	24	8,40	5	000970230
T40	112	26	9,30	5	000970240



<b>97RTX/SC8</b>	€ 65,50	1	000970263
T9-T10-T15-T20-T25			
T27-T30-T40			
<b>97RTX/SCV</b>	€ 3,85	1	000970984



<b>97RTX/B8</b>	€ 63,50	1	000970260
T9-T10-T15-T20-T25			
T27-T30-T40			
<b>96N/BV</b>	€ 1,65	1	000960651

### 97TTX

chaves duplas macho com punho para parafusos com cabeça Torx®

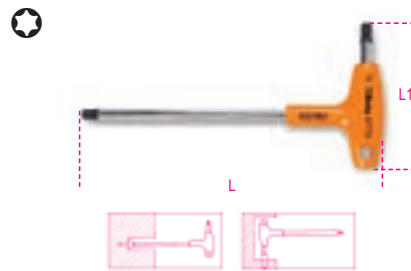

⊕	L mm	L1 mm	€	📦	📄
T6	130	52	10,50	3	000970706
T7	130	52	10,50	3	000970707
T8	139	52	10,50	3	000970708
T9	139	52	10,50	3	000970709
T10	179	70	10,90	3	000970710
T15	179	70	11,80	3	000970715
T20	179	70	12,30	3	000970720
T25	179	70	12,90	3	000970725
T27	200	84	14,20	3	000970727
T30	200	84	14,80	3	000970730
T40	221	103	17,50	3	000970740
T45	236	106	20,30	2	000970745
T50	255	117	26,00	2	000970750



<b>97TTX/S6</b>	€ 80,50	1	000970791
T10-T15-T20-T25-T30-T40			
<b>97TTX/S8</b>	€ 105,00	1	000970808
T8-T10-T15-T20-T25-T27-T30-T40			
<b>97TTX/S11</b>	€ 162,00	1	000970800
T8-T9-T10-T15-T20-T25-T27-T30-T40-T45-T50			
<b>97TTX/S13</b>	€ 183,00	1	000970813
T6-T7-T8-T9-T10-T15-T20-T25-T27-T30-T40-T45-T50			



<b>97TTX/SP11</b>	€ 174,00	1	000970840
T8-T9-T10-T15-T20-T25			
T27-T30-T40-T45-T50			
<b>96T/SPV</b>	€ 14,80	1	000960958
96T/S11			
97TTX/S11			

## 98XZN

chaves macho hexagonal com perfil XZN®

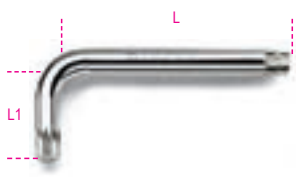

DIN 65253

Ø	L mm	L1 mm	€	U	IT
<b>M5</b>	83	25	5,05	5	000980005
<b>M6</b>	89	30	5,80	5	000980006
<b>M8</b>	97	32	7,35	5	000980008
<b>M10</b>	106	35	9,60	5	000980010
<b>M12</b>	116	37	12,10	5	000980012
<b>M14</b>	118	45	15,40	5	000980014
<b>M16</b>	125	45	22,90	5	000980016



<b>98XZN/B5</b>	€ 41,50	1	000980650
M5-M6-M8-M10-M12			
<b>96N/BV</b>	€ 1,65	1	000960651

## 99

chaves de unha quadrada para porcas com encaixes laterais UNI/ISO 2982, 2983



UNI 6752

Ø mm	A mm	€	U	IT
<b>12-14</b>	1,5	9,50	3	000990012
<b>16-18-20</b>	1,8	9,50	3	000990016
<b>22-25-28</b>	1,8	12,60	3	000990022
<b>30-32</b>	2,1	12,60	3	000990030
<b>34-36-38</b>	2,4	15,40	3	000990034
<b>40-42</b>	2,4	15,40	3	000990040
<b>45-50</b>	2,5	19,00	3	000990045
<b>52-55-58</b>	2,5	19,00	3	000990052
<b>62-65</b>	3,1	24,00	3	000990062
<b>68-70-75</b>	3,1	24,00	3	000990068
<b>80-85-90</b>	3,8	32,00	2	000990080
<b>92-95</b>	4,3	32,00	2	000990092
<b>98-100</b>	4,3	32,00	2	000990098
<b>105-110-115</b>	4,4	51,50	1	000990105
<b>120-125-130</b>	4,9	51,50	1	000990120
<b>135-145</b>	6,0	76,50	1	000990135
<b>155-165</b>	6,0	76,50	1	000990155

## 99SQ

chaves de unha quadrada articulada para porcas com encaixes laterais



Ø mm	B mm	€	U	IT
<b>15-35</b>	2,7	26,00	2	000990215
<b>35-50</b>	3,5	29,50	2	000990235
<b>50-80</b>	4,7	38,50	2	000990250
<b>80-120</b>	6,2	52,50	2	000990280
<b>120-180</b>	7,8	70,00	2	000990290

## 99ST

chaves de unha articulada com pino redondo amovível



Ø mm	Ø mm	B mm	€	U	IT
<b>15-35</b>	3,0	2,5	26,50	2	000990315
<b>35-50</b>	4,0	4,5	32,00	2	000990335
<b>50-80</b>	5,0	5,0	41,50	2	000990350
<b>80-120</b>	6,0	7,0	56,50	2	000990380
<b>120-180</b>	8,0	9,0	73,50	2	000990390

## 99 VN/...

ponta de substituição para artigo 99ST

Ø mm	mm	€	U	IT
<b>99ST VN/15</b>	15-35	7,35	1	000990295
<b>99ST VN/35</b>	35-50	8,40	1	000990296
<b>99ST VN/50</b>	50-80	10,20	1	000990297
<b>99ST VN/80</b>	80-120	11,80	1	000990298
<b>99ST VN/120</b>	120-180	15,20	1	000990299

## 100

chaves de compasso com unhas redondas para porcas com furos de manobra frontais



Ø mm	L mm	Ø min-max mm	€	U	IT
<b>4,9-5,9</b>	250	18÷100	135,00	1	001000001
<b>6,9-7,9</b>					

## 100/KIT

unhas de substituição para refª. 100

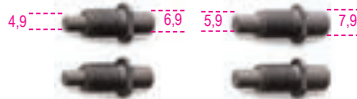

<b>100/KIT</b>	€ 43,00	1	001000010
----------------	---------	---	-----------

## 111

chaves ajustáveis com escala, cromadas

- Rotação direita do pino
- Com escala em mm e polegadas



DIN 3117 ISO 6787

L mm	L"	A max mm	€	U	IT
<b>100</b>	4	15	21,30	3	001110010
<b>150</b>	6	24	22,40	3	001110015
<b>200</b>	8	28	27,00	3	001110020
<b>250</b>	10	34	33,50	3	001110025
<b>300</b>	12	35	44,00	3	001110030
<b>380</b>	15	45	86,50	3	001110038
<b>450</b>	18	54	143,00	2	001110045
<b>600</b>	24	62	196,00	1	001110060

## 111N

chaves ajustáveis com escala, fosfatadas

- Rotação direita do pino
- Com escala em mm e polegadas



DIN 3117 ISO 6787

L mm	L"	A max mm	€	U	IT
<b>100</b>	4	15	19,70	3	001110210
<b>150</b>	6	24	20,80	3	001110215
<b>200</b>	8	28	24,00	3	001110220
<b>250</b>	10	34	30,00	3	001110225
<b>300</b>	12	35	41,00	3	001110230
<b>380</b>	15	45	78,50	3	001110238
<b>450</b>	18	54	135,00	2	001110245

## 111G

chaves ajustáveis com escalas cromadas, punhos de 2 componentes

- Rotação do pino à direita
- Escala em mm e polegadas
- Punho ergonómico



DIN 3117 ISO 6787

L mm	L"	A max mm	€	U	IT
<b>200</b>	8	28	32,50	3	001110620
<b>250</b>	10	34	40,00	3	001110625
<b>300</b>	12	35	51,50	2	001110630



## 120

chaves de luneta aberta de 12 faces com sistema de roquete simples



mm	L mm	€		
10	135	44,00	1	001200010
11	135	44,00	1	001200011
12	135	44,00	1	001200012
13	135	44,00	1	001200013
14	135	50,00	1	001200014
17	185	52,00	1	001200017
19	185	55,50	1	001200019
22	230	77,00	1	001200022
24	230	82,50	1	001200024
27	230	105,50	1	001200027
30	320	120,00	1	001200030
32	320	126,00	1	001200032



	€		
120/B6 10-11-13 17-19-22 mm	323,00	1	001200050
120/BV	8,75	1	001200051

## 123E1/4

adaptador, 1/4", para chaves de roquete de 10 mm

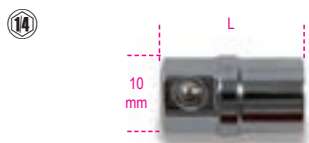

mm	L mm	€		
10	20,6	5,80	1	001230010

## 123Q1/4

adaptador de desengate rápido, 1/4", para chaves de roquete, 10mm

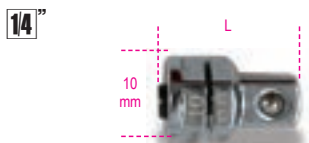

mm	L mm	€		
10	17,5	7,85	1	001230310

## 123Q3/8

adaptador de desengate rápido, 3/8", para chaves de roquete, 13mm



mm	L mm	€		
13	22,5	7,85	1	001230313

## 123Q1/2

adaptador de desengate rápido, 1/2", para chaves de roquete, 19mm

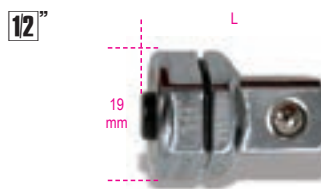

mm	L mm	€		
19	30,5	8,55	1	001230319

## 123/K4

kit com 4 adaptadores para chaves de roquete:

- 1 ponta adaptadora
- 3 adaptadores de desengate rápido



	€		
123/K4	30,00	1	001230504

## 142

chaves boca/luneta com sistema de roquete



mm	L mm	€		
6x6	136	15,70	3	001420006
7x7	136	15,70	3	001420007
8x8	136	16,30	3	001420008
9x9	143	17,30	3	001420009
10x10	159	17,90	3	001420010
11x11	168	18,40	3	001420011
12x12	174	18,90	3	001420012
13x13	180	20,40	3	001420013
14x14	190	21,10	2	001420014
15x15	200	22,40	2	001420015
16x16	216	24,00	2	001420016
17x17	233	24,60	2	001420017
18x18	239	26,50	2	001420018
19x19	248	27,00	2	001420019
21x21	285	35,50	1	001420021
22x22	285	37,00	1	001420022
24x24	325	43,00	1	001420024
27x27	355	62,00	1	001420027
30x30	420	72,50	1	001420030
32x32	420	75,00	1	001420032
* 36x36	480	104,50	1	001420036



	€		
142/B6 8-10-13-14-17-19 mm	136,00	1	001420066
142/BV6	8,20	1	001420076
142/B9 8-10-11-12-13-14-15-17-19 mm	197,00	1	001420069
142/BV9	9,85	1	001420079



	€		
142/S15 6-7-8-9-10-11-12-13 14-15-16-17-18-19-22 mm	322,00	1	001420074
142/S17 6-7-8-10-11-12-13-14-15- 16-17-18-19-21-22-24-27 mm	444,00	1	001420068
142/S19 6-7-8-9-10-11-12 13-14-15-16-17-18 19-22-24-27-30-32 mm	574,00	1	001420075

## 142/SC9I-E

jogo de 9 chaves mistas boca luneta, com sistema de roquete, suporte compacto



	€		
142/SC9I 8-10-11-12-13-14-15-17-19 mm	195,00	1	001420087
142/SCV9I	9,30	1	001420103
142/SC9E 8-10-11-12-13-16-17-18-19 mm	202,00	1	001420088
142/SCV9E	9,30	1	001420104

## 142AS

chaves boca/luneta com sistema de roquete



	L mm	€		
5/16x5/16	136	19,10	2	001420308
3/8x3/8	159	19,70	2	001420310
7/16x7/16	168	20,80	2	001420311
1/2x1/2	180	23,20	2	001420313
9/16x9/16	190	23,70	2	001420314
5/8x5/8	216	26,00	2	001420316
11/16x11/16	233	26,50	2	001420317
3/4x3/4	248	29,50	2	001420319



<b>142AS /8</b>	€ 188,00	1	001420330
5/16-3/8-7/16-1/2			
9/16-5/8-11/16-3/4			

## 142C

chaves boca/luneta, série curta



mm	L mm	€		
8x8	88	11,60	2	001420108
9x9	96	11,60	2	001420109
10x10	96	12,00	2	001420110
11x11	100	12,80	2	001420111
12x12	104	13,70	2	001420112
13x13	108	14,40	2	001420113
14x14	114	15,10	2	001420114
15x15	118	15,60	2	001420115
16x16	122	16,20	2	001420116
17x17	128	17,50	2	001420117
18x18	132	18,70	2	001420118
19x19	138	19,10	2	001420119



<b>142C/A12</b>	€ 202,00	1	001420175
8-9-10-11-12-13-14			
15-16-17-18-19 mm			

## 142SN

chaves boca/luneta articulada com sistema de roquete



mm	L mm	€		
7x7	136	18,80	2	001420207
8x8	136	19,70	2	001420208
9x9	143	20,20	2	001420209
10x10	160	21,80	2	001420210
11x11	168	22,40	2	001420211
12x12	174	22,90	2	001420212
13x13	180	24,60	2	001420213
14x14	193	25,50	2	001420214
15x15	200	27,00	2	001420215
16x16	216	29,00	2	001420216
17x17	233	29,50	2	001420217
18x18	239	32,00	2	001420218
19x19	250	32,50	2	001420219
22x22	285	37,50	1	001420222
24x24	325	42,00	1	001420224

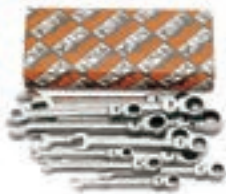

<b>142SN/S13</b>	€ 324,00	1	001420263
7-8-9-10-11-12-13-14			
15-16-17-18-19 mm			

## 186

chave auto-ajustável, 8 a 32 mm

Ideal para parafusos de cabeça sextavada, quadrada, Spline e Torx®, mesmo danificados.



L mm	€		
260	45,00	1	001860008

## 187

chave de luneta articulada



mm	L mm	€		
8x9	125	29,50	1	001870008
10x11	155	32,00	1	001870010
12x13	175	33,00	1	001870012
14x15	205	36,00	1	001870014
16x17	235	41,00	1	001870016



<b>187/B5</b>	€ 181,00	1	001870050
8x9-10x11-12x13			
14x15-16x17 mm			

## 188

chaves de luneta plana bi-sextavadas com roquete para polias livres de alternador



mm	L mm	€		
10	240	20,40	2	001880010
15	322	27,00	2	001880015

## 192

chaves bi-hexagonais com sistema de roquete reversível, cromadas, 4 in 1



mm	L mm	€		
8x10/12x13	160	26,00	1	001920008
16x17/18x19	230	33,50	1	001920016



<b>192/S2</b>	€ 59,50	1	001920070
8x10/12x13 mm			
16x17/18x19 mm			

## 194

chave de caixa com sistema de roquete reversível



mm	L mm	€		
1/4x5/16	128	34,00	2	001940006

## 195

chave de luneta dupla, bi-hexagonal, com sistema de roquete



mm	L mm	€		
8x10	128	18,10	2	001950010
12x13	170	21,00	2	001950013
14x15	190	22,10	2	001950015
16x18	230	25,50	2	001950018
17x19	230	26,00	2	001950019



<b>195/B5</b>	€ 123,00	1	001950066
8x10-12x13-14x15			
16x18-17x19 mm			
<b>195/BV5</b>	9,85	1	001950070

## 195AS

chave de luneta dupla cromada, bisextavada, com sistema de roquete



mm	L mm	€		
5/16x3/8	128	18,70	2	001950606
7/16x1/2	170	21,00	2	001950611
9/16x5/8	190	23,70	2	001950614
11/16x3/4	230	26,00	2	001950617



<b>195AS/B4</b>	€ 99,50	1	001950654
5/16x3/8 - 7/16x1/2 - 9/16x5/8 - 11/16x3/4			
<b>195FTX/BV4</b>	€ 9,85	1	001950520

## 195P

chave bi-hexagonal dupla inclinada a 15° e com sistema de roquete reversível



Ø mm	L mm	€		
8x10	128	27,50	2	001950210
12x13	170	29,50	2	001950213
14x15	190	31,00	2	001950215
16x18	230	34,00	2	001950218
17x19	230	36,00	2	001950219



<b>195P/B5</b>	€ 167,00	1	001950266
8x10-12x13-14x15 16x18-17x19 mm			
<b>195/BV5</b>	€ 9,85	1	001950070

## 310

ferro de soldar tubos e uniões de pequenas dimensões em plástico tipo PE, PP, PVC e PEHD

CE



230V-650 Watt 50 Hz±60Hz Schuko (CEE 7/7)

	Ø mm	€		
<b>310/1</b>	16÷50	238,00	1	003100001
<b>310/2</b>	16÷63	331,00	1	003100002

## 310B

matrizes para o polifusor modelo 310



Ø mm	€		
16	57,50	1	003100016
20	63,00	1	003100020
25	66,50	1	003100025
32	73,50	1	003100032
40	86,50	1	003100040
50	109,00	1	003100050
63	126,00	1	003100063

## 310/C4

jogo com polifusor e 3 matrizes



<b>310/C4</b>	€ 479,00	1	003100104
310/1+310B: Ø 20-25-32			
410x260x82 mm - 4,8 kg			

## 310/C8

jogo com polifusor e 7 matrizes



<b>310/C8</b>	€ 743,00	1	003100108
310/2+310B: Ø 16-20-25 32-40-50-63			
440x270x120 mm - 7,7 kg			

## 311

ferro de soldar tubos e uniões de grandes dimensões em plástico tipo PE, PP, PVC e PEHD

CE

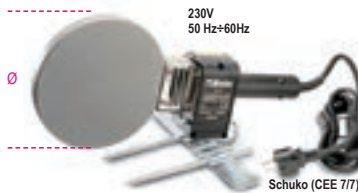

230V 50 Hz±60Hz Schuko (CEE 7/7)

	Ø mm	Watt	€		
<b>311/1</b>	120	300	289,00	1	003110001
<b>311/2</b>	190	900	329,00	1	003110002

## 330

corta-tubos para tubos de gás em aço



	Ø mm - "	L mm	€		
<b>330/2</b>	10÷60	380	139,00	1	003300002
<b>330/4</b>	1/8"÷2" 60÷115 2"÷4"	585	314,00	1	003300004

## 330R/A

cortante de substituição para o modelo 330 para tubos em aço

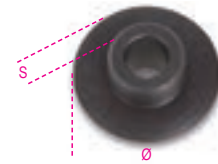

	Ø mm	S mm	€		
<b>330R/A2</b>	32	7	13,10	1	003300012
<b>330R/A4</b>	42	9	34,50	1	003300014

## 330R/I

cortante de substituição para o artigo 330 para tubos de aço inox



	Ø mm	S mm	€		
<b>330R/I2</b>	32	7	30,00	1	003300024
<b>330R/I4</b>	32	9	82,50	1	003300034

## 331L

corta-tubos com roquete para cobre e ligas leves



	Ø mm - "	L mm	€		
<b>8÷29</b>		180	63,00	1	003310008
<b>5/16"÷1"1/8</b>					

## 331LR/L

lâmina de substituição para corta-tubos 331L



	Ø mm	€		
<b>331LR/L</b>	18	6,00	1	003310058

## 332

mini corta-tubos para cobre e ligas leves



	Ø mm - "	L mm	€		
<b>3÷16</b>		59	19,70	2	003320001
<b>1/8"÷5/8"</b>					



### 334

corta-tubos para cobre e ligas leves



Ø mm - "	L mm	€	1	003340001
3÷30 1/8"÷1"1/8	150	27,00	1	003340001

### 334R

cortante de substituição para os modelos com refª. 332 e 334 para cobre e ligas leves

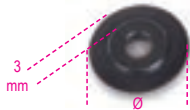

Ø mm	€	1	003340021
334R 18	5,45	1	003340021

### 334R/I

cortante de substituição para os modelos com refª. 332 e 334 para aço inox

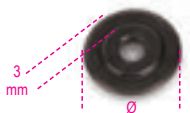

Ø mm	€	1	003340023
334R/I 18	16,20	1	003340023

### 336

corta-tubos com avanço telescópico para cobre e ligas leves



Ø mm - "	L mm	€	1	003360001
6÷38 1/4"÷1"1/2	160	46,00	1	003360001

### 338

corta-tubos com avanço telescópico rápido para cobre, ligas leves e plásticos



Ø mm - "	L mm	€	1	003380001
6÷67 1/4"÷2"5/8	290	114,00	1	003380001

### 338R

cortante de substituição para os modelos 336 e 338 para cobre e ligas leves



Ø mm	€	1	003380022
338R 18,5	6,00	1	003380022

### 338R/I

cortante de substituição para os modelos 336 e 338 para aço inox



Ø mm	€	1	003380023
338R/I 21,8	18,10	1	003380023

### 338RP

cortante de substituição para os modelos 336 e 338 para plástico



Ø mm	€	1	003380025
338RP 21,9	6,55	1	003380025

### 339A

corta-tubos com avanço telescópico rápido para tubos de plástico



Ø mm - "	L mm	€	1	003390011
50÷127 2"÷5"	345	241,00	1	003390011

### 339A/R

cortante de substituição para o modelo 339A



Ø mm	€	1	003390061
339A/R 42	16,40	1	003390061

### 340

alicate para corte de tubos multi-camadas max. Ø 26 mm

- Lâmina com revestimento PTFE
- 4 rolos de suporte para facilitar a rotação do tubo durante o trabalho
- Punho com sistema integrado para corte de tubos ondulados
- Corpo leve em magnésio
- Ø máx.: 26 mm



Ø max mm	€	1	003400001
340 26	94,00	1	003400001

### 340RL

Lamina de substituição para o item 340



€	1	003400010
340RL 26,00	1	003400010

### 341

alicate corta-tubos para tubos plásticos



Ø mm	L mm	€	1	003410001
341 0÷25	190	33,00	1	003410001

### 341RL

lâmina de substituição para o modelo 341



€	1	003410010
341RL 13,80	1	003410010



### 341B

tesoura com roquete para tubos de plástico



Ø	L	€		
mm - "	mm			
0÷35	195	62,00	1	003410051

### 341B/RM

mola de substituição para o artigo 341B

341B/RM	€			
	2,30	1	003410061	

### 341B/RL

lâminas de substituição para o artigo 341B



341B/RL	€			
	21,80	1	003410060	

### 342

Tesoura com roquete para tubos de plástico



Ø	L	€		
mm - "	mm			
0÷42	200	45,50	1	003420030
1"5/8				

### 342MOL

mola de substituição para o artigo 342

342MOL	€			
	3,30	1	003420033	

### 342RL

lâmina de substituição para o artigo 342



342RL	€			
	20,20	1	003420032	

### 342A

tesoura com roquete para tubos plásticos



Ø	L	€		
mm - "	mm			
0÷50	270	90,50	1	003420101
2"				

### 342A/MOL

mola de substituição para artigo 342A

342A/MOL	€			
	2,00	1	003420111	

### 342A/RL

lâmina de substituição para o modelo 342A



342A/RL	€			
	47,50	1	003420110	

### 342P

tesoura com roquete para tubos plásticos, corpo em liga de magnésio



Ø	L	€		
mm - "	mm			
0÷50	260	100,50	1	003420121
2"				

### 342P/RL

lâmina de substituição para ref. 342P



342P/RL	€			
	41,50	1	003420130	

### 345

ferramenta rebarba-tubos corpo em metal

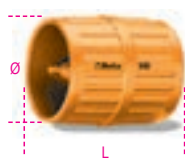

Ø	L	€		
mm - "	mm			
3÷42	58	25,50	5	003450001
1/8"÷1"5/8				

### 345U

ferramenta rebarba-tubos para aço inoxidável, aço, cobre e ligas leves



Ø	L	€		
mm - "	mm			
4÷36	60	65,50	1	003450050
5/32÷1"7/16				

### 345C

manómetro para tubos com várias camadas



Ø	€			
mm				
16-20-26-32	40,00	1	003450032	

### 345SB

rebarbador de lâmina giratório com lâmina intermutável



L	€			
mm				
150	20,40	5	003450010	

### 345SB/R

lâmina de substituição para o modelo 345SB



345SB/R	€			
	7,10	3	003450015	

### 349

abocardador com embraiagem para tubos em cobre e ligas leves



Ø	€			
mm - "				
6-8-10-12-14-15-16-18	242,00	1	003490001	
(1/8-3/16-1/4-5/16				
3/8-1/2-5/8-3/4)				
270x200x50 mm - 2,7 kg				

### 349/SMM

fixador de tubos métrico para artigo 349



∅ mm	€	U	Artigo
6-8-10-12-14-15-16-18	72,50	1	003490011

### 349/SMAS

fixador de tubos em polegadas para artigo 349



∅ "	€	U	Artigo
1/8-3/16-1/4-5/16 3/8-1/2-5/8-3/4	68,50	1	003490012

### 350

abocardador, para tubos em cobre e ligas leves



∅ mm	L mm	A mm	€	U	Artigo
4-4,75-6-8 10-12-14	175	104	72,50	1	003500001

### 351C

corta-tubos e abocardador



351C	€	U	Artigo
	130,00	1	003510010

334	∅ 3÷30 mm (1/8"÷1"1/8)
350	∅ 4÷14 mm
351P	∅ 4-4,75-6-8-10-12-14 mm

225x150x45 mm - 1,6 kg

### 351P

punções para abocardador refª. 350



	∅ mm	€	U	Artigo
351P 4	4	5,90	3	003510101
351P 4,75	4,75	5,90	3	003510102
351P 6	6	5,90	3	003510103
351P 8	8	5,90	3	003510104
351P 10	10	5,90	3	003510105
351P 12	12	5,90	3	003510106
351P 14	14	5,90	3	003510107

### 352U

abocardador regulável para cobre e ligas leves

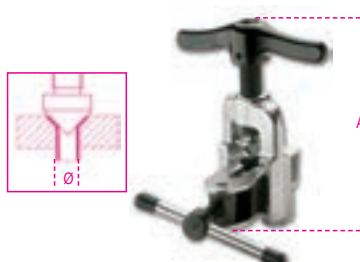

∅ mm - "	A mm	€	U	Artigo
5÷16 3/16÷5/8	130	84,50	1	003520101

### 352C/U

jogo corta-tubos, rebarbador e abocardador, artigos 334, 345SB e 352U



352C/U	€	U	Artigo
	163,00	1	003520110

334 ∅ 3÷30 mm (1/8"÷1"1/8)

345SB

352U ∅ 5÷16 mm (3/16"÷5/8")

335x145x60 mm - 2120 g

### 353N

alicate alargador com matriz de expansão intermutável



L mm	€	U	Artigo
380	327,00	1	003530201

### 353NM

matrizes de expansão para alicate alargador modelo 353N

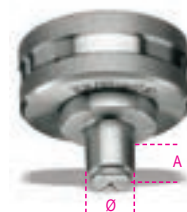

∅ mm	A mm	€	U	Artigo
10	7	111,00	1	003530210
12	10	111,00	1	003530212
14	10	111,00	1	003530214
16	12	111,00	1	003530216
18	12	111,00	1	003530218
22	13	111,00	1	003530222

### 353N/C6

alicate alargador modelo 353N com matrizes de expansão modelo 353NM



353N/C6	€	U	Artigo
	1.025,00	1	003530300

353N

353NM ∅ 10-12-14-16-18-22 mm

420x185x60 mm - 2,2 kg

### 355

chave de 5 graduações para radiadores



∅ "	L mm	€	U	Artigo
3/8" - 1/2" 3/4" - 1"	90	34,50	2	003550001

### 357F3

nível com 3 bolhas



∅ "	L mm	€	U	Artigo
3/8" / 1/2"	90÷220	108,00	1	003570100

### 357R/F3

bolha de substituição para nível 357F3



357R/F3	€	1	003570101
	16,90		

### 358

aparelhos para chanfrar externamente tubos plásticos



358/1	Ø mm	€	1	003580001
	16÷110	150,00		
358/2	40÷250	150,00	1	003580002

### 358RL

lâmina de substituição com batente para os modelos 358/1 e 358/2



358RL	€	1	003580011
	27,50		

### 359

chave universal para bujões



Ø"	L mm	A mm	€	1	003590001
1"÷1"1/4	160	140	73,50		

### 359CH

adaptador para bujões em cruz para o modelo 359



Ø"	L mm	€	1	003590005
1"1/2	74	41,50		

### 360

chaves para tubos modelo Stillson



L mm	Ø max"	Ø max mm	€	1	003600025
250	1" gas	34	32,50		
350	1"1/2 gas	49	43,00	1	003600035
450	2" gas	60	59,00	1	003600045
600	2"1/2 gas	76	89,50	1	003600060
900	3"1/2 gas	102	250,00	1	003600090

### 360R/...

kit peças de substituição para ref. 360 com mordente móvel e porca.

360R250	€	1	003600225
	12,00		
360R350	€	1	003600235
	15,90		
360R450	€	1	003600245
	23,50		
360R600	€	1	003600260
	35,50		
360R900	€	1	003600290
	61,50		

### 362

chaves para tubos modelo americano



L mm	Ø max"	Ø max mm	€	1	003620020
200	1" gas	34	28,00		
250	1"1/2 gas	49	35,00	1	003620025
300	2" gas	60	41,50	1	003620030
350	2" gas	60	50,50	1	003620035
450	2"1/2 gas	76	72,50	1	003620045
600	3" gas	90	110,00	1	003620060
900	5" gas	140	136,00	1	003620090

### 362R/...

kit peças de substituição para ref. 362 com: mordente fixa, mordente móvel; porca; pino de segurança.

362R 200	€	1	003620220
	5,70		
362R 250	€	1	003620225
	8,30		
362R 300	€	1	003620230
	9,85		
362R 350	€	1	003620235
	11,50		
362R 450	€	1	003620245
	15,50		
362R 600	€	1	003620260
	21,30		
362R 900	€	1	003620290
	53,00		

### 363

chaves para tubos modelo americano em ligas leves



L mm	Ø max"	Ø max mm	€	1	003630035
350	2" gas	60	61,50		
450	2"1/2 gas	76	81,50	1	003630045
600	3" gas	90	138,00	1	003630060
900	5" gas	140	259,00	1	003630090
1200	6" gas	165	271,00	1	003630120

### 363R/...

kit peças de substituição para ref. 363 com: mordente fixa, mordente móvel; porca; pino de segurança.

363R 350	€	1	003630235
	12,70		
363R 450	€	1	003630245
	17,10		
363R 600	€	1	003630260
	22,90		
363R 900	€	1	003630290
	49,00		
363R 1200	€	1	003630320
	73,50		

### 365

chaves para tubos modelo frontal em ligas leves



L mm	Ø max"	Ø max mm	€	1	003650035
350	2" gas	60	76,50		
450	2"1/2 gas	76	105,00	1	003650045

### 365R/...

kit peças de substituição para ref. 365 com: mordente fixa, mordente móvel; porca; pino de segurança.

365R 350	€	1	003650235
	57,50		
365R 450	€	1	003650245
	85,50		

### 366

chaves para tubos modelo ligeiro



L mm	Ø max"	Ø max mm	€	1	003660017
175	1" gas	34	28,00		
225	1"1/2 gas	49	34,00	1	003660022
275	2" gas	60	40,00	1	003660027
300	2"1/2 gas	76	44,00	1	003660030
350	3" gas	90	50,00	1	003660035

### 374

chaves para tubos modelo Sueco mordentes a 45°



DIN 5234

L mm	Ø max * gas	Ø max mm	€	🔧	📄
240	1/2" gas	21	34,00	1	003740024
320	1" gas	34	44,50	1	003740032
410	1 1/2" gas	49	58,50	1	003740041
550	2" gas	60	92,50	1	003740055
630	3" gas	90	164,00	1	003740063

### 375

chave para tubos modelo Sueco com mordentes a 45°



DIN 5234

L mm	Ø max * gas	Ø max mm	€	🔧	📄
320	1" gas	34	45,00	1	003750032
410	1 1/2" gas	49	58,50	1	003750041
550	2" gas	60	92,50	1	003750055

### 376

chaves para tubos modelo Sueco mordentes planos a 90°



DIN 5234

L mm	Ø max * gas	Ø max mm	€	🔧	📄
320	1" gas	34	45,00	1	003760032
410	1 1/2" gas	49	58,50	1	003760041
550	2" gas	60	92,50	1	003760055
630	3" gas	90	166,00	1	003760063

### 378

chaves para tubos modelo Sueco mordentes a 45°



DIN 5234

L mm	Ø max * gas	Ø max mm	€	🔧	📄
250	1/2" gas	21	35,50	1	003780025
320	1" gas	34	47,00	1	003780032
410	1 1/2" gas	49	61,50	1	003780041
550	2" gas	60	99,50	1	003780055
650	3" gas	90	169,00	1	003780065

### 374R/...

kit completo peças de substituição para refs. 374 - 375 - 376 - 378 com porca e batente

Ref.	€	🔧	📄
374R 240 x 374/240-378/250	2,00	1	003740724
374R 320 x 374/320-376/320-378/320	2,20	1	003740732
374R 410 x 374/410-375/410-376/410-378/410	2,40	1	003740741
374R 550 x 374/550-376/550-378/550	3,30	1	003740755
374R 630 x 374/630-378/650	4,60	1	003740763

### 383

chaves para tubos de correia



Ref.	Ø max * gas	Ø max mm	L mm	€	🔧	📄
383/1	3" gas	90	300	48,00	1	003830001
383/2	8" gas	220	300	50,50	1	003830002

### 383R

correia de substituição para o modelo 383



Ref.	S mm	€	🔧	📄
383R/1	27	18,80	1	003830010
383R/2	27	20,80	1	003830015

### 384

chave de corrente para tubos reversível



Ref.	Ø max * gas	Ø max mm	L mm	€	🔧	📄
384	4" gas	115	300	64,00	1	003840032

### 384RC

corrente de substituição para o modelo 384



Ref.	€	🔧	📄
384RC	40,00	1	003840033

### 386A

chaves de corrente reversíveis, para trabalhos pesados



Ref.	Ø max gas	L mm	€	🔧	📄
386A/3	4" gas 115 mm	900	213,00	1	003860003
386A/4	6" gas 168 mm	900	409,00	1	003860004
386A/5	8" gas 220 mm	1100	517,00	1	003860005
386A/6	12" gas 324 mm	1300	896,00	1	003860006

### 386A/RC

correntes de substituição para o modelo 386A



Ref.	€	🔧	📄
386A3/RC	68,50	1	003860013
386A4/RC	98,00	1	003860014
386A5/RC	130,00	1	003860015
386A6/RC	226,00	1	003860016

### 388

curva tubos para tubos de baixa espessura em cobre, ligas leves ou aço macio

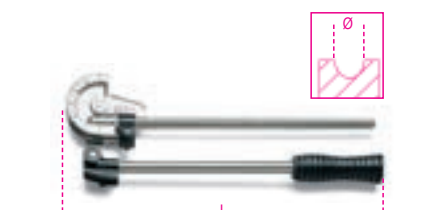

Ø mm	L mm	€	🔧	📄
6	305	52,50	1	003880006
8	315	57,00	1	003880008
10	350	65,50	1	003880010
12	360	70,00	1	003880012
14	455	90,50	1	003880014
15	465	96,00	1	003880015
16	465	104,00	1	003880016

### 388A

alicate curva-tubos para tubos de baixa espessura em cobre e ligas leves



Ref.	Ø mm	L mm	€	🔧	📄
388A/1	6-8-10 mm	220	57,50	1	003880051
388A/2	1/4"-5/16"-3/8"	220	57,50	1	003880055

### 388C/C8

curvadora de tubos com 7 matrizes, para tubos finos de cobre e liga leve



388C/C8	∅ mm	€	1	003880200
	10-12-14-16-18-20-22	418,00		

400x330x110 mm - 3,6 kg

### 392C

alicate ajustável para sifões



392C	∅ mm	L mm	€	1	003920100
	25÷65	260	40,00		

### 392RG/C

par de protectores de substituição para ref. 392C



392RG/C	€	1	003920101
	5,45		

### 393

alicate para porcas de torneira



393	L mm	€	1	003930001
	270	58,00		

### 395

chave articulada para porcas de lavatórios

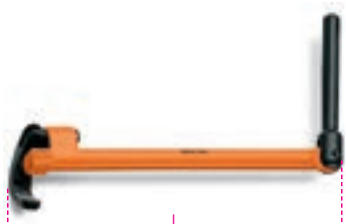

395	∅ mm	L mm	€	1	003950001
	15÷32 mm	240	38,00		

5/8"±1"1/4

### 395T

chave articulada telescópica para porcas de lavatórios



395T	∅ mm	L mm	€	1	003950100
	10÷32 mm	250÷430	51,50		

### 399

torno de bancada

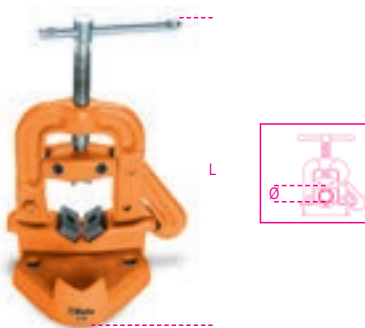

399	∅ mm	L min mm	€	1	003990005
	10÷60 mm	220	159,00		
	1/8÷2"				
	10÷89 mm	290	286,00		
	1/8÷3"				

### 410

brocas cilíndricas série curta HSS

R ≤ 650 N/mm<sup>2</sup>  
HV ~ 750÷820



DIN 338 ISO 235

410	∅ mm	L mm	L1 mm	€	10	004100030
	0,50	22	6	1,45		
	1,00	34	12	0,80		
	1,25	38	16	0,70		
	1,50	40	18	0,60		
	1,75	46	22	0,60		
	2,00	49	24	0,55		
	2,25	53	27	0,70		
	2,50	57	30	0,60		
	2,75	61	33	0,70		
	3,00	61	33	0,60		
	3,20	65	36	0,80		
	3,25	65	36	0,80		
	3,50	70	39	0,80		
	3,75	70	39	0,90		
	4,00	75	43	0,85		
	4,20	75	43	1,05		
	4,25	75	43	1,05		
	4,50	80	47	0,95		
	4,75	80	47	1,10		
	5,00	86	52	1,00		
	5,25	86	52	1,50		
	5,50	93	57	1,40		
	5,75	93	57	1,55		
	6,00	93	57	1,40		
	6,25	101	63	1,80		
	6,50	101	63	1,70		
	6,75	109	69	2,15		
	7,00	109	69	2,00		
	7,50	109	69	2,10		

∅ mm	L mm	L1 mm	€	10	004100124
8,00	117	75	2,40		
8,50	117	75	2,55		
9,00	125	81	3,20		
9,50	125	81	3,40		
10,00	133	87	3,70		
10,50	133	87	4,55		
11,00	142	94	5,25		
11,50	142	94	5,55		
12,00	151	101	6,25		
12,50	151	101	6,60		
13,00	151	101	7,00		
14,00	160	108	9,35		
15,00	169	114	10,90		
16,00	178	120	13,60		
17,00	186	125	14,90		
18,00	194	130	18,00		
19,00	202	135	20,20		
20,00	210	140	23,80		



410/SP19	∅	€	1	004100419
	1÷10 x 0,5 mm	40,00		
410/SPV1	∅	€	1	004100420
	1÷13 x 0,5 mm	21,30		
410/SP25	∅	€	1	004100425
	1÷13 x 0,5 mm	83,50		
410/SPV2	∅	€	1	004100426
	1÷13 x 0,5 mm	31,00		



410/SEL19	∅	€	1	004100418
	1÷10 x 0,5 mm	31,00		

### 410MIX/SEL19

jogo de 13 brocas 410 e 6 com inserção de metal duro



410MIX/SEL19	€	1	004100417
	31,50		

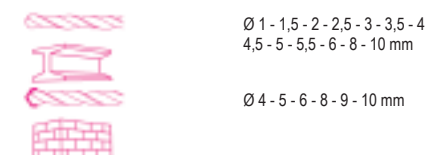

## 410A

brocas cilíndricas série curta HSS

R ≤ 650 N/mm<sup>2</sup>  
HV ~ 750÷820



Ø mm	L mm	L1 mm	€	U	U
13,50	160	108	11,30	5	004100281
14,00	160	108	11,30	5	004100283
14,50	169	114	12,90	5	004100285
15,00	169	114	12,90	5	004100287
15,50	178	120	15,90	5	004100289
16,00	178	120	15,90	5	004100291
16,50	186	125	16,90	3	004100292
17,00	186	125	16,90	3	004100293
17,50	194	130	20,20	3	004100294
18,00	194	130	20,20	3	004100295
18,50	202	135	22,20	3	004100296
19,00	202	135	22,20	3	004100297
19,50	210	140	26,00	3	004100298
20,00	210	140	26,00	3	004100299

## 410AS

brocas cilíndricas série curta HSS

R ≤ 650 N/mm<sup>2</sup>  
HV ~ 750÷820



ANSI B94

Ø "	L mm	L1 mm	€	U	U
1/16	48	22	0,55	10	004100371
5/64	51	25	0,60	10	004100372
3/32	57	32	0,70	10	004100373
7/64	67	38	0,70	10	004100374
1/8	70	41	0,85	10	004100375
9/64	73	44	0,90	10	004100376
5/32	79	51	0,95	10	004100377
11/64	83	54	1,10	10	004100378
3/16	89	59	1,20	10	004100379
13/64	92	62	1,30	10	004100380
7/32	95	64	1,40	10	004100381
15/64	98	67	1,60	10	004100382
1/4	102	70	1,75	10	004100383
17/64	105	73	2,15	10	004100384
9/32	108	75	2,35	10	004100385
19/64	111	78	2,65	10	004100386
5/16	114	81	3,20	10	004100387
21/64	117	84	3,40	10	004100388
11/32	121	87	3,95	5	004100389
23/64	124	89	4,05	5	004100390
3/8	127	92	4,15	5	004100391



410AS/SP21	€	U	U
Ø 1/16-5/64-3/32-7/64 1/8-9/64-5/32-11/64-3/16 13/64-7/32-15/64-1/4 17/64-9/32-19/64-5/16 21/64-11/32-23/64-3/8	59,00	1	004100429
410AS/SPV1	21,80	1	004100430



410AS/SEL21	€	U	U
Ø 1/16-5/64-3/32-7/64 1/8-9/64-5/32-11/64-3/16 13/64-7/32-15/64-1/4 17/64-9/32-19/64-5/16 21/64-11/32-23/64-3/8	47,50	1	004100433

## 412

brocas cilíndricas série curta HSS - totalmente rectificadas

R ≤ 700 N/mm<sup>2</sup>  
HV ~ 750÷820



DIN 338 ISO 235

Ø mm	L mm	L1 mm	€	U	U
0,50	22	6	2,45	10	004120030
1,00	34	12	1,55	10	004120040
1,25	38	16	1,70	10	004120043
1,50	40	18	1,45	10	004120046
1,75	46	22	1,40	10	004120049
2,00	49	24	1,20	10	004120052
2,25	53	27	1,50	10	004120055
2,50	57	30	1,30	10	004120058
2,75	61	33	1,55	10	004120061
3,00	61	33	1,40	10	004120064
3,25	65	36	1,80	10	004120067
3,50	70	39	1,65	10	004120070
3,75	70	39	2,00	10	004120073
4,00	75	43	1,80	10	004120076
4,25	75	43	2,25	10	004120079
4,50	80	47	2,10	10	004120082
4,75	80	47	2,50	10	004120085
5,00	86	52	2,25	10	004120088
5,25	86	52	3,25	10	004120091
5,50	93	57	2,95	10	004120094
5,75	93	57	3,55	10	004120097
6,00	93	57	3,15	10	004120100
6,25	101	63	4,50	10	004120103
6,50	101	63	3,95	10	004120106
6,75	109	69	5,05	10	004120109
7,00	109	69	4,65	10	004120112
7,25	109	69	5,70	5	004120115
7,50	109	69	4,90	5	004120118
7,75	117	75	6,45	5	004120121
8,00	117	75	5,90	5	004120124
8,25	117	75	7,10	5	004120127
8,50	117	75	7,20	5	004120130
8,75	125	81	8,00	5	004120133
9,00	125	81	7,55	5	004120136
9,25	125	81	8,75	5	004120139
9,50	125	81	7,85	5	004120142
9,75	133	87	9,75	5	004120145
10,00	133	87	8,65	5	004120148
10,25	133	87	13,20	5	004120149
10,50	133	87	11,70	5	004120150
10,75	142	94	15,90	5	004120151
11,00	142	94	14,00	5	004120152
11,25	142	94	16,90	5	004120153
11,50	142	94	14,80	5	004120154
11,75	142	94	18,40	5	004120155
12,00	151	94	16,10	5	004120156
12,25	151	101	20,00	5	004120157
12,50	151	101	17,30	5	004120158
12,75	151	101	22,70	5	004120159
13,00	151	101	18,30	5	004120160



412/SP19	€	U	U
Ø 1÷10 x 0,5 mm	81,00	1	004120419
412/SPV1	21,30	1	004120420
412/SP25	167,00	1	004120425
Ø 1÷13 x 0,5 mm			
412/SPV2	31,00	1	004120426
412/SP49	398,00	1	004120449
Ø 1÷13 x 0,25 mm			
412/SPV4	95,00	1	004120451

## 412/C150



412/C150	€	U	U
	487,00	1	004120450

412	Ø	n.
	Ø 3 mm	20
	Ø 1 - 1,5 - 2 - 2,5 - 3 - 3,5 - 4 - 4,5 - 5 mm	10
	Ø 5,5 - 6 - 6,5 - 7 - 7,5 - 8 - 8,5 - 9 - 9,5 - 10 mm	5

365x230x47 mm - 3,3 kg



412/SP91	€	U	U
Ø 1÷10 x 0,10 mm	518,00	1	004120452

Beta

## 412A

brocas cilíndricas série curta  
HSS - totalmente rectificadas  
e acabamento brunido

R ≤ 700 N/mm<sup>2</sup>  
HV ~ 750+820



DIN 338 ISO 235

Ø mm	L mm	L1 mm	€	🔧	📦
13,50	160	108	28,50	3	004120202
14,00	160	108	29,50	3	004120204
14,50	169	114	32,00	3	004120206
15,00	169	114	33,50	3	004120208
15,50	178	120	38,50	3	004120210
16,00	178	120	40,00	3	004120212
16,50	186	125	41,00	1	004120213
17,00	186	125	44,00	1	004120214
17,50	194	130	47,00	1	004120215
18,00	194	130	49,50	1	004120216
18,50	202	135	53,00	1	004120217
19,00	202	135	55,50	1	004120218
19,50	210	140	62,50	1	004120219
20,00	210	140	63,50	1	004120220

## 412L

brocas cilíndricas série longa  
HSS - totalmente rectificadas  
e acabamento brunido

R ≤ 700 N/mm<sup>2</sup>  
HV ~ 750+820



Ø mm	L mm	L1 mm	€	🔧	📦
2,00	85	56	3,20	10	004120232
2,50	95	62	3,40	10	004120234
3,00	100	66	3,50	10	004120236
3,50	112	73	4,05	10	004120238
4,00	119	78	4,40	10	004120240
4,50	126	82	5,35	10	004120242
5,00	132	87	5,60	10	004120244
5,50	139	91	7,00	10	004120246
6,00	139	91	7,55	10	004120248
6,50	148	97	8,95	5	004120250
7,00	156	102	10,40	5	004120252
8,00	165	109	13,90	5	004120256
9,00	175	115	16,40	5	004120260
10,00	184	121	18,00	5	004120264

## 414

brocas cilíndricas série curta  
HSS-TIN - totalmente rectificadas

R ≤ 900 N/mm<sup>2</sup>  
HV 0,05 ~ 2500



DIN 338 ISO 235

Ø mm	L mm	L1 mm	€	🔧	📦
1,00	34	12	2,10	10	004140040
1,25	38	16	2,45	10	004140042
1,50	40	18	1,90	10	004140046
1,75	46	22	2,45	10	004140048
2,00	49	24	1,95	10	004140052
2,25	53	27	2,50	10	004140054
2,50	57	30	2,10	10	004140058
2,75	61	33	2,85	10	004140060
3,00	61	33	2,35	10	004140064
3,25	65	36	3,00	10	004140066
3,50	70	39	2,80	10	004140070
3,75	70	39	3,15	10	004140072
4,00	75	43	2,80	10	004140076
4,25	75	43	3,50	10	004140078
4,50	80	47	3,10	10	004140082
4,75	80	47	3,95	10	004140084
5,00	86	52	3,60	10	004140088
5,25	86	52	5,15	10	004140090
5,50	93	57	4,40	10	004140094
5,75	93	57	5,35	10	004140096
6,00	93	57	4,95	10	004140100
6,25	101	63	6,35	10	004140102
6,50	101	63	5,55	10	004140106
6,75	109	69	7,55	10	004140108
7,00	109	69	6,15	10	004140112
7,25	109	69	8,30	5	004140114
7,50	109	69	7,45	5	004140118
7,75	117	75	9,75	5	004140120
8,00	117	75	8,65	5	004140124
8,25	117	75	10,10	5	004140125
8,50	117	75	8,95	5	004140130
8,75	125	81	12,60	5	004140132
9,00	125	81	11,30	5	004140136
9,25	125	81	14,20	5	004140138
9,50	125	81	12,30	5	004140142
9,75	133	87	15,00	5	004140144
10,00	133	87	13,10	5	004140148
10,50	133	87	15,50	5	004140150
11,00	142	94	16,90	5	004140152
11,50	142	94	18,30	5	004140154
12,00	151	101	19,70	5	004140156
12,50	151	101	22,60	5	004140158
13,00	151	101	23,70	5	004140160



	€	🔧	📦
414/SP19 Ø 1÷10 x 0,5 mm	116,00	1	004140419
414/SPV1	21,80	1	004140420
414/SP25 Ø 1÷13 x 0,5 mm	235,00	1	004140425
414/SPV2	31,00	1	004140426
414/SP49 Ø 1÷13 x 0,25 mm	507,00	1	004140429
414/SPV4	95,00	1	004140430

## 414/C116



	€	🔧	📦
414/C116	471,00	1	004140450

414	Ø 1 - 1,5 - 2 - 2,5 - 3 - 3,5 - 4 - 4,5 - 5 mm	n.
	Ø 5,5 - 6 - 6,5 - 7 - 7,5 - 8 mm	10
	Ø 8,5 - 9 - 9,5 - 10 mm	3
		2

📏 365x230x47 mm - 📦 2,7 Kg

## 415

brocas cilíndricas série curta  
HSS-CO 8% - totalmente rectificadas

R ≤ 1400 N/mm<sup>2</sup>  
HV ~ 850+920



DIN 338 ISO 235

Ø mm	L mm	L1 mm	€	🔧	📦
0,50	22	6	5,80	10	004150029
1,00	34	12	2,85	10	004150040
1,25	38	16	3,20	10	004150043
1,50	40	18	2,90	10	004150046
1,75	46	22	3,10	10	004150049
2,00	49	24	2,80	10	004150052
2,25	53	27	3,35	10	004150055
2,50	57	30	3,10	10	004150058
2,75	61	33	3,35	10	004150061
3,00	61	33	3,10	10	004150064
3,25	65	36	4,35	10	004150067
3,50	70	39	3,90	10	004150070
3,75	70	39	4,95	10	004150073
4,00	75	43	4,35	10	004150076
4,25	75	43	5,45	10	004150079
4,50	80	47	5,05	10	004150082
4,75	80	47	5,70	10	004150085
5,00	86	52	5,25	10	004150088
5,25	86	52	7,60	10	004150091
5,50	93	57	7,00	10	004150094
5,75	93	57	8,00	10	004150097
6,00	93	57	7,35	10	004150100
6,25	101	63	10,20	10	004150103
6,50	101	63	9,05	10	004150106
6,75	109	69	12,00	10	004150109
7,00	109	69	10,70	10	004150112
7,25	109	69	12,80	5	004150115
7,50	109	69	11,60	5	004150118
7,75	117	75	14,80	5	004150121
8,00	117	75	13,70	5	004150124
8,25	117	75	16,40	5	004150127
8,50	117	75	15,30	5	004150130
8,75	125	81	20,20	5	004150133
9,00	125	81	18,00	5	004150136
9,25	125	81	21,00	5	004150139
9,50	125	81	19,30	5	004150142
9,75	133	87	23,30	5	004150145
10,00	133	87	21,30	5	004150148
10,25	133	87	27,50	5	004150149
10,50	133	87	23,50	5	004150150
10,75	142	94	31,00	5	004150151
11,00	142	94	27,00	5	004150152
11,25	142	94	34,00	5	004150153
11,50	142	94	31,00	5	004150154
11,75	142	94	35,00	5	004150155
12,00	151	101	33,00	5	004150156
12,25	151	101	41,00	5	004150157
12,50	151	101	34,50	5	004150158
12,75	151	101	46,00	5	004150159
13,00	151	101	38,00	5	004150160

Beta



Ø mm	L mm	L1 mm	€	U	PC
14,00	160	108	66,50	3	004150164
15,00	169	114	79,50	3	004150168
16,00	178	120	97,50	3	004150172
17,00	186	125	111,00	1	004150174
18,00	194	130	123,00	1	004150176
19,00	202	135	141,00	1	004150178
20,00	210	140	159,00	1	004150180



	€	U	PC
415/SP19 Ø 1÷10 x 0,5 mm	163,00	1	004150419
415/SPV1	21,30	1	004150420
415/SP25 Ø 1÷13 x 0,5 mm	338,00	1	004150425
415/SPV2	31,00	1	004150426
415/SP49	842,00	1	004150431
415/SPV4	95,00	1	004150432

## 415/C116



	€	U	PC
415/C116	700,00	1	004150450

415	Ø	n.
	1 - 1,5 - 2 - 2,5 - 3 - 3,5 - 4 - 4,5 - 5 mm	10
	Ø 5,5 - 6 - 6,5 - 7 - 7,5 - 8 mm	3
	Ø 8,5 - 9 - 9,5 - 10 mm	2

365x230x47 mm - 2,7 kg



	€	U	PC
415/SP91 Ø 1÷10 x 0,10 mm	979,00	1	004150460

## 416

broca cilíndrica, para furar chão,  
com duas lâminas

R ≤ 900 N/mm<sup>2</sup>  
HV ~ 820+850

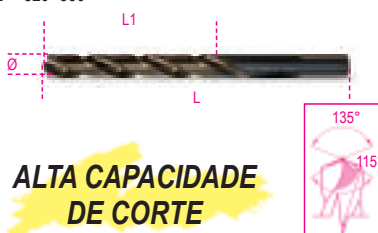

**ALTA CAPACIDADE  
DE CORTE**

DIN 338

Ø mm	L mm	L1 mm	€	U	PC
1,00	34	12	2,25	10	004160010
1,50	40	18	2,25	10	004160015
2,00	49	24	2,25	10	004160020
2,50	57	30	2,35	10	004160025
3,00	61	33	2,55	10	004160030
3,50	70	39	2,85	10	004160035
4,00	75	43	3,20	10	004160040
4,50	80	47	3,50	10	004160045
5,00	86	52	3,95	10	004160050
5,50	93	57	5,10	10	004160055
6,00	93	57	5,55	10	004160060
6,50	101	63	6,45	10	004160065
7,00	109	69	7,55	10	004160070
7,50	109	69	8,10	5	004160075
8,00	117	75	9,60	5	004160080
8,50	117	75	10,40	5	004160085
9,00	125	81	12,40	5	004160090
9,50	125	81	13,00	5	004160095
10,00	133	87	15,00	5	004160100



	€	U	PC
416/SP19 Ø 1÷10 x 0,5 mm	115,00	1	004160419

## 417

brocas cilíndricas para pedra,  
série curta em aço fresado,  
com ponta em diamante



DIN 8039

Ø mm	L mm	€	U	PC
3	70	3,10	10	004170003
4	75	3,10	10	004170004
5	85	3,25	10	004170005
5L	150	7,20	5	004170105
6	100	3,35	10	004170007
6L	150	7,20	5	004170106
7	120	3,75	10	004170009
8	120	4,15	10	004170010
8L	200	7,85	5	004170113
9	120	4,75	10	004170011
10	120	5,55	10	004170012
10L	200	9,50	5	004170120
12	150	7,35	10	004170014
12L	200	10,20	5	004170125
14	150	10,10	5	004170016
16	150	12,50	5	004170018



	€	U	PC
417/SP8 Ø 3-4-5-6-8-9-10-12 mm	46,50	1	004170100

## 419

brocas para pedra, corpo fresado  
com ponta em diamante



DIN 8039

ØxL mm	€	U	PC
4x110	6,35	10	004190002
5x110	6,35	10	004190004
5x160	7,00	10	004190006
6x110	6,25	10	004190012
6x160	6,80	10	004190014
6x210	9,20	10	004190016
7x160	7,55	10	004190028
8x110	6,65	10	004190030
8x160	7,20	10	004190032
8x210	8,75	10	004190034
8x260	11,90	10	004190036
8x460	27,00	10	004190042
9x160	9,05	5	004190044
10x160	8,75	5	004190050
10x210	10,50	5	004190052
10x260	13,10	5	004190054
10x310	18,60	5	004190056
10x460	29,00	5	004190060
12x160	10,20	5	004190064
12x210	13,70	5	004190066
12x260	14,80	5	004190068
12x460	31,00	5	004190074
14x160	12,60	3	004190086
14x260	16,90	3	004190090
14x310	24,60	3	004190092
14x460	32,00	3	004190096
16x210	20,80	3	004190112
16x250	21,80	3	004190114
16x300	26,00	3	004190116
16x450	35,00	3	004190120
18x250	28,00	1	004190124
20x310	28,00	1	004190128

**Beta**

## 421

Jogo de 6 escareadores com pino guia, qualidade superior, em HSS



M	L mm	Ø mm	D1 mm	D mm	€	🔧	📦
3	71	6	3,2	5	22,90	1	004210003
4	71	8	4,3	5	22,90	1	004210004
5	80	10	5,3	8	22,90	1	004210005
6	80	11	6,4	8	23,50	1	004210006
8	100	15	8,4	12,5	38,00	1	004210008
10	100	18	10,5	12,5	45,50	1	004210010
12	100	20	13,0	12,5	50,00	1	004210012



DIN 373

	€	🔧	📦
421/SP6	189,00	1	004210019
M 3-4-5-6-8-10			
421/SPV	13,70	1	004210020

## 422

pontas de centrar, ângulo de escarear 60°, em HSS

• Para realizar furos de forma rápida e segura



DIN 333/A

Ø mm	D mm	L mm	€	🔧	📦
1,60	4,0	35,5	7,10	1	004220116
2,50	6,3	45,0	8,20	1	004220125
3,15	8,0	50,0	9,30	1	004220131

## 423

brocas especiais para soldadores em HSS - totalmente rectificadas



Ø mm	L mm	€	🔧	📦
6	66	14,50	5	004230006
7	74	17,90	5	004230007
8	79	19,60	5	004230008
10	89	22,70	5	004230010

## 423A

brocas especiais para soldadores com ponta guia de centragem em HSS - totalmente rectificadas



DIN 1412/E

Ø mm	L mm	€	🔧	📦
6,5	40	21,30	1	004230015
8,0	40	22,90	1	004230020

## 424

brocas cónicas para furar e alargar em HSS

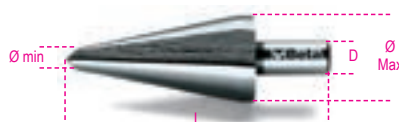

	L mm	Ø mm	D mm	€	🔧	📦
424/1	58	3÷14	6	26,00	2	004240001
424/2	63	6÷20	8	44,50	2	004240002
424/3	60	16÷30	10	75,50	2	004240003
424/4	80	3÷22	8	90,50	1	004240004
424/5	102	3÷31	10	124,00	1	004240005
424/6	86	26÷40	13	157,00	1	004240006
424/7	89	36÷50	13	236,00	1	004240007
424/8	90	40÷61	13	393,00	1	004240008



	€	🔧	📦
424/SP3	151,00	1	004240019
424/1+424/2+424/3			
Ø 3÷30 mm			
424/SPV	21,30	1	004240020

## 425

fresas cónicas de diâmetros múltiplos em HSS



	L mm	Ø mm	S mm	D mm	€	🔧	📦
425/1	70	4÷12	1	6	44,50	2	004250010
425/2	55	4÷12	2	6	47,00	2	004250012
425/3	85	4÷20	2	10	66,50	2	004250015
425/4	85	12÷20	1	10	123,00	1	004250016
425/5	97	20÷30	1	10	205,00	1	004250017
425/6	75	4÷30	2	10	143,00	1	004250020
425/7	97	30÷40	1	13	286,00	1	004250025
425/8	100	40÷50	1	13	406,00	1	004250029



	€	🔧	📦
425/SP3	262,00	1	004250030
425/1+425/3+425/6			
Ø 4÷30 mm			
425/SPV	21,30	1	004250035

## 426

fresas para desbaste e aberturas em HSS, 3 lâminas



DIN 335-C

GR	Ø mm	L mm	Ø1 mm	€	🔧	📦
1	4,3	44	4	18,00	3	004260001
2	5,3	44	4	18,00	3	004260002
3	6,3	44	5	18,60	3	004260003
4	7,3	44	6	21,30	3	004260004
5	8,3	50	6	21,30	3	004260005
6	9,4	50	6	23,50	3	004260006
7	10,4	54	6	26,00	3	004260007
8	12,4	54	8	29,00	3	004260008
9	15,0	56	10	32,00	3	004260009
10	16,5	60	10	34,00	3	004260010
11	20,5	63	10	46,00	3	004260011
12	25,0	66	10	72,50	3	004260012
13	28,0	71	12	96,00	3	004260013
14	31,0	71	12	101,50	3	004260014



	€	🔧	📦
426/SP6	200,00	1	004260030
GR 3-5-7-8-10-11			
Ø 6,3÷20,5 mm			
426/SPV	21,30	1	004260035

## 426SB

fresas para desbaste e vazar em HSS



GR	Ø mm	D mm	L mm	€	🔧	📦	
426/SB1	1	2÷5	6	45	20,20	1	004260101
426/SB2	2	5÷10	8	48	24,60	1	004260102
426/SB3	3	10÷15	10	65	44,50	1	004260103
426/SB4	4	15÷20	12	85	86,00	1	004260104
426/SB5	5	20÷25	15	102	144,00	1	004260105
426/SB6	6	25÷30	15	115	241,00	1	004260106



<b>426SB/SP4</b>	€ 202,00	1	004260130
426/SB1-426/SB2			
426/SB3-426/SB4			
Ø 2=20 mm			
<b>426SB/SPV1</b>	€ 21,30	1	004260135

## 426MD-3

Conjunto mini fresas rotativas em metal duro

• Corte transversal suave com quebras



	L mm	Ø mm	€		
426MD-3/OV3	38,2	3	10,80	1	004260331
426MD-3/CP3	38,1	3	10,80	1	004260332
426MD-3/CT3	37,8	3	10,80	1	004260333
426MD-3/F3	38,3	3	10,80	1	004260334
426MD-3/TA3	38,3	3	10,80	1	004260335
426MD-3/T3	38,3	3	10,80	1	004260336
426MD-3/OG3	38,1	3	10,80	1	004260337
426MD-3/S3	38,0	3	10,80	1	004260338
426MD-3/FA3	38,2	3	10,80	1	004260339



<b>426MD-3/FA9</b>	€ 97,50	1	004260349
426MD-3/OV3 - 426MD-3/CP3			
426MD-3/CT3 - 426MD-3/F3			
426MD-3/TA3 - 426MD-3/T3			
426MD-3/OG3 - 426MD-3/S3			
426MD-3/FA3			

## 426MD

limas rotativas, em metal endurecido

corte transversal HM6



	L mm	Ø mm	€		
426MD/OV6	50	6	31,50	1	004260531
426MD/OV9,5	61	9,5	38,50	1	004260541
426MD/OV12	67	12	53,50	1	004260521
426MD/OV16	69	16	65,50	1	004260551
426MD/CP6	50	6	31,50	1	004260532
426MD/CP8	63	8	34,50	1	004260512
426MD/CP9,5	63	9,5	38,50	1	004260542
426MD/CP12	69	12	53,50	1	004260522
426MD/CP16	69	16	76,00	1	004260552
426MD/CT6	50	6	31,50	1	004260533
426MD/CT8	63	8	34,50	1	004260513
426MD/CT9,5	63	9,5	38,50	1	004260543
426MD/CT12	69	12	53,50	1	004260523
426MD/CT16	69	16	76,00	1	004260553
426MD/F6	50	6	31,50	1	004260534
426MD/F8	63	8	34,50	1	004260514
426MD/F9,5	63	9,5	38,50	1	004260544
426MD/F12	69	12	53,50	1	004260524
426MD/F16	69	16	60,00	1	004260554
426MD/TA6	50	6	31,50	1	004260535
426MD/TA8	67	8	34,50	1	004260515
426MD/TA9,5	72	9,5	38,50	1	004260545
426MD/TA12	73	12	53,50	1	004260525
426MD/TA16	78	16	76,00	1	004260555
426MD/T6	50	6	31,50	1	004260536
426MD/T8	63	8	34,50	1	004260516
426MD/T9,5	63	9,5	38,50	1	004260546
426MD/T12	69	12	53,50	1	004260526
426MD/T16	70	16	60,00	1	004260556
426MD/OG6	50	6	31,50	1	004260537
426MD/OG8	63	8	34,50	1	004260517
426MD/OG10	70	10	38,50	1	004260547
426MD/OG12	76	12	53,50	1	004260527
426MD/OG16	81	16	76,00	1	004260557
426MD/S6	50	6	31,50	1	004260538
426MD/S8	51	8	34,50	1	004260518
426MD/S9,5	53	9,5	38,50	1	004260548
426MD/S12	56	12	53,50	1	004260528
426MD/S16	59	16	60,00	1	004260558
426MD/FA6	50	6	31,50	1	004260539
426MD/FA8	63	8	34,50	1	004260519
426MD/FA9,5	63	9,5	38,50	1	004260549
426MD/FA12	69	12	53,50	1	004260529
426MD/FA16	69	16	65,50	1	004260559



<b>426MD/SP10</b>	€ 393,00	1	004260510
426MD/CP-426MD/CT-426MD/F			
426MD/T-426MD/S			
Ø 8-12 mm			

## 427

extractores de cones Morse



DIN 317

GR	L mm	A mm	€		
0	92	13	10,20	3	004270000
1-2	140	19	12,60	3	004270002
3	190	25	18,00	3	004270003
4	225	30	29,00	3	004270004
5-6	260	35	56,50	3	004270006

## 428FP

machos mecânicos para furos vazantes  
passo largo em HSS



ISO 529

M	mm	L mm	L1 mm	€		
3x0,5	2,7	56	11	15,00	10	004280003
4x0,7	3,4	63	13	15,00	10	004280004
5x0,8	4,9	70	16	15,00	10	004280005
6x1	4,9	80	19	15,90	10	004280006
8x1,25	6,2	90	22	19,10	10	004280008
10x1,5	8,0	100	24	22,40	10	004280010
12x1,75	7,0	110	29	29,50	5	004280012
14x2	9,0	110	30	36,00	5	004280014
16x2	9,0	110	30	43,50	5	004280016
18x2,5	11,0	125	34	56,00	3	004280018
20x2,5	12,0	140	34	63,00	3	004280020
22x2,5	14,5	140	34	75,50	3	004280022
24x3	14,5	160	38	82,00	3	004280024

## 428FC

machos mecânicos para furos cegos  
passo largo em HSS



ISO 529

M	■ mm	L mm	L1 mm	€	🔧	📦
3x0,5	2,7	56	11	18,00	10	004280103
4x0,7	3,4	63	13	18,00	10	004280104
5x0,8	4,9	70	16	18,00	10	004280105
6x1	4,9	80	19	18,60	10	004280106
8x1,25	6,2	90	22	20,20	5	004280108
10x1,5	8,0	100	24	24,00	10	004280110
12x1,75	7,0	110	29	31,00	5	004280112
14x2	9,0	110	30	41,00	5	004280114
16x2	9,0	110	30	49,00	5	004280116
18x2,5	11,0	125	34	65,00	3	004280118
20x2,5	12,0	140	34	69,00	3	004280120
22x2,5	14,5	140	34	84,00	3	004280122
24x3	14,5	160	38	89,50	3	004280124

## 428/C14

jogo de 14 machos mecânicos  
428FP+428FC



428/C14	€ 326,00	🔧 1	📦 004280201
428FP M3÷12			
428FC M3÷12			
428/SPV	€ 17,50	🔧 1	📦 004280202

## 429FP

machos mecânicos para furos vazantes  
passo largo em HSS-CO 5%



ISO 529

M	■ mm	L mm	L1 mm	€	🔧	📦
3x0,5	2,7	56	11	19,70	5	004290003
4x0,7	3,4	63	13	19,70	5	004290004
5x0,8	4,9	70	16	19,70	5	004290005
6x1	4,9	80	19	21,30	5	004290006
8x1,25	6,2	90	22	23,50	5	004290008
10x1,5	8,0	100	24	27,50	5	004290010
12x1,75	7,0	110	29	35,00	5	004290012
14x2	9,0	110	30	46,00	5	004290014

## 429FC

machos mecânicos para furos cegos  
passo largo em HSS-CO 5%

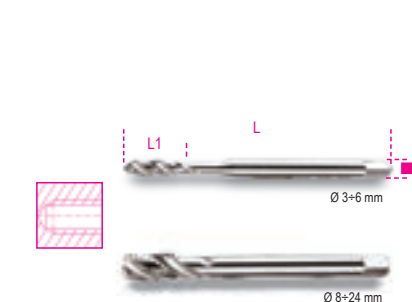

ISO 529

M	■ mm	L mm	L1 mm	€	🔧	📦
3x0,5	2,7	56	11	24,00	5	004290103
4x0,7	3,4	63	13	24,00	5	004290104
5x0,8	4,9	70	16	24,00	5	004290105
6x1	4,9	80	19	25,00	5	004290106
8x1,25	6,2	90	22	27,50	5	004290108
10x1,5	8,0	100	24	34,50	5	004290110
12x1,75	7,0	110	29	41,50	5	004290112
14x2	9,0	110	30	53,00	5	004290114

## 429/C14

jogo de 14 machos mecânicos  
429FP+429FC



429/C14	€ 402,00	🔧 1	📦 004290201
429FP M3÷12			
429FC M3÷12			
428/SPV	€ 17,50	🔧 1	📦 004280202

## 430

machos manuais, passo largo  
em aço ao cromo

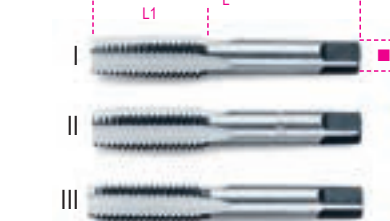

ISO 529

M	■ mm	L mm	L1 mm	€	🔧	📦
2x0,4	2,5	36	11	12,80	5	004300002
3x0,5	2,5	40	12	8,95	5	004300003
4x0,7	3,0	45	14	8,95	5	004300004
5x0,8	4,0	48	16	9,30	5	004300005
6x1	5,0	50	18	9,50	5	004300006
7x1	4,5	50	18	12,00	5	004300007
8x1,25	5,0	56	22	12,30	3	004300008
9x1,25	5,5	63	22	16,40	3	004300009
10x1,5	6,0	70	25	15,60	3	004300010
11x1,5	7,0	70	25	20,30	3	004300011
12x1,75	7,0	75	30	19,70	3	004300012
14x2	8,0	80	32	25,00	3	004300014
16x2	10,0	80	32	30,00	3	004300016
18x2,5	11,0	95	40	40,50	1	004300018
20x2,5	12,0	95	40	49,00	1	004300020
22x2,5	14,5	100	40	58,50	1	004300022
24x3	14,5	110	50	69,00	1	004300024



430/SP21	€ 112,00	🔧 1	📦 004300201
M 3-4-5-6-8-10-12			
430/SPV	€ 21,80	🔧 1	📦 004300202

## 430ASW

machos manuais rosca Whitworth  
em aço ao cromo

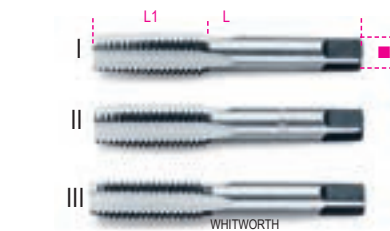

DIN 352

BSW	■ mm	L mm	L1 mm	€	🔧	📦
1/8x40	2,7	40	12	8,85	5	004300031
5/32x32	3,4	45	14	8,85	5	004300032
3/16x24	4,3	48	18	8,85	5	004300033
1/4x20	4,9	50	22	10,20	5	004300034
5/16x18	4,9	56	25	12,60	3	004300035
3/8x16	5,5	70	28	16,40	3	004300036
7/16x14	6,2	70	30	18,60	3	004300037
1/2x12	7,0	75	32	20,80	3	004300038
9/16x12	9,0	80	32	25,00	1	004300039
5/8x11	9,0	80	38	31,00	1	004300040
3/4x10	11,0	95	40	44,00	1	004300041
7/8x9	14,5	100	40	56,00	1	004300042
1"x8	16,0	110	50	71,50	1	004300043

## 430ASC

machos manuais rosca UNC  
em aço ao crómio

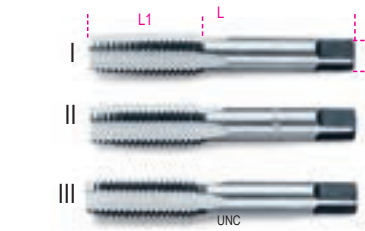

ANSI B1.1

UNC	mm	L	L1	€	U	PC
1/4x20	4,9	70	30	13,10	5	004300051
5/16x18	4,9	70	30	16,90	5	004300052
3/8x16	5,5	75	35	19,10	3	004300053
7/16x14	6,2	80	40	24,60	3	004300054
1/2x13	7,0	85	45	32,00	3	004300055
9/16x12	9,0	90	45	38,00	3	004300056
5/8x11	9,0	100	47	44,00	3	004300057
3/4x10	11,0	110	50	60,00	3	004300058
7/8x9	14,5	120	60	69,00	1	004300059
1"x8	16,0	130	60	77,00	1	004300060

## 431

machos manuais, passo largo em HSS



DIN 352 UNI 4535

M	mm	L	L1	€	U	PC
3x0,5	2,5	40	12	17,50	5	004310003
4x0,7	3,0	45	14	17,50	5	004310004
5x0,8	4,0	48	16	18,00	5	004310005
6x1	5,0	50	18	18,00	5	004310006
7x1	5,0	50	18	24,20	5	004310007
8x1,25	5,0	56	22	21,80	3	004310008
10x1,5	6,0	70	25	27,00	3	004310010
12x1,75	7,0	75	30	40,00	3	004310012
14x2	9,0	80	32	54,50	1	004310014
16x2	9,0	80	32	62,50	1	004310016
18x2,5	11,0	95	40	93,00	1	004310018
20x2,5	12,0	95	40	100,00	1	004310020
22x2,5	12,0	100	40	142,00	1	004310022
24x3	14,5	110	50	160,00	1	004310024



	€	U	PC
431/SP21	202,00	1	004310201
M 3-4-5-6-8-10-12			
431/SPV	21,80	1	004310202

## 433

machos manuais, passo fino  
em aço ao crómio

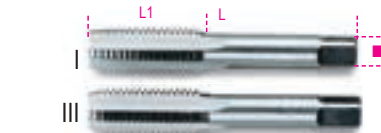

DIN 2181 UNI 4535

M	mm	L	L1	€	U	PC
6x0,75	4,5	48	16	7,75	5	004330201
7x0,75	4,5	56	18	9,75	5	004330202
8x0,75	5,0	50	16	9,75	5	004330203
8x1	5,0	56	16	9,75	5	004330204
9x0,75	6,0	63	22	12,60	5	004330205
9x1	6,0	63	22	12,60	5	004330206
10x0,75	6,5	63	18	12,60	5	004330207
10x1	6,5	63	18	12,60	5	004330208
10x1,25	6,5	63	18	12,60	5	004330209
11x0,75	7,0	70	25	17,10	3	004330210
11x1	7,0	70	25	17,10	3	004330211
11x1,25	7,0	70	25	17,10	3	004330212
12x0,75	7,0	70	20	16,50	3	004330213
12x1	7,0	70	20	16,50	3	004330214
12x1,25	7,0	70	20	16,50	3	004330215
12x1,5	7,0	70	20	16,50	3	004330216
14x1	8,0	80	32	21,50	1	004330217
14x1,25	8,0	80	32	21,50	1	004330218
14x1,5	8,0	80	32	21,50	1	004330219
16x1	10,0	80	32	25,50	1	004330220
16x1,5	10,0	80	32	25,50	1	004330221
18x1,5	11,0	95	40	31,00	1	004330222
18x2	11,0	80	25	39,50	1	004330223
20x1,5	14,5	80	22	45,00	1	004330224
22x1,5	14,5	80	22	53,00	1	004330225
24x1,5	14,5	80	22	62,50	1	004330226
24x2	14,5	80	22	62,50	1	004330227

## 433ASF

machos manuais, passo fino, rosca UNF  
em aço ao crómio

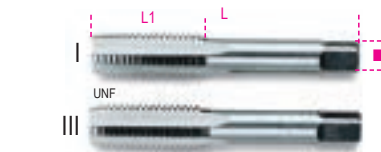

ANSI B1.1

UNF	mm	L	L1	€	U	PC
1/4x28	4,9	70	30	9,85	5	004330301
5/16x24	4,9	70	30	11,70	5	004330302
3/8x24	5,5	75	35	13,10	3	004330303
7/16x20	6,2	80	40	16,90	3	004330304
1/2x20	7,0	85	45	21,30	3	004330305
9/16x18	9,0	90	45	26,00	3	004330306
5/8x18	9,0	100	47	30,00	3	004330307
3/4x16	11,0	110	50	41,00	3	004330308
7/8x14	14,5	120	60	53,00	1	004330309
1"x12	16,0	130	60	72,00	1	004330310

## 433ASG

machos manuais rosca GAS cilíndrica  
em aço ao crómio



DIN 5157

GAS	mm	L	L1	€	U	PC
1/8x28	5,5	65	18	14,00	1	004330401
1/4x19	9,0	70	24	17,70	1	004330402
3/8x19	9,0	75	25	21,50	1	004330403
1/2x14	12,0	80	31	31,50	1	004330405
3/4x14	16,0	90	33	51,00	1	004330408
1"x11	20,0	100	39	81,50	1	004330410

## 434

machos manuais, passo fino em HSS

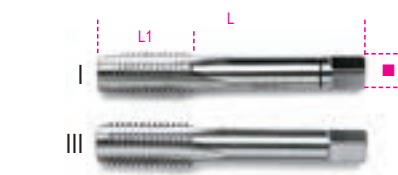

DIN 2181 UNI 4535

M	mm	L	L1	€	U	PC
6x0,75	4,5	48	16	22,90	5	004340001
8x0,75	5,0	56	16	25,50	5	004340003
8x1	5,0	56	16	25,50	5	004340004
10x0,75	6,5	63	18	33,00	5	004340007
10x1	6,5	63	18	33,00	5	004340008
10x1,25	6,5	63	18	33,00	5	004340009
12x1	7,0	70	20	35,00	3	004340014
12x1,25	7,0	70	20	35,00	3	004340015
12x1,5	7,0	70	20	35,00	3	004340016
13x1,5	9,0	70	20	76,50	1	004340017
14x1	9,0	70	20	44,00	1	004340018
14x1,25	9,0	70	20	44,00	1	004340019
14x1,5	9,0	70	20	37,50	1	004340020
15x1,5	9,0	70	20	76,50	1	004340021
16x1	9,0	70	20	48,00	1	004340022
16x1,5	9,0	70	20	40,50	1	004340023
18x1,5	11,0	80	22	52,00	1	004340024
18x2	11,0	90	25	64,50	1	004340025
20x1,25	12,0	80	22	94,00	1	004340026
20x1,5	12,0	80	22	56,50	1	004340027
20x2	12,0	90	25	69,00	1	004340028
22x1,5	14,5	80	22	79,50	1	004340029
24x1	14,5	80	22	108,00	1	004340030
24x1,5	14,5	80	22	90,00	1	004340031
24x2	14,5	80	22	94,00	1	004340032

## 435

desandadores de machos extensíveis  
corpo em aço



DIN 1814

	mm	L	€	U	PC
435/0	M2=M8	140	15,30	3	004350007
435/1	M2=M8	180	18,60	2	004350009
435/1,5	M3=M10	180	19,70	2	004350011
435/2	M3=M12	260	27,00	2	004350013
435/3	M4=M12	380	46,50	1	004350020
435/4	M5=M20	490	72,00	1	004350027
435/5	M9=M27	620	163,00	1	004350032
	M13=M32				

Beta

## 435G

desandadores de machos extensíveis  
corpo em liga leveira



DIN 1814

	□ mm	L mm	€		
435G/0	2÷5 M1÷M8	130	10,70	5	004350108
435G/1	2÷6 M1÷M10	190	13,10	5	004350110
435G/1,5	2÷7 M2÷M12	175	13,80	5	004350112
435G/2	3,4÷7 M4÷M12	280	22,60	5	004350114
435G/3	4,9÷12 M5÷M20	380	37,00	2	004350121
435G/4	7÷16 M11÷M27	500	58,50	2	004350127
435G/5	7÷18 M13÷M32	700	93,00	1	004350132
435G/6	11÷24 M18÷M42	800	152,00	1	004350142

## 436

punhos desandadores de machos  
com roquete reversível

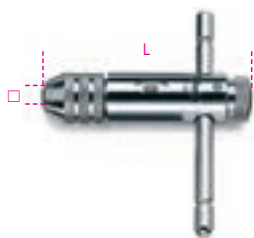

	□ mm	L mm	€		
436/1	2÷5 M3÷M8	85	25,50	5	004360002
436/2	4,6÷8 M5÷M12	110	32,50	5	004360004

## 436L

punhos desandadores de machos  
com roquete reversível, tipo longo



	□ mm	L mm	€		
436L/1	2÷5 M3÷M8	245	40,00	2	004360012
436L/2	4,6÷8 M5÷M12	295	47,50	2	004360014

## 436R

buchas de substituição  
para artigos 436 e 436L

	€		
436R/1	4,70	1	004360022
436R/2	5,25	1	004360024

## 437C

jogo para reparação de roscas de velas de  
ignição, M14x1.25 mm

• Altura helicoidal: 8.40 - 12.40 - 16.40 mm (5 pcs/tamanho)



	€		
437C	106,50	1	004370100

## 437C/...

helicóides em aço inoxidável para ref. 437C



H mm	€		
8.4	26,00	1	004370108
12.4	26,00	1	004370112
16.4	26,00	1	004370116

Os peças indicados são para 10 unidades

## 437C/RM14

macho para velas de ignição M14x1.25



	€		
437C/RM14	88,00	1	004370124

## 437K/8

kit reparação  
de veios roscados

• Permite rectificar e corrigir a rosca original.

O kit inclui:

• tamanhos métricos:

20x1.25 - 20x1.5 - 22x1.00 - 22x1.5 - 24x1.5 - 24x2.00

• tamanhos polegadas:

3/4x20 - 13/16x20



○ 32 mm

	€		
437K/8	70,50	1	004370020

200x110x30 mm

## 437K/16

jogo de ferramentas para reparação de  
fios danificados em pinças de travão M9x1.25



	€		
437K/16	99,00	1	004370016

210x150x50 mm

## 437K/33

jogo de ferramentas para reparação de  
fios de vela danificados

Casquilhos:

M8x1.0 - M10x1.0 - M10x1.25 - M12x1.25

Derivações:

M8x1.0 - M10x1.0 - M10x1.25 - M12x1.0 - M12x1.25 - M14x1.25



	€		
437K/33	246,00	1	004370133

210x150x50 mm

## 437U/09

Kit para reparação de roscas danificadas  
M5-M6-M8-M10-M12



25 x M5, M6, M8, M10  
10 x M12

	€		
437U/09	299,00	1	004370550

M5X0,8  
M6X1,0  
M8X1,25  
M10X1,5  
M12X1,75

370x230x55 mm - 2 Kg

 **Beta**

## 437U/E-M...

molos helicoidais em aço inoxidável



	H mm	€		
M5	7,5	16,00	1	004370555
M6	9	16,00	1	004370556
M8	12	21,80	1	004370558
M10	15	29,50	1	004370560
M12	18	18,60	1	004370562

Os preços referem-se a 25 unidades (10 para a medida M12)

## 437U/PM

bits e punções para ref. 437U/09



	€		
M5	31,00	1	004370565
M6	32,50	1	004370566
M8	43,00	1	004370568
M10	55,50	1	004370570
M12	69,00	1	004370572

## 438A

jogo de bits, para perfurar, roscar e escarear, HSS

- M3 - M4 - M5 - M6 - M8 - M10
- com porta bits magnético



	€		
438A	102,00	1	004380010

## 438...

bits para furar, roscar e escarear

HSS, encabadouro 1/4"



	S max mm	€		
M3	3	19,70	2	004380103
M4	4	19,70	2	004380104
M5	5	19,70	2	004380105
M6	6	19,70	2	004380106
M8	8	21,80	2	004380108
M10	10	21,80	2	004380110

## 440

caçonetos redondos, passo largo em aço ao cromo



UNI EN 22568

M	Ø mm	€		
2x0,4	25,4	15,30	5	004400002
3x0,5	25,4	11,40	5	004400003
4x0,7	25,4	11,40	5	004400004
5x0,8	25,4	9,75	5	004400005
6x1	25,4	9,75	5	004400006
7x1	25,4	9,75	5	004400007
8x1,25	25,4	9,75	5	004400008
9x1,25	25,4	9,75	5	004400009
10x1,5	25,4	9,75	5	004400010
12x1,75	25,4	9,75	5	004400012

## 440A

caçonetos redondos, passo largo em aço ao cromo



UNI EN 22568

M	Ø mm	€		
10x1,5	38,1	13,70	3	004400110
11x1,5	38,1	13,70	3	004400111
12x1,75	38,1	13,70	3	004400112
14x2	38,1	13,70	3	004400114
16x2	38,1	13,70	3	004400116
18x2,5	38,1	15,90	3	004400118
20x2,5	38,1	17,50	3	004400120

## 440B

caçonetos redondos, passo largo em aço ao cromo



UNI EN 22568

M	Ø mm	€		
18x2,5	50,8	24,60	3	004400122
20x2,5	50,8	25,50	3	004400124
22x2,5	50,8	27,50	3	004400126
24x3	50,8	28,00	3	004400128

## 440ASW

caçonetos redondos rosca Whitworth em aço ao cromo



BSW	Ø mm	€		
1/8x40	25,4	13,00	5	004400201
5/32x32	25,4	13,00	5	004400202
3/16x24	25,4	11,70	5	004400203
1/4x20	25,4	11,70	5	004400204
5/16x18	25,4	11,70	5	004400205
3/8x16	38,1	16,40	3	004400206
7/16x14	38,1	16,40	3	004400207
1/2x12	38,1	16,90	3	004400208
9/16x12	38,1	16,90	3	004400209
5/8x11	50,8	30,00	3	004400210
3/4x10	50,8	30,00	3	004400211
7/8x9	50,8	34,50	3	004400212
1"x8	50,8	34,50	3	004400213

## 440ASC

caçonetos redondos passo largo rosca UNC em aço ao cromo

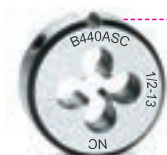

UNC	Ø mm	€		
1/4x20	25,4	11,50	5	004400221
5/16x18	25,4	11,50	5	004400222
3/8x16	38,1	15,90	3	004400223
7/16x14	38,1	15,90	3	004400224
1/2x13	38,1	15,90	3	004400225
9/16x12	38,1	15,90	3	004400226
5/8x11	50,8	34,00	3	004400227
3/4x10	50,8	34,00	3	004400228
7/8x9	50,8	34,00	3	004400229
1"x8	50,8	34,00	3	004400230

## 440ASF

caçonetos redondos passo fino rosca UNF em aço ao cromo

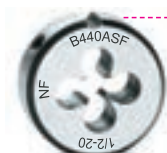

ANSI B1.1

UNF	Ø mm	€		
1/4x28	25,4	12,30	5	004400241
5/16x24	25,4	12,30	5	004400242
3/8x24	38,1	17,40	3	004400243
7/16x20	38,1	17,40	3	004400244
1/2x20	38,1	17,40	3	004400245
9/16x18	38,1	17,40	3	004400246
5/8x18	50,8	35,50	3	004400247
3/4x16	50,8	35,50	3	004400248
7/8x14	50,8	35,50	3	004400249
1"x12	50,8	35,50	3	004400250

## 440ASG

caçonetos redondos rosca GAS cilíndrica em aço ao cromo



UNI EN 22568

GAS	Ø mm	€	🔧	📄
1/8x28	38,1	13,80	3	004400255
1/4x19	38,1	13,80	3	004400256
3/8x19	38,1	13,80	3	004400257
1/2x14	50,8	28,00	3	004400259
3/4x14	50,8	28,00	3	004400260
1"x11	63,5	56,50	3	004400261

## 441

caçonetos redondos, passo fino em aço ao cromo

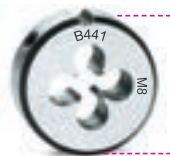

UNI EN 22568

M	Ø mm	€	🔧	📄
6x0,75	25,4	11,50	5	004410004
7x0,75	25,4	11,50	5	004410005
8x0,75	25,4	11,50	5	004410006
8x1	25,4	11,50	5	004410007
9x0,75	25,4	11,50	5	004410008
9x1	25,4	11,50	5	004410009

## 441A

caçonetos redondos, passo fino em aço ao cromo



UNI EN 22568

M	Ø mm	€	🔧	📄
10x0,75	38,1	17,50	3	004410100
10x1	38,1	17,50	3	004410101
10x1,25	38,1	17,50	3	004410102
11x0,75	38,1	17,50	3	004410103
11x1	38,1	17,50	3	004410104
11x1,25	38,1	17,50	3	004410105
12x0,75	38,1	17,50	3	004410106
12x1	38,1	17,50	3	004410107
12x1,25	38,1	17,50	3	004410108
12x1,5	38,1	17,50	3	004410109
14x1	38,1	17,50	3	004410110
14x1,25	38,1	17,50	3	004410111
14x1,5	38,1	17,50	3	004410112
16x1	38,1	17,50	3	004410113
16x1,5	38,1	17,50	3	004410114
18x1,5	38,1	17,50	3	004410115

## 441B

caçonetos redondos, passo fino em aço ao cromo



UNI EN 22568

M	Ø mm	€	🔧	📄
18x1,5	50,8	32,50	3	004410117
18x2	50,8	33,00	3	004410118
20x1,5	50,8	34,00	3	004410119
22x1,5	50,8	34,50	3	004410120
24x1,5	50,8	35,00	3	004410121
24x2	50,8	35,00	3	004410122

## 442

caçonetos redondos, passo largo em HSS



UNI EN 22568

M	ØxS mm	€	🔧	📄
3x0,5	20x5	13,70	3	004420003
4x0,7	20x5	13,70	3	004420004
5x0,8	20x7	13,70	3	004420005
6x1	20x7	13,70	3	004420006
7x1	25x9	15,30	3	004420007
8x1,25	25x9	15,30	3	004420008
10x1,5	30x11	18,00	3	004420010
12x1,75	38x14	29,50	3	004420012
14x2	38x14	37,50	1	004420014
16x2	45x18	48,00	1	004420016
18x2,5	45x18	51,50	1	004420018
20x2,5	45x18	52,50	1	004420020
22x2,5	55x22	73,50	1	004420022
24x3	55x22	75,50	1	004420024

## 443

caçonetos redondos passo fino rosca UNF em aço HSS



UNI EN 22568

M	ØxS mm	€	🔧	📄
6x0,75	20x7	24,00	1	004430107
8x0,75	25x9	26,00	1	004430110
8x1	25x9	25,00	1	004430111
10x0,75	30x11	32,50	1	004430113
10x1	30x11	29,00	1	004430114
10x1,25	30x11	29,00	1	004430115
12x1	38x10	47,00	1	004430116
12x1,25	38x10	47,00	1	004430117
12x1,5	38x10	47,00	1	004430118
13x1,5	38x10	56,50	1	004430119
14x1	38x10	46,50	1	004430120
14x1,25	38x10	46,50	1	004430121
14x1,5	38x10	46,50	1	004430122
15x1,5	38x10	62,50	1	004430123
16x1	45x14	69,00	1	004430124
16x1,5	45x14	69,00	1	004430125

M	ØxS mm	€	🔧	📄
18x1,5	45x14	69,00	1	004430127
20x1,25	45x14	71,00	1	004430129
20x1,5	45x14	71,00	1	004430130
20x2	45x14	74,50	1	004430131
22x1,5	55x16	86,00	1	004430132
24x1	55x16	88,50	1	004430133
24x1,5	55x16	88,50	1	004430135
24x2	55x16	93,00	1	004430136

## 444

porta-caçonetos corpo em aço



DIN 225

	Ø mm	L mm	€	🔧	📄
444	20x5	215	18,90	5	004440005
444/0	20x7	215	18,90	5	004440007
444/1	25,4	225	19,70	5	004440025
444/1A	25x9	225	20,20	5	004440027
444/1B	30x11	300	22,90	5	004440030
444/C	38x10	315	28,50	3	004440033
444/1C	38x14	315	28,50	3	004440035
444/2	38,1x12,7	360	29,50	3	004440038
444/1D	45x14	455	40,50	1	004440045
444/2D	45x18	455	40,50	1	004440046
444/3	50,8x15,9	555	59,00	1	004440050
444/4	55x16	555	59,00	1	004440055
444/5A	63,5x19,7	630	101,50	1	004440057

## 444G

porta-caçonetos corpo em liga leve



UNI EN 22568

	Ø mm	L mm	€	🔧	📄
444G/A	16x5	160	8,95	5	004440103
444G	20x5	200	10,10	5	004440105
444G/0	20x7	200	10,10	5	004440107
444G/1	25,4	210	12,30	5	004440125
444G/1A	25x9	224	12,30	5	004440127
444G/1B	30x11	280	15,30	5	004440130
444G/C	38x10	315	22,40	3	004440133
444G/1C	38x14	315	22,40	3	004440135
444G/2	38,1x12,6	320	22,40	3	004440138
444G/1D	45x14	450	30,00	1	004440145
444G/2D	45x18	450	31,50	1	004440146
444G/3	50,8x16	500	32,00	1	004440150
444G/4	55x16	560	38,50	1	004440155
444G/5A	63,5x19	620	68,00	1	004440163
444G/6	65x18	630	71,00	1	004440165





## 446/C30

jogo de machos e caçonetos em aço ao cromo e acessórios rosca métrica em caixa de madeira



446/C30 € 278,00 1 004460055

500x337x60 mm - 8,1 Kg

430 M	440 M	435/1,5	444/1
3x0,5	3x0,5		
4x0,7	4x0,7		
5x0,8	5x0,8		
6x1	6x1		
8x1,25	8x1,25		
10x1,5	10x1,5		
12x1,75	12x1,75		

## 446/C48

jogo de machos e caçonetos em aço ao cromo e acessórios rosca métrica em caixa de madeira



446/C48 € 527,00 1 004460057

580x300x50 mm - 5 Kg

430 M	440 M	440A M	435/1	444/1
3x0,5	3x0,5	10x1,5	435/1	444/1
4x0,7	4x0,7	12x1,75	435/3	444/2
5x0,8	5x0,8	14x2		
6x1	6x1	16x2		
8x1,25	8x1,25	18x2,5		
10x1,5		20x2,5		
12x1,75				
14x2				
16x2				
18x2,5				
20x2,5				

## 446/C110

jogo de machos e caçonetos em aço ao cromo e acessórios rosca métrica em caixa de madeira



446/C110 € 774,00 1 004460060

500x337x60 mm - 8,1 Kg

430 M	433 M	440/440A, 441/441A, M	441A, M
2x0,4	6x0,75	2x0,4	6x0,75
3x0,5	7x0,75	3x0,5	7x0,75
4x0,7	8x0,75	4x0,7	8x0,75
5x0,8	8x1	5x0,8	8x1
6x1	9x0,75	6x1	9x0,75
7x1	9x1	7x1	9x1
8x1,25	10x0,75	8x1,25	10x0,75
9x1,25	10x1	9x1,25	10x1
10x1,5	10x1,25	10x1,5	10x1,25
11x1,5	11x0,75	11x1,5	11x0,75
12x1,75	11x1	12x1,75	11x1
14x2	11x1,25	14x2	11x1,25
16x2	12x0,75	16x2	12x0,75
	12x1		12x1
	12x1,25		12x1,25
	12x1,5		12x1,5
	14x1		14x1
	14x1,25		14x1,25
	14x1,5		14x1,5
	16x1		16x1
	16x1,5		16x1,5
	18x1,5		18x1,5

435/0	444/1	436/1
435/3	444/2	

## 446ASF/C29

jogo de machos e caçonetos em aço ao cromo e acessórios rosca UNF em caixa de madeira



446ASF/C29 € 602,00 1 004460070

660x410x50 mm - 6 Kg

433ASF	440ASF	435/1,5	444/1
1/4	1/4	435/1,5	444/1
5/16	5/16	435/3	444/2
3/8	3/8		444/3
7/16	7/16		
1/2	1/2		
9/16	9/16		
5/8	5/8		
3/4	3/4		

## 446ASW/C36

jogo de machos e caçonetos em aço ao cromo e acessórios rosca Whitworth em caixa de madeira



446ASW/C36 € 453,00 1 004460075

525x310x50 mm - 3,4 Kg

430ASW	440ASW	435/1,5	444/1
1/8	1/8	435/1,5	444/1
5/32	5/32	435/2	444/2
3/16	3/16		
1/4	1/4		
5/16	5/16		
3/8	3/8		
7/16	7/16		
1/2	1/2		

## 446ASC/C37

jogo de machos e caçonetos em aço ao crómio e acessórios rosca **UNC** em caixa de madeira



446ASC/C37 € 646,00 1 004460080

≡ 660x410x50 mm - 6,7 Kg

430ASC	440ASC		
1/4	1/4	435/1,5	444/1
5/16	5/16	435/3	444/2
3/8	3/8		444/3
7/16	7/16		
1/2	1/2		
9/16	9/16		
5/8	5/8		
3/4	3/4		

## 446ASG/C23

jogo de machos e caçonetos em aço ao crómio e acessórios rosca **GAS** cilíndrica em caixa de madeira



446ASG/C23 € 946,00 1 004460085

≡ 700x430x70 mm - 9,8 Kg

433ASG	440ASG		
1/8	1/8	435/3	444/2
1/4	1/4	435/5	444/3
3/8	3/8		444/5A
1/2	1/2		
3/4	3/4		
1"	1"		

## 447/C37

jogo de machos e caçonetos em HSS e acessórios rosca métrica em caixa de metálica



447/C37 € 566,00 1 004470055

≡ 380x185x35 mm - 3,9 Kg

431 M	442 M		
3x0,5	3x0,5	435/0	444
4x0,7	4x0,7	435/2	444/0
5x0,8	5x0,8		444/1A
6x1	6x1		444/1B
8x1,25	8x1,25		444/1C
10x1,5	10x1,5		
12x1,75	12x1,75		

436/1	0,5x3x75
-------	----------

## 447/C53

jogo de machos e caçonetos em HSS e acessórios rosca métrica em caixa de metálica



447/C53 € 1.178,00 1 004470060

≡ 500x235x50 mm - 9 Kg

431 M	442 M			
3x0,5	3x0,5	435/1,5	444	436/1
4x0,7	4x0,7	435/3	444/0	436/2
5x0,8	5x0,8		444/1A	
6x1	6x1		444/1B	
8x1,25	8x1,25		444/1C	
10x1,5	10x1,5		444/2D	
12x1,75	12x1,75			
14x2	14x2			
16x2	16x2			
18x2,5	18x2,5			
20x2,5	20x2,5			

## 447/C70

jogo de machos e caçonetos em HSS e acessórios rosca métrica em caixa de madeira



447/C70 € 1.455,00 1 004470065

≡ 510x340x70 mm - 7,5 Kg

431 M	434 M	442 M	443 M
3x0,5	8x1	3x0,5	8x1
4x0,7	10x1,25	4x0,7	10x1,25
5x0,8	12x1,25	5x0,8	12x1,25
6x1	12x1,5	6x1	12x1,5
7x1	14x1,25	7x1	14x1,25
8x1,25	14x1,5	8x1,25	14x1,5
10x1,5	16x1,5	10x1,5	16x1,5
12x1,75		12x1,75	
14x2		14x2	
16x2		16x2	

435/0	444	436/1
435/3	444/0	
	444/1A	
	444/1B	
	444/1C	
	444/1D	

## 450

brocas cranianas em HSS bi-metal

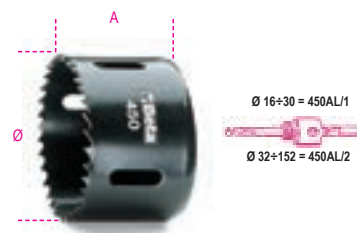

HSS-Co 8%

Ø mm	Ø	A mm	€		
16	(5/8)	57	15,30	1	004500016
17	(11/16)	57	15,30	1	004500017
19	(3/4)	51	15,30	1	004500019
20	-	51	15,30	1	004500020
21	(13/16)	51	15,30	1	004500021
22	(7/8)	51	15,30	1	004500022
24	(15/16)	51	15,30	1	004500024
25	(1")	51	16,10	1	004500025
27	(1 1/16)	51	16,40	1	004500027
29	(1 1/8)	51	16,40	1	004500029
30	(1 3/16)	51	16,40	1	004500030
32	(1 1/4)	51	16,90	1	004500032
33	(1 5/16)	51	16,90	1	004500033
35	(1 3/8)	51	19,30	1	004500035
37	(1 7/16)	51	19,30	1	004500037
38	(1 1/2)	44	19,70	1	004500038

Ø mm	Ø "	A mm	€		
40	(1"9/16)	44	20,20	1	004500040
41	(1"5/8)	44	20,80	1	004500041
43	(1"11/16)	44	20,80	1	004500043
44	(1"3/4)	44	22,10	1	004500044
46	(1"13/16)	44	22,10	1	004500046
48	(1"7/8)	44	22,60	1	004500048
51	(2")	44	22,90	1	004500051
52	(2"1/16)	44	26,00	1	004500052
54	(2"1/8)	44	26,00	1	004500054
57	(2"1/4)	44	26,00	1	004500057
59	(2"5/16)	44	27,00	1	004500059
60	(2"3/8)	44	27,00	1	004500060
64	(2"1/2)	44	28,50	1	004500064
65	(2"9/16)	44	28,50	1	004500065
67	(2"5/8)	44	28,50	1	004500067
68	-	44	28,50	1	004500068
70	(2"3/4)	44	29,00	1	004500070
73	(2"7/8)	44	29,00	1	004500073
76	(3")	44	30,00	1	004500076
79	(3"1/8)	44	31,00	1	004500079
83	(3"1/4)	44	32,00	1	004500083
86	(3"3/8)	44	33,00	1	004500086
89	(3"1/2)	44	34,00	1	004500089
92	(3"5/8)	44	35,50	1	004500092
95	(3"3/4)	44	38,50	1	004500095
98	(3"7/8)	44	39,50	1	004500098
102	(4")	44	40,50	1	004500102
105	(4"1/8)	44	44,00	1	004500105
108	(4"1/4)	44	57,00	1	004500108
111	(4"3/8)	44	65,00	1	004500111
114	(4"1/2)	44	76,50	1	004500114
121	(4"3/4)	44	84,50	1	004500121
127	(5")	44	93,50	1	004500127
140	(5"1/2)	44	113,00	1	004500140
152	(6")	44	131,00	1	004500152

## 450AL

buchas para brocas cranianas

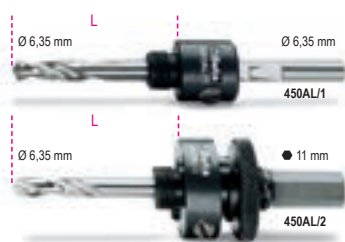

	Ø mm	L mm	€		
450AL/1	16÷30	54	18,00	1	004500210
450AL/2	32÷152	70	43,50	1	004500215

## 450AD

adaptador bucha/broca craniana 450AL/1



	Ø mm	€		
450AD	32÷51	7,10	1	004500230

## 450PA/1

brocas para buchas em HSS para 450AL/1



ØxL mm	€		
6,35x105	10,90	1	004500252

## 450PA/2

brocas para buchas em HSS para 450AL/2



ØxL mm	€		
6,35x80	10,90	1	004500253

## 450PR

extensão para brocas cranianas



L mm	€		
305	31,50	1	004500255

## 450/C9

jogo de brocas cranianas e acessórios para electricista



HSS-Co 8%

	€		
450/C9	218,00	1	004500305

450 Ø 22 - 29 - 35 - 44 - 51 - 64 mm

450AL /1 - /2

450AD

220x160x60 mm - 1,6 Kg

## 450/C13

jogo de brocas cranianas e acessórios para instaladores



HSS-Co 8%

	€		
450/C13	273,00	1	004500310

450 Ø 19 - 22 - 29 - 35 - 38

44 - 51 - 57 - 64 mm

450AL /1 - /2

450PA/1

450AD

215x180x65 mm - 1,8 Kg

## 450/C15

Sortido de serras e acessórios para eléctricos



	€		
450/C15	349,00	1	004500313

450 Ø 16 - 20 - 25 - 32 - 40

51 - 60 - 65 - 70 mm

450AL /1 - /2

450PA /1 - /2

450PR

450AD

420x185x60 mm - 3,2 Kg

 Beta

 Beta

## 450/C21

jogo de brocas cranianas e acessórios para uso industrial



HSS-Co 8%

450/C21	€ 610,00	1	004500315
---------	----------	---	-----------

450	Ø 19 - 22 - 29 - 35 - 38 44 - 51 - 57 - 64 - 76 83 - 92 - 95 - 105 - 114 mm
450AL	/1 - /2
450PA	/1 - /2
450PR	
450AD	

420x280x60 mm - 7 Kg

## 451

fresa craniana em HSS inteiramente rectificado

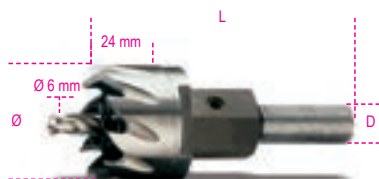

Ø mm	L mm	D mm	€	1	004510012
12	85	8	21,80	1	004510012
13	85	8	21,80	1	004510013
14	85	8	22,40	1	004510014
15	85	10	22,40	1	004510015
16	85	10	22,40	1	004510016
17	85	10	22,40	1	004510017
18	85	10	22,40	1	004510018
19	85	10	22,90	1	004510019
20	85	10	24,00	1	004510020
21	85	10	25,50	1	004510021
22	85	10	27,00	1	004510022
23	85	10	28,50	1	004510023
24	85	10	29,50	1	004510024
25	85	10	31,00	1	004510025
26	90	10	32,00	1	004510026
27	90	10	33,00	1	004510027
28	90	10	33,50	1	004510028
29	90	10	34,50	1	004510029
30	90	10	35,00	1	004510030
31	90	10	37,00	1	004510031
32	90	10	38,00	1	004510032
33	90	10	39,50	1	004510033
34	90	10	40,50	1	004510034
35	90	10	41,50	1	004510035
36	85	10	43,00	1	004510036
37	85	10	44,00	1	004510037
38	85	10	45,00	1	004510038
39	85	10	46,50	1	004510039
40	85	10	47,50	1	004510040
41	85	10	49,50	1	004510041
42	85	10	51,00	1	004510042
43	85	10	52,00	1	004510043
44	85	10	53,00	1	004510044
45	85	10	54,50	1	004510045
46	85	10	55,50	1	004510046
47	85	10	57,00	1	004510047
48	85	10	59,00	1	004510048
49	85	10	61,50	1	004510049
50	85	10	61,50	1	004510050

## 451GA

bucha para fresa craniana artigo 451



M	Ø mm	L mm	D mm	€	1	004510101
10x1,25	12÷14	57	8	12,60	1	004510101
12x1,25	15÷34	57	10	12,60	1	004510102
14x1,5	35÷50	57	10	15,30	1	004510105

## 451PA

brocas para buchas 451 em HSS



Ø mm	L mm	€	1	004510103
6	53	7,10	1	004510103

## 451PR

extensão para fresa craniana artigo 451



M	Ø mm	L mm	Ø1 mm	€	1	004510104
12x1,25	15÷34	400	13	56,00	1	004510104
14x1,5	35÷50	400	13	56,00	1	004510108

## 452

fresa craniana com insertos em metal duro

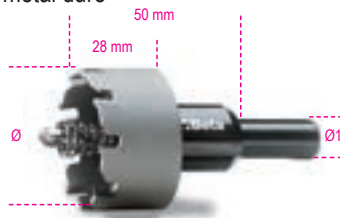

Ø mm	Ø1 mm	€	1	004520015
15	10	92,50	1	004520015
16	10	92,50	1	004520016
17	10	92,50	1	004520017
18	10	92,50	1	004520018
19	10	92,50	1	004520019
20	10	92,50	1	004520020
21	10	92,50	1	004520021
22	10	92,50	1	004520022
23	10	92,50	1	004520023
24	10	92,50	1	004520024
25	10	92,50	1	004520025
26	10	104,00	1	004520026
27	10	104,00	1	004520027
28	10	104,00	1	004520028
29	10	104,00	1	004520029
30	10	104,00	1	004520030
31	10	125,00	1	004520031
32	10	125,00	1	004520032
33	10	125,00	1	004520033
34	10	125,00	1	004520034
35	10	125,00	1	004520035
36	10	145,00	1	004520036
37	10	145,00	1	004520037
38	10	145,00	1	004520038
39	13	145,00	1	004520039
40	13	145,00	1	004520040

Ø mm	Ø1 mm	€	1	004520041
41	13	163,00	1	004520041
42	13	163,00	1	004520042
43	13	163,00	1	004520043
44	13	163,00	1	004520044
45	13	163,00	1	004520045
46	13	184,00	1	004520046
47	13	184,00	1	004520047
48	13	184,00	1	004520048
49	13	184,00	1	004520049
50	13	184,00	1	004520050
55	13	207,00	1	004520055
60	13	273,00	1	004520060
65	13	273,00	1	004520065
70	13	321,00	1	004520070
75	13	344,00	1	004520075
80	13	371,00	1	004520080
85	13	426,00	1	004520085
90	13	455,00	1	004520090

## 452GA

bucha para fresa craniana 452



Ø mm	€	1	004520125	
452GA/1	15÷21	11,50	1	004520125
452GA/2	22÷38	13,10	1	004520126
452GA/3	39÷100	15,30	1	004520127

## 560/C2

multiplicador de binário com acessórios relação 5:1 em caixa plástica

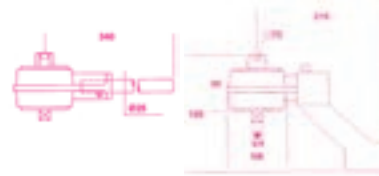

Nm	Kgfm	lbf.ft	□	■	kg
1300	130	960	1/2	3/4	3,8

	€	1	005600020
560/C2	1.565,00	1	005600020
560/2	1.167,00	1	005600002
560/18	35,50	1	005600018
560/19	77,50	1	005600019
560/22	270,00	1	005600022

310x275x120 mm

**Beta**

## 560/C4+

Multiplicador de binário,  
relação 5:1, com efeito bloqueio



Nm	Kgfm	lbf.ft	□	■	kg
2700	270	2000	3/4"	1"	5

	€	🔧	📦
560/C4PLUS	1.535,00	1	005600042
560/4	1.210,00	1	005600004
560/18	35,50	1	005600018
560/22	270,00	1	005600022

≡ 310x275x120 mm

## 560/C6

Multiplicador de binário para aperto a esquerda e a direita em caixa plástica  
Relação: 6.5:1



Nm	Kgfm	lbf.ft	□	■	kg
1500	150	1106	1/2"	3/4"	6

	€	🔧	📦
560/C6	796,00	1	005600160

≡ 400x260x110 mm

## 560/C12

Multiplicador de binário para aperto a esquerda e a direita em caixa plástica  
Relação: 12:1



Nm	Kgfm	lbf.ft	□	■	kg
2500	250	1844	1/2"	1"	7

	€	🔧	📦
560/C12	1.156,00	1	005600210

≡ 400x260x110 mm

## 561/1

multiplicador de binário,  
relação 5:1 com duas uniões de reação

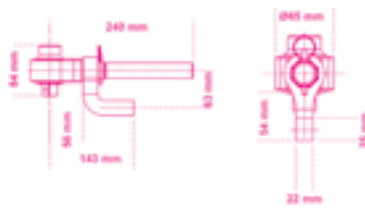

Nm	Kgfm	lbf.ft	□	■	kg
1000	100	740	1/2"	3/4"	2,7

	€	🔧	📦
561/1	1.101,00	1	005610010

≡ 270x210x70 mm

## 562/1 - 562/2

multiplicadores de binário relação 5:1

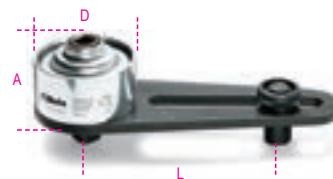

Nm	Kgfm	lbf.ft	□	■	D	A	L min	L max	kg
1700	170	1250	3/4"	1"	108	95	85	220	5,3

	€	🔧	📦
562/1	2.440,00	1	005620001

Nm	Kgfm	lbf.ft	□	■	D	A	L min	L max	kg
3400	340	2500	3/4"	1"	119	115	85	265	7,0

	€	🔧	📦
562/2	3.000,00	1	005620002

## 564/3R - 564/4R

multiplicadores de binário  
com pé de apoio relação 25:1  
com sistema anti-retorno



Nm	Kgfm	lbf.ft	□	■	D	A	L	kg
3000	300	2200	1/2"	1"	108	188	155	9,2

	€	🔧	📦
564/3R	4.950,00	1	005640003

Nm	Kgfm	lbf.ft	□	■	D	A	L	kg
6000	600	4500	1/2"	1 1/2"	119	235	200	15,5

	€	🔧	📦
564/4R	5.890,00	1	005640004

## 565/1R - 565/2R - 565/3R

multiplicadores de binário relação 25:1  
com sistema anti-retorno



Nm	Kgfm	lbf.ft	□	■	D	A	L min	L max	kg
1700	170	1250	1/2"	1"	108	125	80	215	7,7

	€	🔧	📦
565/1R	4.070,00	1	005650011

Nm	Kgfm	lbf.ft	□	■	D	A	L min	L max	kg
3400	340	2500	1/2"	1"	119	145	85	265	10,1

	€	🔧	📦
565/2R	5.350,00	1	005650012

Nm	Kgfm	lbf.ft	□	■	D	A	L min	L max	kg
3400	340	2500	1/2"	1 1/2"	119	145	85	265	10,7

	€	🔧	📦
565/3R	5.670,00	1	005650013

## 565/4R

multiplicadores de binário **relação 25:1**  
com sistema anti-retorno

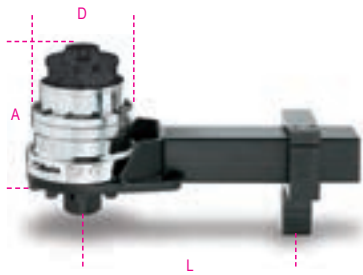

Nm	Kgfm	lbf.ft	□	■	D	A	L min	L max	📏
6000	600	4500	1/2	1 1/2	144	180	125	335	17

565/4R € 6.350,00 1 005650014

## 565/5R

multiplicadores de binário **relação 25:1**  
com sistema anti-retorno

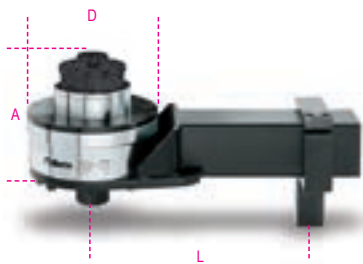

Nm	Kgfm	lbf.ft	□	■	D	A	L min	L max	📏
9500	950	7000	3/4	1 1/2	184	180	155	355	25

565/5R € 11.100,00 1 005650015

## 567/4R

multiplicadores de binário **relação 125:1**  
com sistema anti-retorno

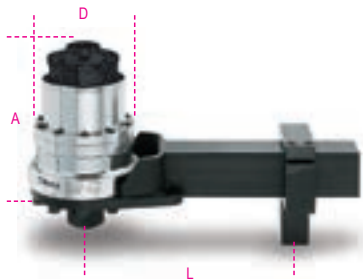

Nm	Kgfm	lbf.ft	□	■	D	A	L min	L max	📏
6000	600	4500	1/2	1 1/2	144	210	125	335	19

567/4R € 7.120,00 1 005670014

## 567/5R

multiplicadores de binário **relação 125:1**  
com sistema anti-retorno

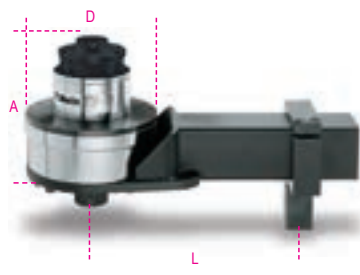

Nm	Kgfm	lbf.ft	□	■	D	A	L min	L max	📏
9500	950	7000	1/2	1 1/2	184	210	155	350	27

567/5R € 12.510,00 1 005670015

## 581

aparafusadora dinâmétrica não graduada  
para apertos à direita  
precisão:  $\pm 6\%$   
(para utilização com artigos 588 - 682)



UNI EN ISO 6789

Nm	gfm	○	📏
1,2÷6	120÷600	1/4"	275

581 € 249,00 1 005810001

## 583

aparafusadora dinâmétrica graduada  
para apertos à direita  
precisão:  $\pm 6\%$



UNI EN ISO 6789

Nm	gfm	○	📏
0,3÷1,5	30÷150	1/4"	240

583/1,5 € 280,00 1 005830015

Nm	gfm	○	📏
0,6÷3	60÷300	1/4"	240

583/3 € 280,00 1 005830030

Nm	gfm	○	📏
1,2÷6	120÷600	1/4"	350

583/6 € 280,00 1 005830060

## 583/C31

1 aparafusadora dinâmétrica, 8 chaves de caixa manuais sextavadas, 20 bits e 2 acessórios



583/C31 € 389,00 1 005830931

583/6	1.2 - 6 Nm
900	4-5-5,5-6-7-8-9-10 mm
860LP	0,6x4,5 - 1x5,5 - 1,2x6,5 mm
860PH	PH1 - PH2 (x2) - PH3
860PE	2-2,5-3-4-5 mm
860TX	T9-T10-T15-T20-T25-T27-T30-T40
882P/80	80 mm
892/0	● 1/4 ■ 1/4

270x120x45 mm - 📏 1,2 kg

## 588

medidor de binário electrónico

para testar e calibrar aparafusadoras dinâmétricas 581-583  
Precisão:  $\pm 1\%$



Nm	lbf.in	□	📏
1÷10	10÷90	1/4"	1,8

588 € 1.885,00 1 005880001

## 590 - 592

chaves dinâmétricas de leitura directa  
para aperto direito e esquerdo  
precisão:  $\pm 4\%$



UNI EN ISO 6789

Nm	Kgfm	lbf.in	■	A	L	📏
0,3÷4	0,03÷0,4	3÷35	1/4	60	253	0,52

590 € 665,00 1 005900001

Nm	Kgfm	lbf.in	■	A	L	📏
0,5÷13,5	0,05÷1,35	4÷120	1/4	60	253	0,52

590/1 € 665,00 1 005900003

## 599DGT-AN

chave dinamométrica eletrônica, leitura do binário e ângulo, com roquete reversível, para aperto à direita (precisão:  $\pm 2\%$ ) e à esquerda (precisão:  $\pm 3\%$ )

- tipos de aperto: binário, ângulo, binário + ângulo
- modo de medição duplo: pico e curso
- indicador luminoso e sinal acústico informam o utilizador que o valor pré-seleccionado foi atingido
- armazenamento de dados (até 250 valores)
- predefinição até 9 valores binário/ângulo
- bloqueio de segurança
- permite inserir 16 utilizadores diferentes através da ID de utilizador
- rastreabilidade de dados. O software permite armazenar e associar à ID de utilizador a data e hora, número de série da ferramenta, valor de aperto definido e valor alcançado
- punho de dois componentes antiderrapante
- inclui: 2 pilhas AA - 1.5V, cabo USB e software



12"

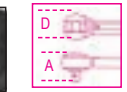

UNI EN 26789  
ISO 6789

Nm	Kgfm	lbf.ft	D	A	L	kg	
20÷100	2÷10	15÷80	1/2	30	33	413	0,9

599DGT-AN/10 € 649,00 1 005990610

Nm	Kgfm	lbf.ft	D	A	L	kg	
40÷200	4÷20	30÷150	1/2	40	43	520	1,3

599DGT-AN/20 € 687,00 1 005990620

Serviço de calibração de binário no final



Nm	Kgfm	lbf.in	A	L	kg	
1÷27	0,1÷2,7	10÷240	3/8	70	253	0,52

592/3 € 662,00 1 005920005

Nm	Kgfm	lbf.in	A	L	kg	
3÷40	0,3÷4	20÷360	3/8	70	253	0,52

592/4 € 662,00 1 005920007

Tabela de campos de aplicação de chaves e barras dinamométricas no final

## 594

chaves dinamométricas de leitura directa para aperto direito e esquerdo precisão:  $\pm 4\%$

12"



UNI EN ISO 6789

Nm	Kgfm	lbf.ft	A	L	kg	
6÷80	0,6÷8	5÷60	1/2	85	455	1,35

594/8 € 996,00 1 005940011

Nm	Kgfm	lbf.ft	A	L	kg	
20÷215	2÷21,5	15÷160	1/2	85	530	1,40

594/21 € 996,00 1 005940015

## 596 - 598

chaves dinamométricas de leitura directa para aperto direito e esquerdo precisão:  $\pm 4\%$

Com avisadores luminosos e sonoros na medida pré-definida



UNI EN ISO 6789

Nm	Kgfm	lbf.ft	A	L	kg	
80÷400	8÷40	60÷300	3/4	111	710	3,2

596/40SL € 1.665,00 1 005960010

Nm	Kgfm	lbf.ft	A	L	kg	
160÷800	16÷80	120÷600	3/4"	115	1025	4,85

596/80SL € 2.100,00 1 005960020

Nm	Kgfm	lbf.ft	A	L	kg	
200÷2000	20÷200	150÷1500	1"	135	1930	16,70

598/200SL € 4.360,00 1 005980022

Serviço de calibração de binário no final

## 599DGT

chave eletrônica com roquete reversível, aperto à direita (precisão:  $\pm 2\%$ ) e à esquerda (precisão:  $\pm 3\%$ )

- Modo de medição dupla: pico e curso
- Indicadores luminosos e acústicos informam o utilizador que o valor pré-seleccionado foi atingido
- Alimentação: 2 pilhas 1.5V (incluídas)



12"



UNI EN ISO 6789

Nm	Kgfm	lbf.ft	D	A	L	kg	
12÷60	1,2÷6	8÷44	3/8	30	33	413	0,9

599DGT/6 € 348,00 1 005990003

Nm	Kgfm	lbf.ft	D	A	L	kg	
20÷100	2÷10	15÷80	1/2	30	37	413	0,9

599DGT/10X € 359,00 1 005990010

Nm	Kgfm	lbf.ft	D	A	L	kg	
40÷200	4÷20	30÷150	1/2	40	43	520	2

599DGT/20 € 374,00 1 005990020

Nm	Kgfm	lbf.ft	D	A	L	kg	
68÷340	6,8÷34	58÷280	1/2	40	43	640	2,35

599DGT/30 € 403,00 1 005990030

## 600

chaves de aperto angular

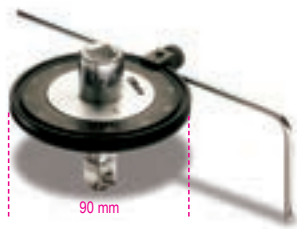

	□	■	€	🔧	📦
600/1	1/2	1/2	140,00	1	006000001
600/2	3/4	3/4	157,00	1	006000002

## 601C

indicador digital ângulo de aperto

Indicador luminoso e um sinal sonoro informam o utilizador que o ângulo programado já foi alcançado

CE



	€	🔧	📦
601C	188,00	1	006010100

85x80x87 mm - 70 g

## 601CA

indicador digital ângulo e binário de aperto

Indicador luminoso e um sinal sonoro informam o utilizador que o ângulo programado já foi alcançado

12"

CE



	□	■	Nm	€	🔧	📦
601CA	1/2"	1/2"	10÷200	336,00	1	006010120

120x90x120 mm - 240 g

## 603

chaves dinamométricas com embraiagem de segurança para aperto à direita precisão: ±6%

1/4"



UNI EN ISO 6789

Nm	Kgfm	lbf.in	■	A mm	L mm	g
1÷5	0,1÷0,5	10÷45	1/4	35	195	235

	€	🔧	📦
603/5	567,00	1	006030005

Nm	Kgfm	lbf.in	■	A mm	L mm	g
2÷10	0,2÷1,0	18÷90	1/4	35	195	235

	€	🔧	📦
603/10	578,00	1	006030010

## 604B

barra dinamométrica para aperto à direita e à esquerda precisão de aperto: ± 6%



UNI EN ISO 6789

Nm	kgfm	lbf.in	∅ mm	L mm	g
1÷5	0,1÷0,5	10÷45	8	220	290

	€	🔧	📦
604B/5	368,00	1	006040015

Nm	Kgfm	lbf.in	∅ mm	L mm	g
2÷10	0,2÷1,0	18÷90	8	220	300

	€	🔧	📦
604B/10	368,00	1	006040020

## 605E

chaves dinamométricas com desarme sonoro, roquete reversível de aperto à direita e à esquerda precisão: ± 6%

1/4"



UNI EN ISO 6789

Nm	Kgfm	lbf.in	■	A mm	L mm	g
1÷5	0,1÷0,5	10÷45	1/4	20	190	180

	€	🔧	📦
605E/5	187,00	1	006050105

Nm	Kgfm	lbf.in	■	A mm	L mm	g
2÷10	0,2÷1,0	18÷90	1/4	20	190	180

	€	🔧	📦
605E/10	197,00	1	006050110

## 611

roquete reversível para barras dinamométricas refs. 604B/5 e 604B/10 encabadouro 8 mm

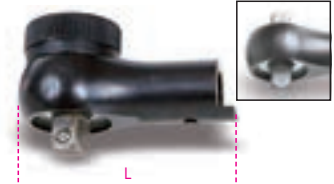

■	L mm	€	🔧	📦
1/4	42,5	131,00	1	006110001

Serviço de calibração de binário no final

## 612 ÷ 614

roquetes reversíveis para barras dinamométricas



As referências 612 e 612X não podem ser usados em apertos cujo torque exceda 100 Nm

	■	L mm	LA mm	€	🔧	📦
612	3/8	66	32	59,00	2	006120000
612X	1/2	66	32	63,50	2	006120010
614	1/2	71	32	68,50	2	006140000
614X	3/4	71	32	76,50	2	006140004

## 614/50

roquete simples para barras dinamométricas



	■	L mm	LA mm	€	🔧	📦
614/50	1/2	71	32	63,00	2	006140002

Ver quadro depois do artigo 929/C8 para acessórios compatíveis usados

# Beta



## 615

roquete reversível  
para barras dinamométricas,  
encabadouro rectangular



mm	mm	L mm	LA mm	€		
9x12	3/8	53	28,8	50,00	1	006150010
9x12	1/2	53	28,8	50,00	1	006150020
14x18	1/2	70	39,8	50,00	1	006150120

## 616 - 617 - 619

quadras macho para barras  
dinamométricas



	mm	L mm	LA mm	€		
616	1/4	61	32	47,50	1	006160000
617	3/8	61	32	47,50	1	006170000
619	1/2	63	32	47,50	1	006190000

## 621

calha porta ponteiras  
para barras dinamométricas,  
encabadouro rectangular



	mm	mm	L mm	LA mm	€		
P1/4	9x12	1/4	40	28,8	57,50	1	006210000
* P5/16	14x18	5/16	61	32,5	87,00	1	006210110

\*Atenção! Recalcular o valor do binário conforme  
indicado na tabela que se encontra no fim do catálogo

## 641

ponteira de boca  
para barras dinamométricas refs. 604B/5 e  
604B/10  
encabadouro 8 mm



mm	L mm	€		
4	37	72,00	1	006410003
5	37	72,00	1	006410004
5,5	37	72,00	1	006410005
6	37	72,00	1	006410006
7	37	72,00	1	006410007
8	42	72,00	1	006410008
9	42	72,00	1	006410009
10	42	72,00	1	006410010

# Beta

## 642

ponteiras boca para barras  
dinamométricas

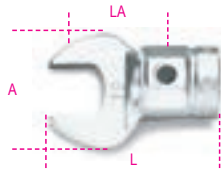

mm	L mm	LA mm	A mm	€		
8	54	32	22	50,00	1	006420008
10	57	32	26	50,00	1	006420010
12	58	32	30	50,00	1	006420012
13	58	32	30	50,00	1	006420013
14	59	32	32	50,00	1	006420014
15	59	32	35	50,00	1	006420015
16	59	32	38	50,00	1	006420016
17	60	32	39	50,00	1	006420017
18	61	32	42	50,00	1	006420018
19	61	32	43	50,00	1	006420019
20	61	32	50	76,50	1	006420020
21	62	32	53	76,50	1	006420021
22	62	32	53	80,00	1	006420022
23	65	32	53	80,00	1	006420023
24	63	32	53	80,00	1	006420024
26	64	32	59	96,00	1	006420026
27	65	32	59	96,00	1	006420027
28	66	32	64	96,00	1	006420028
30	66	32	66	96,00	1	006420030
32	67	32	66	96,00	1	006420032
* 36	76	42	80	144,00	1	006420036
40	77	52	95	144,00	1	006420040
* 41	78	52	95	144,00	1	006420041
* 46	90	52	95	175,00	1	006420046

\*Atenção! Recalcular o valor do binário conforme  
indicado na tabela que se encontra no fim do catálogo

## 643

ponteiras de boca  
para barras de aperto,  
encabadouro rectangular



mm	mm	L mm	LA mm	€		
8	9x12	37	28,8	45,00	1	006430008
10	9x12	39	28,8	45,00	1	006430010
12	9x12	39	28,8	45,00	1	006430012
13	9x12	39	28,8	45,00	1	006430013
14	9x12	43	28,8	45,50	1	006430014
15	9x12	43	28,8	45,50	1	006430015
16	9x12	43	28,8	45,50	1	006430016
17	9x12	43	28,8	45,50	1	006430017
* 18	9x12	47	36,3	45,50	1	006430018
* 19	9x12	51	36,3	45,50	1	006430019
* 22	9x12	52	36,3	71,00	1	006430022

\*Atenção! Recalcular o valor do binário conforme  
indicado na tabela que se encontra no fim do catálogo

mm	mm	L mm	LA mm	€		
13	14x18	60	39,8	47,50	1	006430113
14	14x18	58	39,8	47,50	1	006430114
15	14x18	60	39,8	47,50	1	006430115
16	14x18	60	39,8	48,00	1	006430116
17	14x18	60	39,8	48,00	1	006430117
18	14x18	61	39,8	48,00	1	006430118
19	14x18	61	39,8	48,00	1	006430119
21	14x18	61	39,8	75,50	1	006430121
22	14x18	62	39,8	75,50	1	006430122
24	14x18	64	39,8	75,50	1	006430124
* 27	14x18	68	44,8	85,50	1	006430127
* 30	14x18	77	49,8	86,50	1	006430130
* 32	14x18	77	49,8	86,50	1	006430132
* 34	14x18	80	54,8	137,00	1	006430134
* 36	14x18	83	54,8	137,00	1	006430136
* 41	14x18	91	64,8	137,00	1	006430141

\*Atenção! Recalcular o valor do binário conforme  
indicado na tabela que se encontra no fim do catálogo

## 652

ponteiras de luneta para barras  
dinamométricas

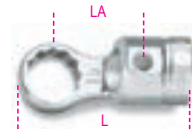

mm	L mm	LA mm	€		
8	58	32	53,50	1	006520008
10	58	32	53,50	1	006520010
12	58	32	53,50	1	006520012
13	58	32	53,50	1	006520013
14	58	32	53,50	1	006520014
15	62	32	53,50	1	006520015
16	63	32	53,50	1	006520016
17	64	32	53,50	1	006520017
18	65	32	53,50	1	006520018
19	65	32	53,50	1	006520019
21	67	32	82,00	1	006520021
22	68	32	82,00	1	006520022
24	69	32	102,50	1	006520024
26	71	32	104,00	1	006520026
27	71	32	104,00	1	006520027
30	73	32	104,00	1	006520030
32	74	32	104,00	1	006520032

\*Atenção! Recalcular o valor do binário conforme  
indicado na tabela que se encontra no fim do catálogo

## 653

ponteiras de luneta  
para barras de aperto,  
encabadouro rectangular



mm	mm	L mm	LA mm	€		
8	9x12	40	28,8	49,00	1	006530008
10	9x12	43	28,8	49,00	1	006530010
12	9x12	44	28,8	49,00	1	006530012
13	9x12	44	28,8	49,00	1	006530013
14	9x12	45	28,8	49,00	1	006530014
15	9x12	46	28,8	49,00	1	006530015
16	9x12	47	28,8	49,50	1	006530016
17	9x12	47	28,8	49,50	1	006530017
18	9x12	48	28,8	49,50	1	006530018
19	9x12	49	28,8	49,50	1	006530019
* 22	9x12	51	28,8	50,50	1	006530022

\*Atenção! Recalcular o valor do binário conforme  
indicado na tabela que se encontra no fim do catálogo

mm	mm	L mm	LA mm	€		
13	14x18	61	39,8	52,50	1	006530113
14	14x18	61	39,8	52,50	1	006530114
15	14x18	62	39,8	52,50	1	006530115
16	14x18	63	39,8	53,00	1	006530116
17	14x18	64	39,8	53,00	1	006530117
18	14x18	64	39,8	53,00	1	006530118
19	14x18	66	39,8	53,00	1	006530119
21	14x18	66	39,8	78,50	1	006530121
22	14x18	67	39,8	78,50	1	006530122
24	14x18	69	39,8	97,50	1	006530124
*27	14x18	76	44,8	97,50	1	006530127
*30	14x18	77	44,8	97,50	1	006530130
*32	14x18	79	44,8	97,50	1	006530132
*34	14x18	80	44,8	140,00	1	006530134
*36	14x18	80	44,8	140,00	1	006530136
*41	14x18	90	49,8	140,00	1	006530141

\*Atenção! Recalcular o valor do binário conforme indicado na tabela que se encontra no fim do catálogo

## 666N

chaves dinamométricas com roquetes reversíveis, para aperto à direita, precisão de torque:  $\pm 3\%$



UNI EN ISO 6789

Nm	Kgfm	lbf.ft	mm	D mm	A mm	L mm	g
5÷25	0,5÷2,5	4÷18	1/4	25	29	220	300
<b>666N/2</b> 286,00 1 006660002							
5÷25	0,5÷2,5	4÷18	3/8	25	29	220	300
<b>666N/2X</b> 293,00 1 006660003							
10÷50	1÷5	7÷37	3/8	30	33	325	660
<b>666N/5</b> 211,00 1 006660005							
20÷100	2÷10	15÷75	3/8	30	33	367	730
<b>666N/10</b> 213,00 1 006660010							
20÷100	2÷10	15÷75	1/2	30	37	367	800
<b>666N/10X</b> 217,00 1 006660011							
40÷200	4÷20	30÷150	1/2	40	43	465	1010
<b>666N/20</b> 232,00 1 006660020							
60÷300	6÷30	50÷220	1/2	40	43	581	1380
<b>666N/30</b> 264,00 1 006660030							

## 666N LBF.IN

chaves dinamométricas com roquetes reversíveis, para aperto à direita, precisão de torque:  $\pm 3\%$

• Escala em libras, força por polegada



UNI EN ISO 6789

lbf.in	mm	D mm	A mm	L mm	g
90÷440	3/8	30	33	325	660
<b>666N-LBF.IN/5</b> 211,00 1 006660055					
200÷800	3/8	30	33	367	730
<b>666N-LBF.IN/10</b> 213,00 1 006660070					
200÷800	1/2	30	37	367	800
<b>666N-LBF.IN/10X</b> 217,00 1 006660071					
400÷1800	1/2	40	43	465	1010
<b>666N-LBF.IN/20</b> 232,00 1 006660072					
500÷3000	1/2	40	43	581	1380
<b>666N-LBF.IN/30</b> 264,00 1 006660073					



## 667N

chaves dinamométricas para operações à esquerda e à direita, precisão de torque:  $\pm 3\%$



UNI EN ISO 6789

Nm	Kgfm	lbf.ft	mm	D mm	A mm	L mm	g
40÷200	4÷20	30÷150	1/2	40	43	465	1010
<b>667N/20</b> 224,00 1 006670020							
60÷300	6÷30	50÷220	1/2	40	43	581	1380
<b>667N/30</b> 249,00 1 006670030							
80÷400	8÷40	60÷295	3/4	50	50	687	2090
<b>667N/40</b> 605,00 1 006670040							

Ver quadro depois do artigo 929/C8 para acessórios compatíveis usados

## 668N

barras de aperto, para operações à esquerda e à direita, precisão de torque:  $\pm 3\%$



UNI EN ISO 6789

Nm	Kgfm	lbf.ft	mm	Ø mm	L mm	LB mm	LS mm	g
5÷25	0,5÷2,5	4÷18	16	220	148	32	300	
<b>668N/2</b> 213,00 1 006680002								
10÷50	1÷5	7÷37	16	307	229	32	590	
<b>668N/5</b> 208,00 1 006680005								
20÷100	2÷10	15÷75	16	376	269	32	670	
<b>668N/10</b> 212,00 1 006680010								

Nm	Kgfm	lbf.ft	∅	L	LB	LS	g
40÷200	4÷20	30÷150	16	450	352,6	32	795
			€				
<b>668N/20</b>			<b>229,00</b>	1	006680020		

Nm	Kgfm	lbf.ft	∅	L	LB	LS	g
60÷300	6÷30	50÷220	16	588	475,9	32	1230
			€				
<b>668N/30</b>			<b>262,00</b>	1	006680030		

## 668RG

barra dinamométrica não graduada para apertos à direita e à esquerda  
precisão: ±4%  
(para utilização com artigos 680 - 682)



UNI EN ISO 6789

Nm	Kgfm	lbf.ft	∅	L	g		
8÷60	0,8÷6	6÷44	16	288	550		
			€				
<b>668RG/6</b>			<b>169,00</b>	1	006680206		

Nm	Kgfm	lbf.ft	∅	L	g		
20÷100	2÷10	15÷80	16	315	600		
			€				
<b>668RG/10</b>			<b>174,00</b>	1	006680210		

Nm	Kgfm	lbf.ft	∅	L	g		
40÷200	4÷20	30÷150	16	405	780		
			€				
<b>668RG/20</b>			<b>186,00</b>	1	006680220		

Nm	Kgfm	lbf.ft	∅	L	g		
60÷300	6÷30	50÷220	16	645	1130		
			€				
<b>668RG/30</b>			<b>209,00</b>	1	006680230		

## 669N

barras dinamométricas, encabadouro rectangular, para operações à esquerda e à direita, precisão de torque: ±3%

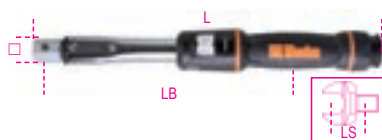

UNI EN ISO 6789

Nm	Kgfm	lbf.ft	□	L	LB	LS	g
5÷25	0,5÷2,5	4÷18	9x12	215	140	28,8	300
			€				
<b>669N/2</b>			<b>301,00</b>	1	006690202		

Nm	Kgfm	lbf.ft	□	L	LB	LS	g
10÷50	1÷5	7÷37	9x12	307	226,8	28,8	590
			€				
<b>669N/5</b>			<b>233,00</b>	1	006690205		

Nm	Kgfm	lbf.ft	□	L	LB	LS	g
20÷100	2÷10	15÷75	9x12	376	266,8	28,8	670
			€				
<b>669N/10</b>			<b>249,00</b>	1	006690210		

Nm	Kgfm	lbf.ft	□	L	LB	LS	g
40÷200	4÷20	30÷150	9x12	450	345,6	28,8	795
			€				
<b>669N/20</b>			<b>299,00</b>	1	006690220		

Nm	Kgfm	lbf.ft	□	L	LB	LS	g
40÷200	4÷20	30÷150	14x18	450	351	39,8	795
			€				
<b>669N/20X</b>			<b>317,00</b>	1	006690221		

Nm	Kgfm	lbf.ft	□	L	LB	LS	g
60÷300	6÷30	50÷220	14x18	588	468,5	39,8	1230
			€				
<b>669N/30</b>			<b>333,00</b>	1	006690230		

Nm	Kgfm	lbf.ft	□	L	LB	LS	g
80÷400	8÷40	60÷295	14x18	588	563	39,8	2100
			€				
<b>669N/40</b>			<b>385,00</b>	1	006690240		

## 671B/C5

Jogo com 1 barra dinamométrica ref. 604B/5, 1 roquete reversível, 8 chaves de caixa sextavadas e 4 ponteiros boca



		€				
<b>671B/C5</b>		<b>842,00</b>	1	006710001		
	<b>604B/5</b>	1÷5 Nm				
	<b>611</b>	1/4				
	<b>641</b>	5-6-7-8 mm				
	<b>900</b>	4-5-5,5-6-7-8-9-10 mm				
		€				
		<b>270x120x45 mm</b>			<b>1,3 kg</b>	

## 671B/C10

Jogo com 1 barra dinamométrica ref. 604B/10, 1 roquete reversível, 8 chaves de caixa sextavadas e 4 ponteiros boca



		€				
<b>671B/C10</b>		<b>842,00</b>	1	006710002		
	<b>604B/10</b>	2÷10 Nm				
	<b>611</b>	1/4				
	<b>641</b>	6-7-8-10 mm				
	<b>900</b>	4-5-5,5-6-7-8-9-10 mm				
		€				
		<b>270x120x45 mm</b>			<b>1,4 kg</b>	

## 671N/C10

barra dinamométrica 668N/10 e acessórios



		€				
<b>671N/C10</b>		<b>950,00</b>	1	006710110		
	<b>668N/10</b>	100 Nm				
	<b>612</b>	3/8				
	<b>617</b>	3/8				
	<b>642</b>	10-13-14-17-19 mm				
	<b>652</b>	10-13-14-17-19 mm				
	<b>910A</b>	3/8 8-10-11-13-14-17-19 mm				
	<b>910/21</b>	125 mm				
	<b>910/22</b>	250 mm				
		€				
		<b>400x180x45 mm</b>			<b>4,3 kg</b>	

## 671N/C20

barra dinamométrica 668N/20 e acessórios



		€				
<b>671N/C20</b>		<b>1.007,00</b>	1	006710120		
	<b>668N/20</b>	200 Nm				
	<b>614</b>	1/2				
	<b>619</b>	1/2				
	<b>642</b>	10-13-14-17-19 mm				
	<b>652</b>	10-13-14-17-19 mm				
	<b>920A</b>	1/2 10-11-13-14-17-19-22 mm				
	<b>920/20</b>	75 mm				
	<b>920/21</b>	125 mm				
	<b>920/22</b>	255 mm				
		€				
		<b>510x180x45 mm</b>			<b>5,5 kg</b>	

## 671N/C30

barra dinamométrica 668N/30 e acessórios



		€				
<b>671N/C30</b>		<b>956,00</b>	1	006710130		
	<b>668N/30</b>	300 Nm				
	<b>614</b>	1/2				
	<b>619</b>	1/2				
	<b>642</b>	13-14-17-19 mm				
	<b>652</b>	13-14-17-19 mm				
	<b>920A</b>	1/2 13-14-17-19-22-24-27 mm				
	<b>920/20</b>	75 mm				
	<b>920/21</b>	125 mm				
	<b>920/22</b>	255 mm				
		€				
		<b>620x180x45 mm</b>			<b>5,8 kg</b>	

## 677

chaves dinamométricas com embraiagem e roquete simples para aperto direito e esquerdo precisão:  $\pm 4\%$



UNI EN ISO 6789

Nm	Kgfm	lbf.ft	D mm	A mm	L mm	kg
100÷500	10÷50	70÷350	70	55	915	5,2

677/50 € 714,00 1 006770050

Nm	Kgfm	lbf.ft	D mm	A mm	L mm	kg
150÷700	15÷70	100÷500	70	55	1140	6,2

677/70 € 747,00 1 006770070

Nm	Kgfm	lbf.ft	D mm	A mm	L mm	kg
300÷1000	30÷100	200÷750	70	55	1470	7,5

677/100 € 774,00 1 006770100

## 677/C

chaves dinamométricas com roquetes móveis para aperto à esquerda e à direita, precisão de torque:  $\pm 4\%$  fornecidas em estojo

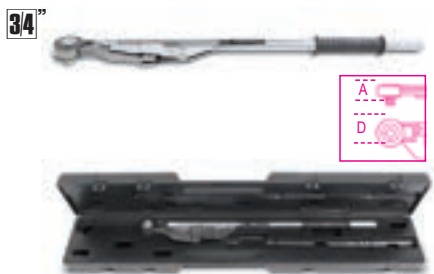

UNI EN 26789  
ISO 6789

Nm	Kgfm	lbf.ft	D mm	A mm	L mm	kg
100÷500	10÷50	70÷350	70	55	915	5,2

677/C50 € 830,00 1 006770606

Nm	Kgfm	lbf.ft	D mm	A mm	L mm	kg
150÷700	15÷70	100÷500	70	55	1140	6,2

677/C70 € 863,00 1 006770611

Nm	Kgfm	lbf.ft	D mm	A mm	L mm	kg
300÷1000	30÷100	200÷750	70	55	1470	7,5

677/C100 € 992,00 1 006770615

Nm	Kgfm	lbf.ft	D mm	A mm	L mm	kg
700÷1500	70÷150	500÷1000	70	70	1475	10,4

677/C150 € 1.275,00 1 006770620

## 677/CP200

chave dinamométrica com embraiagem e roquete simples para aperto à direita e esquerda precisão:  $\pm 4\%$  em estojo



UNI EN ISO 6789

Nm	Kgfm	lbf.in	D mm	A mm	L mm	kg
900÷2000	90÷200	600÷1500	70	63	1920	13

677/CP200 € 2.400,00 1 006770720

## 678/C

chaves dinamométricas com roquetes móveis para aperto à esquerda e à direita precisão  $\pm 4\%$  fornecidas em estojo

• Modelos 678/C100 e 678/C150 fornecidos com extensões.

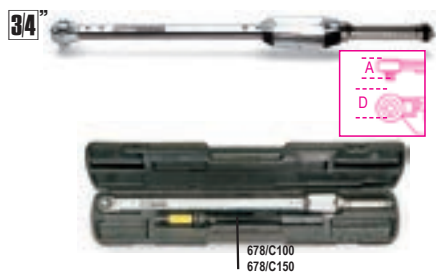

Nm	Kgfm	lbf.ft	D mm	A mm	L mm	kg
130÷650	13÷65	100÷480	63	55	885	3,9

678/C65 € 1.400,00 1 006780607

Nm	Kgfm	lbf.ft	D mm	A mm	L mm	kg
300÷1000	30÷100	220÷750	75	60	1250	6,0

678/C100 € 1.875,00 1 006780611

Nm	Kgfm	lbf.ft	D mm	A mm	L mm	kg
500÷1500	50÷150	370÷1100	75	60	1570	8,5

678/C150 € 2.065,00 1 006780615

## 677/CV - 678/CV

caixas metálicas para chaves dinamométricas modelos 677 e 678



677/CV1 € 116,00 1 006770450

677/C50-677/C70 € 109,00 1 006780500

678/CV2 € 218,00 1 006780415

677/C100-677/C150-678/C150 € 109,00 1 006780415

## 680

controlador eletrônico de binário Dynatester 680 para verificação da calibragem, possibilidade de utilização em sentido horário ou anti-horário

• Precisão:  $\pm 1\%$   
• 3 unidades de medida: Nm - lbf.ft. - lbf.in



	Nm	kg	€		
680/2,5	1÷25	2,6	1.885,00	1	006800002
680/40	15÷400	4,0	1.895,00	1	006800040
680/100	100÷1000	4,8	2.710,00	1	006800100

## 682

controlador de binário electrónico digital com transdutor Dynatester 682, para uso à direita e à esquerda

Alta precisão de leitura  
Fornecido com porta série RS-232 para impressoras



### CARACTERÍSTICAS TÉCNICAS

Precisão de leitura:  $\pm 1\%$  do valor lido

Unidades de medida seleccionáveis

Nm-dNm-cNm-Lbf.ft-Lbf.in-Ozf.in-Kgf.m-Kgf.cm-gf.cm

Alimentação: 90 a 264 V AC a 50/60 Hz

Dimensões: 235x185x185 mm

Tolerância de teste de acordo com a norma ISO 6789

Escala aceite para cada chave dinamométrica testada

Visor: Menu disponível em 11 línguas

Fornecido com todos os certificados necessários

Certificado de calibração com rastreabilidade UKAS

	Nm	kg	€		
682/60	1,2÷60	5,9	5.040,00	1	006820006
682/400	8÷400	6,1	5.120,00	1	006820040
682/1500	30÷1500	6,4	5.280,00	1	006820150

## 710

chaves de impacto série normal



UNI/ISO 2725 DIN 3129

Ø	Ø	L	Ø1	€	Unid.	Art.
mm	mm	mm	mm			
7	12,5	28	19	7,75	3	007100007
8	13,8	28	19	7,75	3	007100008
9	15,0	28	19	7,75	3	007100009
10	16,3	28	19	7,75	3	007100010
11	17,5	30	19	7,75	3	007100011
12	19,0	30	19	7,75	3	007100012
13	20,0	30	22	8,20	3	007100013
14	21,3	30	22	8,20	3	007100014
16	23,8	30	22	8,20	3	007100016
17	25,0	30	22	8,20	3	007100017
18	26,3	30	22	8,55	3	007100018
19	27,5	30	22	8,55	3	007100019
21	30,0	32	22	9,30	3	007100021
22	32,0	32	22	10,20	3	007100022

## 710/16

adaptador quadra fêmea de 3/8" para quadra macho de 1/2"

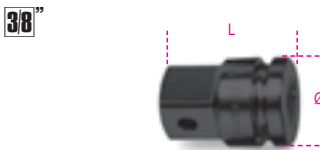

L	Ø	€	Unid.	Art.
mm	mm			
32	22	21,00	3	007100810

## 710/20

extensões com quadras macho e fêmea de 3/8"



L	Ø	€	Unid.	Art.
mm	mm			
75	22	21,00	2	007100821

## 710/21

extensões com quadras macho e fêmea de 3/8"



L	Ø	€	Unid.	Art.
mm	mm			
125	22	23,20	2	007100823

## 710/25

cardan com quadras macho e fêmea de 3/8"

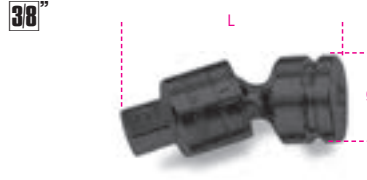

L	Ø	€	Unid.	Art.
mm	mm			
58	24	44,50	2	007100830

## 710/C10

jogo com 10 chaves de impacto



710/C10	€	Unid.	Art.
7-8-10-11-12-13 14-17-19-22 mm	94,50	1	007100910

130x55x40 mm - 800 g

## 710/OR... - 710/SP...

anéis em borracha e cavilhas de fixação para chaves de impacto e acessórios



710/OR1	710	710/16	€	Unid.	Art.
	mm	L mm			
710/OR2	7+12	32	0,65	10	007100922
710/SP1	13+22		0,65	10	007100922
710/SP2	7+12		1,15	10	007100911
	13+22	32	1,15	10	007100912

## 720

chaves de impacto série normal



UNI/ISO 2725 DIN 3129

Ø	Ø	L	Ø1	€	Unid.	Art.
mm	mm	mm	mm			
10	17,0	38	25	9,60	5	007200010
11	18,5	38	25	9,60	5	007200011
12	20,0	38	25	9,60	5	007200012
13	21,0	38	25	9,60	5	007200013
14	22,5	38	25	9,60	5	007200014
15	23,0	38	30	10,70	5	007200015
16	25,0	38	30	10,70	5	007200016
17	26,0	38	30	10,70	5	007200017
18	27,5	38	30	10,70	5	007200018
19	28,5	38	30	10,70	5	007200019
21	31,0	38	30	11,90	5	007200021
22	32,5	38	30	11,90	5	007200022
23	34,0	38	30	13,00	5	007200023

Ø	Ø	L	Ø1	€	Unid.	Art.
mm	mm	mm	mm			
24	35,0	38	30	13,00	5	007200024
27	38,5	45	30	15,30	3	007200027
30	42,0	50	30	16,40	3	007200030
32	44,0	50	30	18,60	3	007200032
36	50,0	50	30	27,50	3	007200036

## 720AS

chaves de impacto, série normal



Ø	Ø	L	Ø1	€	Unid.	Art.
mm	mm	mm	mm			
3/8	17,0	38	25	15,60	2	007200210
7/16	18,2	38	25	15,60	2	007200211
1/2	20,7	38	25	15,60	2	007200213
9/16	22,0	38	25	15,60	2	007200214
5/8	24,5	38	30	16,70	2	007200216
11/16	25,7	38	30	16,70	2	007200217
3/4	28,2	38	30	16,70	2	007200219
13/16	30,7	38	30	17,90	2	007200221
7/8	32,0	38	30	17,90	2	007200222
15/16	34,5	38	30	19,00	2	007200224
1	35,7	38	30	20,20	2	007200225
1.1/16	38,2	40	30	22,10	1	007200227
1.1/8	40,7	42	30	24,90	1	007200229
1.1/4	44,5	42	30	27,00	1	007200232

## 720L

chaves de impacto série longa



UNI/ISO 2725

Ø	Ø	L	Ø1	€	Unid.	Art.
mm	mm	mm	mm			
10	17,0	80	25	16,50	2	007200310
11	18,5	80	25	16,50	2	007200311
12	20,0	80	25	16,50	2	007200312
13	21,0	80	25	16,50	2	007200313
14	22,5	80	25	16,50	2	007200314
15	23,0	80	30	18,70	2	007200315
16	25,0	80	30	18,70	2	007200316
17	26,0	80	30	18,70	2	007200317
18	27,5	80	30	19,80	2	007200318
19	28,5	80	30	19,80	2	007200319
21	31,0	80	30	21,00	2	007200321
22	32,5	80	30	21,00	2	007200322
24	35,0	80	30	21,50	2	007200324
27	38,5	80	30	26,50	2	007200327
30	42,0	80	30	34,00	2	007200330
32	44,0	80	30	34,00	2	007200332
36	50,0	80	30	51,50	2	007200336

## 720L/S3

jogo de 3 chaves de impacto 720L



Ø	€	Unid.	Art.
mm			
17-19-21	59,50	1	007200355

## 720LS

chaves de impacto, série longa



UNI/ISO 2725

Ø mm	Ø mm	L mm	Ø1 mm	€	🔧	📦
10	15,5	78	24	17,80	2	007200360
11	16,7	78	24	17,80	2	007200361
12	18,0	78	24	17,80	2	007200362
13	19,2	78	24	17,80	2	007200363
14	20,5	78	24	17,80	2	007200364
15	21,7	78	24	20,40	2	007200365
16	23,0	78	24	20,40	2	007200366
17	24,2	78	29	20,40	2	007200367
18	25,5	78	29	22,10	2	007200368
19	26,7	78	29	22,10	2	007200369
21	29,2	78	29	23,20	2	007200371
22	30,5	78	29	23,20	2	007200372
24	33,0	78	29	23,70	2	007200374
27	36,7	78	29	29,00	2	007200377
30	40,5	78	29	37,00	2	007200380
32	43,0	78	29	37,00	2	007200382
36	48,0	78	29	57,00	2	007200386

## 720LC

chaves de impacto para porcas de roda, com inserts coloridos em polímero



Ø mm	Ø mm	€	🔧	📦
17	26,5	11,50	2	007200637
19	28,5	11,50	2	007200639
21	30,3	12,00	2	007200641
22	32,4	12,60	2	007200642
24	34,6	13,70	2	007200644



720LC/C3	€	🔧	📦
17-19-21 mm	35,00	1	007200653

148x132x44 mm - 860 g



720LC/S5	€	🔧	📦
17-19-21-22-24 mm	61,50	1	007200645

## 720IC

inserts sobresselentes coloridos em polímero para chaves de impacto 720LC-720LCL



	Ø mm	€	🔧	📦
720IC 17	17	4,40	1	007200687
720IC 19	19	4,40	1	007200689
720IC 21	21	4,40	1	007200691
720IC 22	22	4,40	1	007200692
720IC 24	24	4,40	1	007200694

## 720LCL

chaves de impacto para porcas de roda, com inserts coloridos em polímero, série longa



Ø mm	Ø mm	€	🔧	📦
17	26,5	19,10	1	007200737
19	28,5	19,10	1	007200739
21	30,3	19,10	1	007200741



720LCL/C3	€	🔧	📦
17-19-21 mm	73,50	1	007200753

210x50x150 mm - 1,65 kg

## 720MRC

chave de impacto com insert polimérico parafusos de rodas Mercedes



Ø mm	Ø mm	L mm	€	🔧	📦
17	27	85	17,50	1	007200631



## 720TC

barras de torção de impacto, coloridas, para porcas de rodas de automóveis, com quadras macho e fêmea 1/2



Nm	L mm	€	🔧	📦
90	200	19,10	1	007200769
100	200	19,10	1	007200770
110	200	19,10	1	007200771
120	200	19,10	1	007200772
135	200	19,10	1	007200773



720TC/S5	€	🔧	📦
90-100-110-120-135 Nm	95,50	1	007200779

260x50x175 mm - 1,35 kg

## 720FTX

chaves de caixa para parafusos com perfil Torx®



Ø mm	L mm	Ø1 mm	€	🔧	📦	
E10	14,0	38	25	15,30	2	007200410
E12	15,9	38	25	15,30	2	007200412
E14	17,7	38	25	15,30	2	007200414
E16	20,0	38	25	15,30	2	007200416
E18	22,0	38	25	15,30	2	007200418
E20	25,0	40	25	16,40	2	007200420



720FTX/SB6	€	🔧	📦
E10-E12-E14-E16-E18-E20	101,00	1	007200450

## 720TX

chaves de impacto para parafusos Torx®



Ø mm	L mm	L1 mm	€	🔧	📦	
T30	25	78	54	13,20	3	007200460
T40	25	78	54	13,20	3	007200470
T45	25	78	54	13,70	3	007200472
T50	25	78	54	13,70	3	007200474
T55	25	78	54	15,30	3	007200476
T60	25	78	54	16,40	3	007200478

## 720TX/C6

jogo de 6 chaves de impacto para parafusos Torx® em caixa metálica



720TX/C6 111,00 € 1 007200483  
T30-T40-T45  
T50-T55-T60

275x120x65 mm - 5700 g

## 720ME

chaves de impacto sextavadas



mm	Ø mm	L mm	L1 mm	€		
5	25	78	54	12,70	3	007200505
6	25	78	54	12,70	3	007200506
8	25	78	54	12,70	3	007200508
10	25	78	54	12,70	3	007200510
12	25	78	54	12,70	3	007200512
14	25	78	54	14,50	3	007200514
17	25	78	54	14,50	3	007200517
19	25	78	54	14,50	3	007200519

## 720ME/C8

jogo de 8 chaves de impacto sextavadas



720ME/C8 133,00 € 1 007200525  
5-6-8-10-12  
14-17-19 mm

270x120x45 mm - 1710 g

## 720/15

adaptador quadra fêmea de 1/2" para quadra macho de 3/8"



L mm	Ø mm	□	■	€		
37,5	25	1/2	3/8	13,70	3	007200810



Aplique sempre uma força de aperto regular e progressiva, a fim de evitar a ruptura do material e de se proteger de um possível acidente

## 720/16

adaptador quadra fêmea de 1/2" para quadra macho de 3/4"



L mm	Ø mm	□	■	€		
44	30	1/2	3/4	18,60	3	007200814

## 720/20

extensões com quadras macho e fêmea de 1/2"



L mm	Ø mm	€		
75	25	18,90	3	007200818

## 720/21

extensões com quadras macho e fêmea de 1/2"



L mm	Ø mm	€		
125	25	20,50	3	007200822

## 720/25

cardan com quadras macho e fêmea de 1/2"



L mm	Ø mm	€		
64	28	40,00	2	007200831

## 720/C6

jogo com 6 chaves de impacto



720/C6 83,00 € 1 007200910  
13-14-17-19-22-24 mm

195x80x55 mm - 1100 g

## 720/C12

jogo com 12 chaves de impacto



720/C12 162,00 € 1 007200912  
10-11-12-13-14-17  
19-22-24-27-30-32 mm

195x80x55 mm - 2000 g

## 720/OR... - 720/SP...

anéis em borracha e cavilhas de fixação para chaves de impacto e acessórios

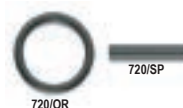

	720 mm	720TX	€		
720/OR1	10+14	T30+T60	1,15	10	007200923
720/OR2	15+32		1,15	10	007200924
720/SP1	10+14	T30+T60	1,75	10	007200913
720/SP2	15+32		1,75	10	007200914

## 727PI/16

chave porta-pontas de impacto 16 mm para os artigos 727/ES16 e 727/ES16TX



Ø mm	L mm	□	■	€		
44	52	16	3/4	41,50	2	007270016

## 727/ES16

pontas de impacto sextavados 16 mm



mm	Ø mm	L mm	€	🔧	📦
10	16	40	14,00	2	007270110
12	16	40	14,00	2	007270112
13	16	40	14,00	2	007270113
14	16	40	14,00	2	007270114
16	16	40	15,10	2	007270116
17	16	40	15,10	2	007270117
18	16	40	15,60	2	007270118
19	16	40	15,60	2	007270119
22	16	40	18,00	2	007270122

## 727/ES16TX

pontas de impacto 16 mm para parafusos Torx®



mm	Ø mm	L mm	€	🔧	📦
T55	16	50	21,00	2	007270355
T60	16	50	21,00	2	007270360
T70	16	50	21,00	2	007270370

## 727PI/22

chave porta-pontas de impacto 22 mm para os artigos 727/ES22 e 727/ES22TX



Ø mm	L mm	Ø1 mm	€	🔧	📦
54	70	22	65,00	2	007270022

## 727/ES22

pontas de impacto sextavados 22 mm



mm	Ø mm	L mm	€	🔧	📦
19	22	50	18,00	2	007270219
22	22	50	18,00	2	007270222
24	22	50	19,90	2	007270224
27	22	50	22,10	2	007270227
30	22	50	26,50	2	007270230
32	22	50	29,00	2	007270232

## 727/ES22TX

pontas de impacto 22 mm para parafusos Torx®



mm	Ø mm	L mm	€	🔧	📦
T80	22	60	29,50	2	007270480
T90	22	60	29,50	2	007270490
T100	22	60	29,50	2	007270500

## 727/C16

jogo com 12 pontas de impacto e 4 acessórios



Artigo	Quantidade	Preço Unitário (€)	Preço Total (€)	🔧	📦
727/C16	1	398,00	398,00	1	007270900

727PI/16

727/ES16 14-17-19 mm

727/ES16TX T55-T60-T70

727PI/22

727/ES22 22-24-27 mm

727/ES22TX T80-T90-T100

96BPC 3-4 mm

335x145x60 mm - 3,6 kg

## 727PI/32

chave porta-pontas de impacto 32 mm para os artigos 727/ES22 e 727/ES22TX



Ø mm	L mm	Ø1 mm	€	🔧	📦
86	66	32	159,00	1	007270032

## 727/ES32

pontas de impacto sextavados 32 mm



mm	Ø mm	L mm	€	🔧	📦
19	32	44	41,00	2	007270519
22	32	44	41,00	2	007270522
24	32	44	41,00	2	007270524
27	32	44	41,00	2	007270527
30	32	44	41,00	2	007270530
32	32	44	41,00	2	007270532
36	32	44	46,00	2	007270536

## 728

chaves de impacto série normal



UNI/ISO 2725 DIN 3129

mm	Ø mm	L mm	Ø1 mm	€	🔧	📦
17	30,0	51	44	23,50	2	007280017
18	31,0	51	44	23,50	2	007280018
19	32,5	51	44	23,50	2	007280019
21	35,0	51	44	23,50	2	007280021
22	36,0	51	44	23,50	2	007280022
23	37,5	51	44	24,00	2	007280023
24	38,5	51	44	24,00	2	007280024
27	42,5	53	44	24,00	2	007280027
28	44,0	53	44	24,90	2	007280028
30	46,0	53	44	24,90	2	007280030
32	48,5	57	44	26,00	2	007280032
33	50,0	57	44	28,50	2	007280033
34	51,0	57	44	28,50	2	007280034
35	52,5	57	44	29,00	2	007280035
36	53,5	57	44	30,00	2	007280036
38	56,0	57	44	33,50	1	007280038
40	58,5	58	44	36,00	1	007280040
41	60,0	58	44	36,00	1	007280041
44	64,0	62	44	40,00	1	007280044
45	65,0	62	44	43,00	1	007280045
46	66,0	62	44	43,00	1	007280046
50	71,0	68	54	51,50	1	007280050
55	77,5	71	54	56,50	1	007280055
60	83,0	73	54	64,00	1	007280060
65	88,0	78	54	71,50	1	007280065

## 728FTX

chave de impacto para parafusos de perfil Torx®

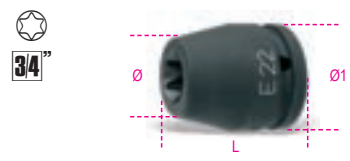

mm	Ø mm	L mm	Ø1 mm	€	🔧	📦
E20	28,5	50	44	31,00	2	007280420
E22	30,0	50	44	31,00	2	007280422
E24	32,5	50	44	31,00	2	007280424

## 728L

chaves de impacto série longa



mm	Ø mm	L mm	Ø1 mm	€	🔧	📦
19	32,5	90	44	37,50	2	007280319
21	35,0	90	44	37,50	2	007280321
22	36,0	90	44	37,50	2	007280322
24	38,5	90	44	37,50	2	007280324
26	41,0	90	44	37,50	2	007280326
27	42,5	90	44	37,50	2	007280327
30	46,0	90	44	39,00	2	007280330
32	48,5	90	44	41,00	2	007280332
33	50,0	90	44	44,00	1	007280333
34	51,0	90	44	46,00	1	007280334
36	53,5	90	44	49,00	1	007280336
38	56,0	90	44	54,00	1	007280338
41	60,0	90	44	57,00	1	007280341
46	66,0	90	44	65,50	1	007280346
50	71,0	90	44	78,00	1	007280350
55	77,5	100	54	101,50	1	007280355



## 728LS

chaves de impacto série longa com paredes finas



mm	Ø	L	Ø1	€		
17	28,0	100	43	42,00	2	007280517
19	30,5	100	43	42,00	2	007280519
22	34,3	100	43	42,00	2	007280522
24	36,8	100	43	42,00	2	007280524
27	40,5	100	43	42,00	2	007280527
30	44,3	100	43	42,00	2	007280530
32	46,8	100	43	46,50	2	007280532
33	48,0	100	43	46,50	2	007280533
36	51,8	100	43	54,00	1	007280536

## 728LQ

chaves de impacto, série longa

(para porcas de rodas ISUZU)



mm	L	Ø	Ø1	€		
19	90	35	43,5	36,00	1	007280619
21	90	42	43,5	36,00	1	007280621

## 728/15

redução quadra fêmea de 3/4" para quadra macho de 1/2"



L	Ø	□	■	€		
58	38	3/4	1/2	29,00	2	007280810



Aplique sempre uma força de aperto regular e progressiva, a fim de evitar a ruptura do material e de se proteger de um possível acidente

## 728/16

adaptador quadra fêmea de 3/4" para quadra macho de 1"



L	Ø	□	■	€		
62	44	3/4	1	35,50	2	007280813

## 728/21

extensões com quadras macho e fêmea de 3/4"



L	Ø	€		
175	44	43,50	2	007280815

## 728/22

extensões com quadras macho e fêmea de 3/4"



L	Ø	€		
250	44	50,00	2	007280825

## 728/22L

extensões com quadras macho e fêmea de 3/4"



L	Ø	€		
330	44	63,50	1	007280826

## 728/25

cardan com quadras macho e fêmea de 3/4"

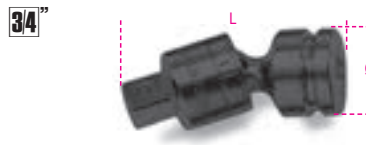

L	Ø	€		
107,5	44	84,00	1	007280830

## 728/C10

jogo com 10 chaves de impacto



728/C10	€		
17-19-22-24-27-30 32-36-41-46 mm	305,00	1	007280910

275x120x65 mm - 5,7 kg

## 728/OR - 728/SP

anéis em borracha e cavilhas de fixação para chaves de impacto e acessórios



728/OR	728/SP	728	728FTX	€		
728/15		mm		1,70	5	007280925
17+46	E20+E24			1,80	10	007280926
17+46	E20+E24			2,40	10	007280916

## 729

chaves de impacto série normal



UNI/ISO 2725 DIN 3129

mm	Ø	L	Ø1	€		
24	41,5	58	54	37,50	1	007290024
27	45,0	60	54	37,50	1	007290027
30	49,0	62	54	37,50	1	007290030
32	51,5	63	54	38,50	1	007290032
33	52,5	63	54	38,50	1	007290033
34	54,0	63	54	38,50	1	007290034
36	56,5	66	54	38,50	1	007290036
38	59,0	66	54	46,50	1	007290038
41	62,5	68	54	47,50	1	007290041
46	69,0	72	54	53,00	1	007290046
50	74,0	76	54	65,50	1	007290050
55	80,0	84	54	70,50	1	007290055
60	86,5	88	54	86,00	1	007290060
65	92,5	92	54	98,00	1	007290065
70	99,0	96	54	117,00	1	007290070
75	105,0	102	63	145,00	1	007290075
80	111,5	102	63	156,00	1	007290080

## 729L

chaves de impacto série longa



mm	Ø	L	Ø1	€		
24	41,5	108	54	66,50	1	007290324
27	45,0	108	54	66,50	1	007290327
30	49,0	108	54	66,50	1	007290330
32	51,5	108	54	66,50	1	007290332
33	52,2	108	54	66,50	1	007290333
34	54,0	108	54	66,50	1	007290334
36	56,5	108	54	66,50	1	007290336
41	62,5	108	54	80,50	1	007290341
46	69,0	108	54	93,00	1	007290346
50	74,0	108	54	104,00	1	007290350
55	80,0	108	54	125,00	1	007290355
60	86,5	108	54	136,00	1	007290360
65	92,5	108	54	164,00	1	007290365
70	99,0	108	54	187,00	1	007290370
75	105,0	108	63	210,00	1	007290375
80	111,5	108	63	221,00	1	007290380

Beta

Beta

## 729LS

chaves de impacto série longa com paredes finas



mm	Ø mm	L mm	Ø1 mm	€	1	007290522
22	36,0	108	53	66,50	1	007290522
24	38,5	108	53	66,50	1	007290524
27	42,3	108	53	66,50	1	007290527
30	46,0	108	53	70,50	1	007290530
32	48,5	108	53	70,50	1	007290532
33	49,8	108	53	70,50	1	007290533
36	53,5	108	53	70,50	1	007290536

## 729T

barra de torção de impacto para cubos de roda



mm	Nm	L mm	€	1	007290724
24	350	300	121,00	1	007290724
27	450	300	121,00	1	007290757
30	500	300	123,00	1	007290730
32	450	300	125,00	1	007290732
32	600	300	125,00	1	007290762
33	600	300	131,00	1	007290763
36	600	300	138,00	1	007290736

## 729/15

redução quadra fêmea de 1" para quadra macho de 3/4"



L mm	Ø mm	1	3/4	€	1	007290810
66,5	54	1	3/4	45,00	1	007290810



Aplique sempre uma força de aperto regular e progressiva, a fim de evitar a ruptura do material e de se proteger de um possível acidente

## 729/16

redução quadra fêmea de 1" para quadra macho de 1.1/2"



L mm	Ø mm	1	1.1/2	€	1	007290813
88	54,0	1	1.1/2	75,00	1	007290813

## 729/21

extensões com quadras macho e fêmea de 1"



L mm	Ø mm	€	1	007290815
175	54	70,00	1	007290815

## 729/22

extensões com quadras macho e fêmea de 1"



L mm	Ø mm	€	1	007290825
330	54	100,50	1	007290825

## 729/25

cardan com quadras macho e fêmea de 1"

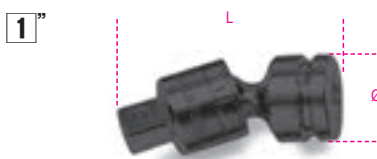

L mm	Ø mm	€	1	007290830
130	54	147,00	1	007290830

## 729/OR... - 729/SP...

anéis em borracha e cavilhas de fixação para chaves de impacto e acessórios



	728 mm	729-730 mm	€	5	007290927
729/OR1	50+60	24+70	1,80	5	007290927
729/OR2	75+125		2,85	5	007290928
729/SP1	50+60	24+70	1,70	5	007290917
729/SP2	75+125		2,95	5	007290918

## 730

chaves de impacto série normal



UNI/ISO 2725 DIN 3129

mm	Ø mm	L mm	Ø1 mm	€	1	007300050
50	81	87	84	190,00	1	007300050
55	88	90	86	202,00	1	007300055
60	94	95	86	218,00	1	007300060
65	100	100	86	247,00	1	007300065
70	106	105	86	292,00	1	007300070
75	113	110	86	336,00	1	007300075
80	119	115	86	386,00	1	007300080
85	125	120	86	431,00	1	007300085
90	132	125	86	487,00	1	007300090
95	138	125	96	571,00	1	007300095
100	144	130	96	660,00	1	007300100
105	150	135	96	738,00	1	007300105
110	157	140	96	799,00	1	007300110
115	163	140	96	861,00	1	007300115
120	169	145	96	962,00	1	007300120
125	175	145	96	1.007,00	1	007300125

## 730/15

adaptadores



L mm	Ø mm	1.1/2	1	€	1	007300810
105	84,0	1.1/2	1	151,00	1	007300810



Aplique sempre uma força de aperto regular e progressiva, a fim de evitar a ruptura do material e de se proteger de um possível acidente

## 733/15

adaptadores

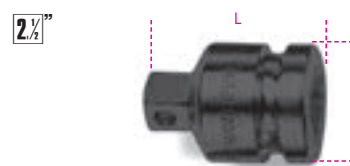

L mm	Ø mm	2.1/2	1.1/2	€	1	007330810
156	127	2.1/2	1.1/2	548,00	1	007330810

## 851

porta pontas magnético com punho

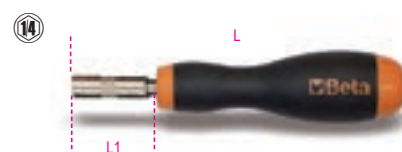

L1 mm	L mm	€	2	008510165
45	165	13,90	2	008510165
125	245	16,20	2	008510245

Beta

## 851SR

porta-pontas de desengate rápido com punho



L	L1	€	U	U
mm	mm			
230	110	19,10	2	008510001

## 852

porta-bits, com cabo articulado em T

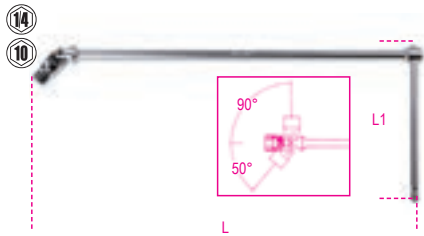

Ø	L	L1	€	U	U
mm	mm	mm			
1/4"	400	160	37,00	2	008520006
10 mm	400	160	37,00	2	008520010

## 855P

punho porta-pontas com roquete reversível, articulado, com 7 bits integrados

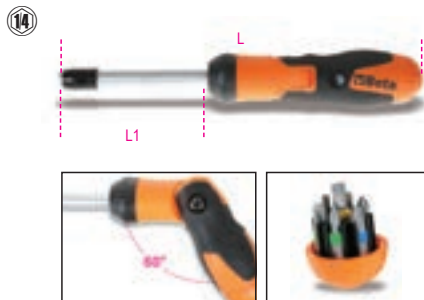

L	L1	€	U	U
mm	mm			
240	100	65,00	1	008550010

	860PH	PH1 - PH2
	860PZ	PZ1 - PZ2
	860LP	LP 0,8x5,5 mm
	860PE	4 - 5 mm

## 860LP

bits para parafusos ranhurados, coloridos



SxA	L	€	U	U
mm	mm			
0,5x3	25	1,70	5	008600005
0,6x4,5	25	1,70	5	008600010
0,8x5,5	25	1,70	5	008600015
1x5,5	25	1,70	5	008600020
1,2x6,5	25	1,70	5	008600025

## 860PH

bits para parafusos Phillips®, coloridos



ISO 2351-2  
ISO 1173 C 6,3

PH	L	€	U	U
	mm			
0	25	1,70	5	008600220
1	25	1,70	5	008600225
2	25	1,70	5	008600230
3	25	1,70	5	008600245
4	25	2,50	5	008600250

## 860PZ

bits para parafusos Pozidriv® - Supadriv®, coloridos



ISO 2351-2  
ISO 1173 C 6,3

PZ	L	€	U	U
	mm			
1	25	1,70	5	008600320
2	25	1,70	5	008600325
3	25	1,70	5	008600330
4	25	2,50	5	008600335

## 860PE

bits sextavados para aparafusadoras eléctricas, coloridos



ISO 2351-3  
ISO 1173 C 6,3

mm	L	€	U	U
	mm			
2	25	1,80	5	008600101
2,5	25	1,80	5	008600102
3	25	1,80	5	008600103
4	25	1,80	5	008600104
5	25	1,80	5	008600105
6	25	1,80	5	008600106
8	25	2,25	5	008600108
10	25	2,25	5	008600110

## 860TX

bits para parafusos Torx®, coloridos



ISO 1173 C 6,3

Ø	L	€	U	U
	mm			
T6	25	2,25	5	008600704
T7	25	2,25	5	008600705
T8	25	2,25	5	008600710
T9	25	2,25	5	008600715
T10	25	1,80	5	008600720
T15	25	1,80	5	008600725
T20	25	1,80	5	008600730
T25	25	1,80	5	008600735
T27	25	1,80	5	008600740
T30	25	1,80	5	008600745
T40	25	1,80	5	008600750

## 860RTX

bits para parafusos invioláveis Torx®, coloridos



ISO 1173 C 6,3

Ø	L	€	U	U
	mm			
T9	25	2,50	5	008600550
T10	25	2,50	5	008600555
T15	25	2,50	5	008600560
T20	25	2,50	5	008600565
T25	25	2,50	5	008600570
T27	25	2,50	5	008600575
T30	25	2,50	5	008600580
T40	25	2,50	5	008600585

## 860/55

chave de bits reversível



L	Ø	€	U	U
mm	mm			
100	1/4"	28,00	3	008600870

## 860/58

roquete com punho rotativo

- O bit encaixa em ambos os lados, para aparafusar ou desaparafusar
- Punho bi-material



L	Ø	A	€	U	U		
mm	mm	mm					
860/58	126	1/4"	27	15	65,00	1	008600884

## 860/C27

jogo de 25 bits, 1 conector e 1 roquete reversível em estojo de plástico



860/C27 € 77,50 1 008600880

	860/55	100 mm	
	860LP	0,5x3-1,0x5,5-1,2x6,5 mm	
	860PH	PH1-PH2(x2)-PH3	
	860PZ	PZ1-PZ2(x2)-PZ3	
	860PE	2-2,5-3-4-5-6 mm	
	860TX	T6-T8-T10-T15-T20-T25-T30-T40	
	892/0	● 1/4 ■ 1/4	

## 860PHZ/A10

jogo de 10 pontas com porta pontas magnético em caixa plástica



860PHZ/A10 € 32,50 1 008600910

	860PH	PH1 PH2 PH3	n. 1 3 1
	860PZ	PZ1 PZ2 PZ3	1 3 1
	882M1	○ 1/4 ● 1/4	

## 860PE/A10

jogo de 10 pontas com porta pontas magnético em caixa plástica



860PE/A10 € 34,00 1 008600920

	860PE	2 - 2,5 mm	n. 1
	882M1	3 - 4 - 5 - 6 mm ○ 1/4 ● 1/4	2

## 860TX/A10

jogo de 10 pontas com porta pontas magnético em caixa plástica



860TX/A10 € 34,50 1 008600970

	860TX	T7 - T8 - T9 - T10 - T15 - T20 T25 - T27 - T30 - T40	n. 1
	882M1	○ 1/4 ● 1/4	

## 860MIX/A10

jogo de 10 pontas com porta pontas magnético em caixa plástica



860MIX/A10 € 32,50 1 008600900

	860LP	0,5x3 - 1x5,5 - 1,2x6,5 mm	n. 1
	860PH	PH1 PH2 PH3	1 2 1
	860PZ	PZ1 - PZ2 - PZ3	1
	882M1	○ 1/4 ● 1/4	

## 860MIX/A31

jogo de 30 pontas com porta pontas magnético de desengate rápido em caixa plástica



860MIX/A31 € 76,50 1 008600902

	860LP	0,5x3 - 0,6x4 - 0,8x5,5 1,0x5,5 - 1,2x6,5 mm	
	860PE	2 - 2,5 - 3 - 4 - 5 - 6 8 - 10 mm	
	860PH	PH0 - PH1 - PH2 - PH3 - PH4	
	860PZ	PZ1 - PZ2 - PZ3 - PZ4	
	860RTX	T9 - T10 - T15 - T20 T25 - T27 - T30 - T40	
	882MSR/50	○ 1/4 ● 1/4	

## 860/C38P

1 punho porta-pontas com roquete reversível, 27 bits, 8 chaves de caixa sextavadas e 2 acessórios em estojo de metal com tabuleiro maleável

porta-pontas com roquete reversível  
tampa porta-bits  
barra de extensão amovível de montagem rápida



860/C38P € 169,00 1 008600878

	860LP	0,6x4,5 - 0,8x5,5 - 1,0x5,5 - 1,2x6,5 mm	
	860PE	2-2,5-3-4(x2)-5(x2)	
	860PH	PH1(x2)-PH2(x2)-PH3	
	860PZ	PZ1(x2)-PZ2(x2)-PZ3	
	860TX	T10-T15-T20-T25-T30-T40	
	900	5-5,5-6-7-8-9-10-13 mm	
	892/0	● 1/4 ■ 1/4	
	892/3	● 1/4 ■ 1/4	
	855P	240 mm	

270x120x45 mm

# Beta

## 861LP

pontas para parafusos de fenda



ISO 2351-1

ISO 1173 C 6,3

SxA mm	L mm	€	10	200	008610005
0,5x3	25	1,10	10	008610005	
0,6x4	25	1,10	10	008610007	
0,6x4,5	25	1,10	10	008610010	
0,8x5,5	25	1,10	10	008610015	
1x5,5	25	1,10	10	008610020	
1,2x6,5	25	1,10	10	008610025	
1,2x8	25	2,10	10	008610028	
1,6x8	25	2,10	10	008610030	

## 861PH

pontas para parafusos de perfil Phillips®



ISO 2351-2

ISO 1173 C 6,3

PH	L mm	€	10	200	008610200
0	25	1,10	10	008610200	
1	25	1,10	10	008610205	
2	25	1,10	10	008610210	
2L	50	2,10	10	008610213	
3	25	1,10	10	008610215	
4	25	2,90	10	008610220	

## 861PH/C

pontas para parafusos de perfil Phillips®



ISO 2351-2

ISO 1173 C 6,3

PH	L mm	€	200	008610250
0	25	0,80	200	008610250
1	25	0,80	200	008610255
2	25	0,80	200	008610260
2L	50	1,55	100	008610263
3	25	0,80	200	008610265
4	25	2,10	100	008610270

## 861PZ

pontas para parafusos de perfil Pozidriv® - Supadriv®



ISO 2351-2

ISO 1173 C 6,3

PZ	L mm	€	10	200	008610300
1	25	1,10	10	008610300	
2	25	1,10	10	008610305	
2L	50	2,10	10	008610308	
3	25	1,10	10	008610310	
4	25	2,90	10	008610315	

## 861PZ/C

pontas para parafusos de perfil Pozidriv® - Supadriv®



ISO 2351-2

ISO 1173 C 6,3

PZ	L mm	€	200	008610350
1	25	0,80	200	008610350
2	25	0,80	200	008610355
2L	50	1,55	100	008610358
3	25	0,80	200	008610360
4	25	2,10	100	008610365

## 861PE

pontas macho hexagonal



ISO 2351-3

ISO 1173 C 6,3

mm	L mm	€	10	008610100
2	25	1,15	10	008610100
2,5	25	1,15	10	008610105
3	25	1,15	10	008610110
4	25	1,15	10	008610115
5	25	1,15	10	008610120
6	25	1,15	10	008610125
8	25	1,75	10	008610130
10	25	2,30	10	008610135

## 861TX

pontas para parafusos de perfil Torx®



ISO 1173 C 6,3

mm	L mm	€	10	008610399
T5	25	1,55	10	008610399
T6	25	1,55	10	008610400
T7	25	1,55	10	008610405
T8	25	1,55	10	008610410
T9	25	1,55	10	008610415
T10	25	1,20	10	008610420
T15	25	1,20	10	008610425
T20	25	1,20	10	008610430
T25	25	1,20	10	008610435
T27	25	1,20	10	008610440
T30	25	1,20	10	008610445
T40	25	1,20	10	008610450

## 861TX/C

pontas para parafusos de perfil Torx®

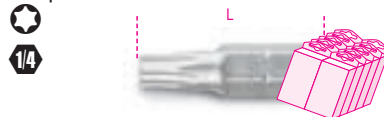

ISO 1173 C 6,3

mm	L mm	€	200	008610470
T10	25	0,90	200	008610470
T15	25	0,90	200	008610475
T20	25	0,90	200	008610480

mm	L mm	€	200	008610485
T25	25	0,90	200	008610485
T27	25	0,90	200	008610490
T30	25	0,90	200	008610495
T40	25	0,90	200	008610499

## 861RTX

pontas para parafusos de perfil Tamper Resistant Torx®



ISO 1173 C 6,3

mm	L mm	€	10	008610538
T7	25	2,25	10	008610538
T9	25	2,25	10	008610500
T10	25	2,25	10	008610505
T15	25	2,25	10	008610510
T20	25	2,25	10	008610515
T25	25	2,25	10	008610520
T27	25	2,25	10	008610525
T30	25	2,25	10	008610530
T40	25	2,25	10	008610535
T45	25	4,45	10	008610539

## 861RIBE

pontas para parafusos RIBE®



ISO 1173 C 6,3

mm	L mm	€	10	008610705
M5	25	1,00	10	008610705
M6	25	1,00	10	008610706
M7	25	1,20	10	008610707
M8	25	1,20	10	008610708
M9	25	1,75	10	008610709

## 861TRW

pontas para parafusos de perfil Tri-Wing®



ISO 1173 C 6,3

GR	L mm	€	10	008610601
1	25	1,90	10	008610601
2	25	1,90	10	008610602
3	25	1,90	10	008610603
4	25	1,90	10	008610604
5	25	1,90	10	008610605
6	25	2,75	10	008610606



## 861TQS

pontas para parafusos de perfil Torq-Set®



ISO 1173 C 6,3

GR	L mm	€	🔧	📦
0	25	1,90	10	008610620
1	25	1,90	10	008610621
2	25	1,90	10	008610622
3	25	1,90	10	008610623
4	25	1,90	10	008610624
5	25	1,90	10	008610625
6	25	1,90	10	008610626
8	25	1,90	10	008610628
10	25	1,90	10	008610630

## 861SP

pontas para parafusos de perfil Spanner

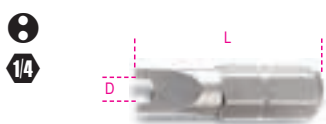

ISO 1173 C 6,3

SP	D mm	L mm	€	🔧	📦
4	1,5	25	1,55	10	008610650
6	2,4	25	1,55	10	008610653
8	2,8	25	1,55	10	008610656
10	3,3	25	1,55	10	008610658
12	3,9	25	1,55	10	008610660

## 1483KV-PT/S7



1483KV PT/S7

155

## 861XZN

pontas para parafusos XZN®



ISO 1173 C 6,3

Ø	L mm	€	🔧	📦
M5	25	1,00	10	008610725
M6	25	1,00	10	008610726
M8	25	1,20	10	008610728

## 861/C61P

61 pontas e 1 porta-pontas magnético de desengate rápido com punho



861/C61P 142,00 1 008610978

861LP	0,5x3 - 0,6x4,5 - 0,8x5,5 - 1,0x5,5 - 1,2x6,5 - 1,2x8 - 1,6x8 mm
861PE	2 - 2,5 - 3 - 4 - 5 - 6 - 8 - 10 mm
861PH	PH0 - PH1 - PH2 - PH3
861PZ	PZ1 - PZ2 - PZ3
861TX	T6 - T7 - T8 - T9 - T10 - T15 - T20 - T25 - T27 - T30 - T40
861RTX	T9 - T10 - T15 - T20 - T25 - T27 - T30 - T40
861TRW	1 - 2 - 3 - 4 - 5 - 6
861TQS	0 - 1 - 2 - 3 - 4 - 5 - 6 - 8 - 10
861SP	4 - 6 - 8 - 10 - 12
851SR	Ø 1/4"

270x120x45 mm - 975 g

## 862LP

pontas para parafusos de perfil de fenda



ISO 2351-1

ISO 1173 E 6,3

SxA mm	L mm	€	🔧	📦
0,5x3	50	3,20	5	008620005
0,6x4,5	50	3,20	5	008620010
0,8x5,5	50	3,20	5	008620015
1x5,5	50	3,20	5	008620020
1,2x6,5	50	3,20	5	008620025
1,2x8	50	3,95	5	008620030
1,6x8	50	3,95	5	008620035

## 862PH

pontas para parafusos de perfil Phillips®



ISO 2351-2

ISO 1173 E 6,3

PH	L mm	€	🔧	📦
1	50	3,20	5	008620200
2	50	3,20	5	008620205
3	50	3,20	5	008620210

## 862PH/L

pontas para parafusos de perfil Phillips®



ISO 2351-2

ISO 1173 E 6,3

PH	L mm	€	🔧	📦
1	70	5,85	5	008620230
2	70	5,85	5	008620232
3	70	5,85	5	008620234

## 862PH-XL

Pontas para parafusos de perfil Phillips®



ISO 2351-2ISO 1173 E 6,3

PH	L mm	€	🔧	📦
1	100	6,00	5	008620250
2	100	6,00	5	008620252
3	100	6,00	5	008620254

## 862PZ

pontas para parafusos de perfil Pozidriv® - Supadriv®



ISO 2351-2

ISO 1173 E 6,3

PZ	L mm	€	🔧	📦
1	50	3,30	5	008620300
2	50	3,30	5	008620305
3	50	3,30	5	008620310

## 862PE

pontas macho hexagonal



ISO 2351-3

ISO 1173 E 6,3

mm	L mm	€	🔧	📦
3	50	3,30	5	008620103
4	50	3,30	5	008620104
5	50	3,30	5	008620105
6	50	3,30	5	008620106
8	50	4,45	5	008620108

## 862TX

pontas para parafusos de perfil Torx®



ISO 1173 E 6,3

Ø	L mm	€	5	10
T9	50	4,35	5	008620509
T10	50	4,35	5	008620510
T15	50	4,35	5	008620515
T20	50	4,35	5	008620520
T25	50	4,35	5	008620525
T27	50	4,35	5	008620527
T30	50	4,35	5	008620530
T40	50	4,35	5	008620540

## 862TX/L

pontas para parafusos de perfil Torx®



ISO 1173 E 6,3

Ø	L mm	€	5	10
T9	70	4,75	5	008620559
T10	70	4,75	5	008620560
T15	70	4,75	5	008620565
T20	70	4,75	5	008620570
T25	70	4,75	5	008620575
T27	70	4,75	5	008620577
T30	70	4,75	5	008620580
T40	70	4,75	5	008620590

## 862TX-XL

Pontas para parafusos de perfil Torx®



ISO 1173 E 6,3

Ø	L mm	€	5	10
T9	100	5,15	5	008620659
T10	100	5,15	5	008620660
T15	100	5,15	5	008620665
T20	100	5,15	5	008620670
T25	100	5,15	5	008620675
T27	100	5,15	5	008620677
T30	100	5,15	5	008620680
T40	100	5,15	5	008620690

## 862F

pontas para chaves de caixa magnéticas



ISO 1173 E 6,3

mm	L mm	Ø mm	€	5	10
5,5	65	11	5,90	5	008620405
6	65	11	5,90	5	008620406
7	65	11	5,90	5	008620407
8	65	13	5,90	5	008620408
10	65	15	6,45	5	008620410
12	65	18	7,10	5	008620412
13	65	18	7,60	5	008620413

## 862F/A7

Jogo de 7 bits sextavados magnéticos com chaves de caixa sextavadas em estojo de plástico



862F/A7 € 45,00 1 008620950



## 866LP

pontas para parafusos de fendas



ISO 2351-1  
ISO 1173 C 8

SxA mm	L mm	€	5	10
1x5,5	41	3,30	10	008660005
1,2x6,5	41	3,30	10	008660010
1,6x8	41	3,30	10	008660015
1,6x10	41	4,40	10	008660020
2x12	41	5,45	10	008660025

## 866PH

pontas para parafusos de perfil Phillips®



ISO 2351-2

ISO 1173 C 8

PH	L mm	€	5	10
1	32	2,65	10	008660200
2	32	2,65	10	008660205
3	32	2,65	10	008660210
4	38	3,95	10	008660215

## 866PZ

pontas para parafusos de perfil Pozidriv® - Supadriv®



ISO 2351-2

ISO 1173 C 8

PZ	L mm	€	5	10
1	32	2,75	10	008660300
2	32	2,75	10	008660305
3	32	2,75	10	008660310
4	38	4,10	10	008660315

## 866PE

pontas macho hexagonal



ISO 2351-3

ISO 1173 C 8

mm	L mm	€	5	10
3	30	2,25	10	008660100
4	30	2,25	10	008660105
5	30	2,25	10	008660110
6	30	2,25	10	008660115
7	30	2,25	10	008660117
8	30	2,25	10	008660120
10	30	3,20	10	008660125
12	30	4,40	10	008660132
14	30	5,70	10	008660134

## 866TX

pontas para parafusos de perfil Torx®



ISO 1173 C 8

Ø	L mm	€	5	10
T20	30	2,85	10	008660400
T25	30	2,85	10	008660405
T27	30	2,85	10	008660410
T30	30	2,85	10	008660415
T40	30	2,85	10	008660420
T45	30	2,85	10	008660425
T50	30	2,85	10	008660430
T55	30	4,05	10	008660435
T60	30	5,45	10	008660440
T70	30	6,15	10	008660445

## 866RTX

pontas para parafusos de perfil Tamper Resistant Torx®



ISO 1173 C 8

Ø	L mm	€	5	10
T40	30	3,30	10	008660520
T45	30	3,30	10	008660525
T50	30	3,30	10	008660530
T55	30	4,60	10	008660535
T60	30	5,95	10	008660540
T70	30	7,35	10	008660545

## 867PE

pontas macho hexagonal

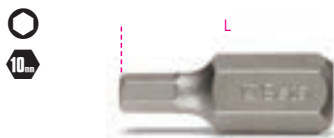

mm	L mm	€	🔧	📦
4	30	1,50	5	008670104
5	30	1,50	5	008670105
6	30	1,50	5	008670106
7	30	1,50	5	008670107
8	30	1,50	5	008670108
10	30	1,50	5	008670110
12	30	2,10	5	008670112

## 867PE/L

pontas hexagonais



mm	L mm	€	🔧	📦
4	75	2,65	5	008670154
5	75	2,65	5	008670155
6	75	2,65	5	008670156
7	75	2,65	5	008670157
8	75	2,65	5	008670158
10	75	2,65	5	008670160
12	75	3,75	5	008670162

## 867XZN

pontas para parafusos de perfil XZN®



mm	L mm	€	🔧	📦
M4	30	1,75	5	008670204
M5	30	1,75	5	008670205
M6	30	1,75	5	008670206
M8	30	1,75	5	008670208
M10	30	1,75	5	008670210
M12	30	2,65	5	008670212

## 867XZN/L

pontas com perfil XZN®

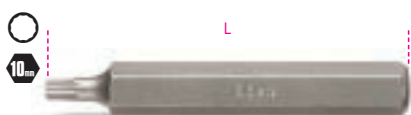

mm	L mm	€	🔧	📦
M5	75	2,95	5	008670255
M6	75	2,95	5	008670256
M8	75	2,95	5	008670258
M10	75	2,95	5	008670260
M12	75	4,05	5	008670262

## 867TX

pontas para parafusos de perfil Torx®



mm	L mm	€	🔧	📦
T20	30	1,50	5	008670400
T25	30	1,50	5	008670405
T30	30	1,50	5	008670410
T40	30	1,50	5	008670415
T45	30	1,50	5	008670420
T50	30	1,50	5	008670425
T55	30	1,50	5	008670430

## 867TX/L

pontas para parafusos de perfil Torx®



mm	L mm	€	🔧	📦
T20	75	2,35	5	008670450
T25	75	2,35	5	008670455
T30	75	2,35	5	008670460
T40	75	2,35	5	008670465
T45	75	2,35	5	008670470
T50	75	2,35	5	008670475
T55	75	2,35	5	008670480

## 867RTX

pontas para parafusos de perfil Tamper Resistant Torx®



mm	L mm	€	🔧	📦
T20	30	1,65	5	008670500
T25	30	1,65	5	008670505
T30	30	1,65	5	008670510
T40	30	1,65	5	008670515
T45	30	1,65	5	008670520
T50	30	1,65	5	008670525
T55	30	1,65	5	008670530

## 867RTX/L

pontas para parafusos de perfil Tamper Resistant Torx®



mm	L mm	€	🔧	📦
T20	75	2,75	5	008670550
T25	75	2,75	5	008670555
T30	75	2,75	5	008670560
T40	75	2,75	5	008670565
T45	75	2,75	5	008670570
T50	75	2,75	5	008670575
T55	75	2,75	5	008670580

## 867RIBE

pontas para parafusos RIBE®

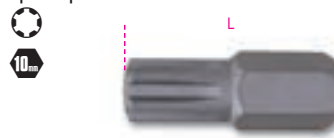

mm	L mm	€	🔧	📦
M5	30	1,60	5	008670705
M6	30	1,60	5	008670706
M7	30	1,60	5	008670707
M8	30	1,60	5	008670708
M9	30	1,60	5	008670709
M10	30	1,60	5	008670710
M11	30	2,35	5	008670711
M12	30	2,35	5	008670712
M13	30	2,35	5	008670713

## 867RIBE/L

pontas para parafusos de perfil RIBE®



mm	L mm	€	🔧	📦
M5	75	2,65	5	008670755
M6	75	2,65	5	008670756
M7	75	2,65	5	008670757
M8	75	2,65	5	008670758
M9	75	2,65	5	008670759
M10	75	2,65	5	008670760
M11	75	3,60	5	008670761
M12	75	3,60	5	008670762
M13	75	3,60	5	008670763

## 867/...

chaves de caixa porta-pontas para artigos 867

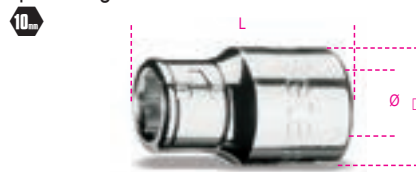

mm	mm	L mm	Ø mm	€	🔧	📦	
867/1	10	3/8"	38	17	5,15	5	008670600
867/2	10	1/2"	38	22	5,90	5	008670601

## 867/C20

jogo 18 bits para parafusos RIBE®, com encabadouro sextavado 10 mm e 2 acessórios



mm	€	🔧	📦
867/C20	101,00	1	008670920

	867RIBE	5-6-7-8-9-10-11-12-13 mm
	867RIBE/L	5-6-7-8-9-10-11-12-13 mm
	867/1	
	867/2	

📦 335x145x60 mm - 📦 1,7 kg



## 867/C38

Porta Bits com punho em T articulado, 38 sextavados 10 mm



867/C38 € 183,00 1 008670938

852	10 mm
867PE	4-5-6-7-8-10-12mm
867PE/L	4-5-6-7-8-10-12mm
867XZN	M5-M6-M8-M10-M12
867XZN/L	M5-M6-M8-M10-M12
867TX	T20-T25-T30-T40-T45-T50-T55
867TX/L	T20-T25-T30-T40-T45-T50-T55

882  
420x185x60 mm - 3 kg

## 867/C52

jogo com 52 pontas, com porta-pontas hexagonal de 10 mm e 2 acessórios

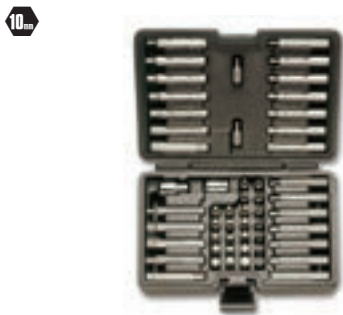

867/C52 € 118,00 1 008670901

867PE	4-5-6-7-8-10-12 mm
867PE/L	4-5-6-7-8-10-12 mm
867XZN	M5-M6-M8-M10-M12
867XZN/L	M5-M6-M8-M10-M12
867TX	T20-T25-T30-T40-T45-T50-T55
867TX/L	T20-T25-T30-T40-T45-T50-T55
867RTX	T20-T25-T30-T40-T45-T50-T55
867RTX/L	T20-T25-T30-T40-T45-T50-T55

867/1 ○ 10 mm - □ 3/8"  
867/2 ○ 10 mm - □ 1/2"

250x170x70 mm - 2,1 kg

## 882

porta-pontas com anel de retenção para aparafusadoras



ISO 1173 E 6,3

L mm ○ ● Ø mm € 5 008820001  
57 1/4 1/4 11 14,70

## 882M1

porta-pontas magnético



ISO 1173 E 6,3

L mm ○ ● Ø mm € 5 008820006  
50 1/4 1/4 11 15,30

## 882M

porta-pontas magnético



ISO 1173 E 6,3

L mm ○ ● Ø mm € 5 008820005  
75 1/4 1/4 11 18,60

## 882MSR

porta-pontas magnético com desengate rápido para aparafusadoras



ISO 1173 E 6,3

L mm ○ ● Ø mm € 5 008820205  
50 1/4 1/4 11 16,40  
75 1/4 1/4 11 19,10

## 882P

extensão para porta-bits magnético



L mm ○ ● Ø mm € 5 008820080  
80 1/4 1/4 10 13,60

## 892

adaptadores para aparafusadoras



892/0  
892/1  
892/2  
892/3  
892/4  
892/5  
892/6  
892/7

	■	●	L mm	€	5	008920000
892/0	1/4	1/4	25	4,80	5	008920000
* 892/1	1/4	5,5	50	8,95	5	008920001
* 892/2	3/8	5,5	50	13,60	5	008920002
* 892/3	1/4	1/4	50	8,95	5	008920003
° 892/4	3/8	1/4	50	13,70	5	008920004
892/5	1/4	5/16	75	12,60	5	008920005
892/6	3/8	5/16	75	18,60	5	008920006
892/7	1/2	1/4	75	19,10	5	008920007

\* ISO 1173 A 5,5  
° ISO 1173 C 6,3

## 895

chaves de caixa porta-pontas refª s. 861 - 862 - 866



DIN 7427

	○	□	L mm	Ø mm	€	5	008950000
895/1	1/4	1/4	25,4	12	10,80	5	008950000
895/3	1/4	3/8	29	16,8	12,90	5	008950001
895/4	5/16	3/8	29	16,8	12,90	5	008950002
895/5	1/4	1/2	38	22	12,90	5	008950005
895/6	5/16	1/2	38	22	12,90	5	008950003

## 897

porta-pontas flexível com punho



L mm L1 mm € 5 008970010  
280 154 24,20

## 897L

porta-pontas flexível com punho, modelo longo



L mm L1 mm € 5 008970015  
500 380 28,50



## 900

chaves de caixa, boca hexagonal



UNI/ISO 2725 DIN 3124

Ø mm	L mm	Ø1 mm	€	🔧	📄
4	6,8	25	3,70	10	009000040
4,5	7,4	25	3,70	10	009000045
5	8,0	25	3,70	10	009000050
5,5	8,7	25	3,70	10	009000055
6	9,3	25	3,70	10	009000060
7	10,4	25	3,70	10	009000070
8	11,8	25	3,70	10	009000080
9	12,7	25	3,70	10	009000090
10	14,2	25	3,70	10	009000100
11	15,8	25	3,70	10	009000110
12	17,2	25	3,70	10	009000120
13	18,0	25	3,70	10	009000130
14	20,0	25	3,70	10	009000140



900/SB13	€	🔧	📄
4-4,5-5-5,5-6-7-8-9-10-11-12-13-14 mm	62,00	1	009000150

## 900MB

chaves de caixa boca de 12 faces



UNI/ISO 2725 DIN 3124

Ø mm	L mm	Ø1 mm	€	🔧	📄
4	6,7	22	7,10	5	009000160
5	7,7	25	7,10	5	009000161
5,5	8,3	25	7,10	5	009000162
6	9,0	25	7,10	5	009000163
7	10,2	25	7,10	5	009000164
8	11,3	25	7,10	5	009000165
9	13,0	25	7,10	5	009000166
10	14,3	25	7,10	5	009000167
11	16,0	25	7,10	5	009000168
12	17,4	25	7,10	5	009000169
13	18,0	25	7,95	5	009000170
14	19,3	25	8,35	5	009000171



900MB/SB12	€	🔧	📄
4-5-5,5-6-7-8-9-10-11-12-13-14 mm	100,50	1	009000179

## 900L

chaves de caixa série longa, boca hexagonal



UNI/ISO 2725 DIN 3124

Ø mm	L mm	Ø1 mm	€	🔧	📄
4	6,5	50	8,55	5	009000181
4,5	7,0	50	8,55	5	009000182
5	7,5	50	8,55	5	009000183
5,5	8,5	50	8,55	5	009000184
6	9,5	50	8,55	5	009000185
7	10,5	50	8,55	5	009000186
8	12,0	50	8,55	5	009000187
9	13,0	50	8,55	5	009000188
10	14,0	50	8,95	5	009000189
11	16,0	50	8,95	5	009000190
12	17,5	50	8,95	5	009000191
13	17,5	50	8,95	5	009000192
14	20,0	50	8,95	5	009000193



900L/SB13	€	🔧	📄
4-4,5-5-5,5-6-7-8-9-10-11-12-13-14 mm	127,00	1	009000203

## 900MB/L

chaves de caixa série longa, boca de 12 faces



UNI/ISO 2725 DIN 3124

Ø mm	L mm	Ø1 mm	€	🔧	📄
5	8,0	50	13,10	3	009000211
6	9,3	50	13,10	3	009000212
7	10,9	50	13,10	3	009000213
8	11,6	50	13,10	3	009000214
9	13,0	50	13,10	3	009000215
10	14,3	50	14,00	3	009000216
11	16,0	50	14,00	3	009000217
12	17,4	50	14,00	3	009000218
13	18,0	50	14,00	3	009000219
14	19,0	50	14,00	3	009000220

## 900AS

chaves de caixa boca hexagonal



Ø mm	L mm	Ø1 mm	€	🔧	📄
5/32	8,8	25	4,00	5	009000349
3/16	7,7	25	4,00	5	009000340
7/32	8,8	25	4,00	5	009000345
1/4	9,6	25	4,00	5	009000350
9/32	10,2	25	4,00	5	009000355
5/16	11,3	25	4,00	5	009000360
11/32	12,7	25	4,00	5	009000365

Ø mm	L mm	Ø1 mm	€	🔧	📄
3/8	14,0	25	4,00	5	009000370
7/16	15,3	25	4,00	5	009000375
1/2	17,5	25	4,00	5	009000380
9/16	19,0	25	4,00	5	009000385



900AS/SB11	€	🔧	📄
3/16-7/32-5/32-1/4-9/32-5/16-11/32-3/8-7/16-1/2-9/16	56,50	1	009000389

## 900AS/MB

chaves de caixa, boca de 12 faces



SAE AS 954E

Ø "	L mm	Ø1 mm	€	🔧	📄
3/16	7,7	22	7,20	2	009000390
7/32	8,5	22	7,20	2	009000391
1/4	9,4	22	7,20	2	009000392
9/32	10,2	22	7,20	2	009000393
5/16	11,3	22	7,20	2	009000394
11/32	12,5	22	7,20	2	009000395
3/8	13,7	22	7,75	2	009000396
7/16	15,6	22	7,75	2	009000397
1/2	17,2	22	8,40	2	009000398
9/16	18,8	24	8,40	2	009000399

## 900AS/L

chaves de caixa série longa, boca hexagonal



Ø "	L mm	Ø1 mm	€	🔧	📄
3/16	7,0	50	9,00	2	009000301
7/32	8,5	50	9,00	2	009000303
1/4	9,8	50	9,00	2	009000305
9/32	10,5	50	9,00	2	009000307
5/16	12,0	50	9,00	2	009000309
11/32	13,0	50	9,00	2	009000311
3/8	14,0	50	9,00	2	009000313
7/16	16,0	50	9,00	2	009000315
1/2	17,5	50	9,00	2	009000317
9/16	20,0	50	9,50	2	009000319

## 900AS/MBL

chaves de caixa série longa, boca de 12 faces



Ø "	L mm	Ø1 mm	€	🔧	📄
5/32	6,8	50	13,90	2	009000325
3/16	8,0	50	13,90	2	009000326
7/32	8,5	50	13,90	2	009000327
1/4	9,8	50	13,90	2	009000328
9/32	10,9	50	13,90	2	009000329

"	Ø mm	L mm	Ø1 mm	€		
5/16	11,6	50	12,0	13,90	2	009000330
11/32	13,0	50	12,0	13,90	2	009000331
3/8	14,3	50	12,8	15,10	2	009000332
7/16	16,0	50	14,2	15,10	2	009000333
1/2	18,0	50	16,2	15,10	2	009000334
9/16	19,0	50	17,1	15,10	2	009000335

## 900FTX

chaves de caixa para parafusos com cabeça Torx®

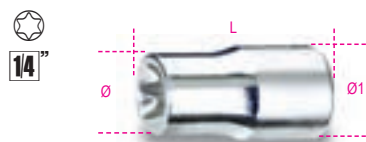

"	Ø mm	L mm	Ø1 mm	€		
E4	5,4	22	11,2	6,80	5	009000404
E5	6,7	22	11,2	6,80	5	009000405
E6	7,7	22	11,2	6,80	5	009000406
E7	8,3	22	11,2	6,80	5	009000407
E8	9,6	22	11,2	6,80	5	009000408
E10	11,3	22	12,0	6,80	5	009000410
E11	12,1	22	12,5	9,20	5	009000411
E12	12,9	23	12,9	9,20	5	009000412
E14	14,0	25	14,0	9,20	5	009000414



900FTX/SB9	€		
E4-E5-E6-E7-E8 E10-E11-E12-E14	79,50	1	009000419

## 900LP

chaves de caixa com ponta de perfil de fenda

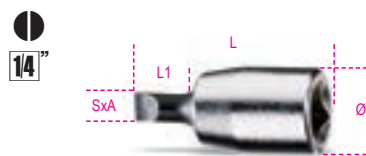

SxA mm	Ø mm	L mm	L1 mm	€		
0,8x4	12	28	9	8,30	5	009000605
1x5,5	12	28	9	8,30	5	009000610
1,2x6,5	12	28	9	8,30	5	009000615
1,2x8	13	28	8	8,30	5	009000620
1,6x10	14	28	8	8,30	5	009000625

## 900PH

chaves de caixa com ponta de perfil Phillips(R)



PH	Ø mm	L mm	L1 mm	€		
1	12	28	12	9,05	5	009000701
2	12	28	12	9,05	5	009000702
3	12	28	12	9,05	5	009000703
4	13	28	11	9,05	5	009000704

## 900ME

chaves de caixa com ponta macho hexagonal



mm	Ø mm	L mm	L1 mm	€		
2,5	12	25	4,5	7,80	5	009000502
3	12	25	5,0	7,80	5	009000503
4	12	25	5,6	7,80	5	009000504
5	12	25	6,3	7,80	5	009000505
6	12	25	7,6	7,80	5	009000506
7	13	25	7,2	7,80	5	009000507
8	13	25	8,0	7,80	5	009000508
10	13	25	8,7	9,60	5	009000510



900ME/SB8	€		
2,5-3-4-5-6-7-8-10 mm	74,50	1	009000518

## 900PT

chaves de caixa com pontas de 5 nervuras e furo central



PT	Ø mm	L mm	L1 mm	€		
PT10	12	28	12	16,40	5	009000750
PT15	12	28	12	16,40	5	009000755
PT20	12	28	12	16,40	5	009000760
PT25	12	28	12	16,40	5	009000765
PT27	12	28	12	16,40	5	009000767
PT30	12	28	12	16,40	5	009000770

## 900TX

chaves de caixa com ponta macho de perfil Torx(R)



T	Ø mm	L mm	L1 mm	€		
T8	12	28	12	12,30	5	009000719
T9	12	28	12	12,30	5	009000720
T10	12	28	12	12,30	5	009000721
T15	12	28	12	12,30	5	009000722
T20	12	28	12	12,30	5	009000723
T25	12	28	12	12,30	5	009000724
T27	12	28	12	12,30	5	009000725
T30	12	28	12	12,30	5	009000726
T40	12	28	12	12,30	5	009000727



900TX/SB8	€		
T9-T10-T15-T20 T25-T27-T30-T40	107,50	1	009000730

## 900/16

adaptador quadra fêmea de 1/4" para quadra macho de 3/8"



UNI/ISO 3316 DIN 3123

L mm	Ø mm	1/4"	3/8"	€		
28	13,0	1/4	3/8	6,25	5	009000814

## 900/...

extensões com quadras macho e fêmea de 1/4"

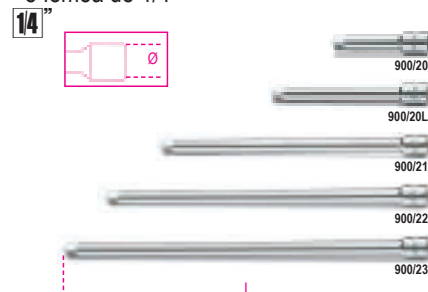

UNI/ISO 3316 DIN 3123

	L mm	Ø mm	€		
900/20	50	11,5	8,10	5	009000818
900/20L	100	11,5	8,30	5	009000819
900/21	150	11,5	8,65	5	009000822
900/22	250	11,5	12,70	5	009000823
900/23	350	11,5	15,30	5	009000824

## 900AN

extensões com quadras macho angulares e fêmea de 1/4"

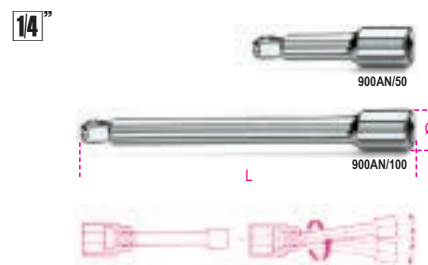

	L mm	Ø mm	€		
900AN/50	50	11,5	8,75	3	009000825
900AN/100	100	11,5	9,60	3	009000826

## 900FL

extensão flexível com quadras macho e fêmea de 1/4"



L	Ø	€	5	3
mm	mm			
150	12	12,60	5	009000828

## 900/25

cardan com quadras macho e fêmea de 1/4"



UNI/ISO 3316 DIN 3123

L	Ø	€	5	3
mm	mm			
41	12,5	15,70	5	009000830

## 900BG/30C

extensão 1/4" com punho, série curta



UNI/ISO 3315 DIN 3122

L	L1	€	5	3
mm	mm			
128	20	7,65	5	009000833

## 900BG/30

extensão 1/4" com punho



UNI/ISO 3315 DIN 3122

L	L1	€	5	3
mm	mm			
176	68	8,00	5	009000834

## 900/32

extensão flexível com punho quadra macho de 1/4"

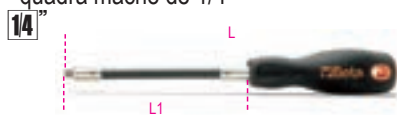

L	L1	€	5	3
mm	mm			
280	154	18,30	2	009000839

## 900/35A

cabo articulado com punho quadra de 1/4"

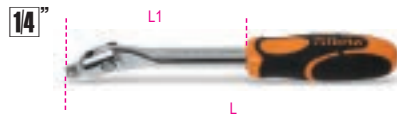

UNI/ISO 3315 DIN 3122

L	L1	€	5	3
mm	mm			
148	84	26,00	5	009000840

## 900M/35

cabo articulado com punho metálico quadra de 1/4"



UNI/ISO 3315  
DIN 3122

L	€	5	3
mm			
130	34,00	5	009000845

## 900/40

punho com cardan macho de 1/4"



L	L1	€	5	3
mm	mm			
390	145	35,00	5	009000843

## 900/42

cabo T corredeço, quadra de 1/4"



UNI/ISO 3315 DIN 3122

L	A	€	5	3
mm	mm			
115	22	8,75	5	009000854

## 900T/44

chave macho quadra 1/4" com punho



L	L1	€	5	3
mm	mm			
238	105	13,00	2	009000860

## 900/55

roquete reversível quadra de 1/4"  
48 dentes



UNI/ISO 3315 DIN 3122

L	Ø	A	€	5	3
mm	mm	mm			
125	25	18	42,00	5	009000870

## 900M/55

roquete reversível com punho metálico quadra de 1/4"



UNI/ISO 3315  
DIN 3122

L	Ø	A	€	5	3
mm	mm	mm			
110	22	18	54,00	3	009000905

Ver quadro depois do artigo 929/C8  
para acessórios compatíveis usados

## 900/58

roquete reversível quadra de 1/4"  
com punho rotativo,  
52 dentes

- Funcionamento através de punho rotativo
- Botão de desbloqueio da chave de caixa
- Sistema de inversão através de porca na cabeça do roquete
- Punho bi-material



L	Ø	A	€	5	3
mm	mm	mm			
126	28	28,5	64,00	2	009000884

## 900/C39

jogo de 11 chaves de caixa sextavadas 21 bits e 7 acessórios

1/4"

1/4"



900/C39 € 180,00 1 009000937

	861LP	0,6x4,5 - 1,2x6,5 - 1,2x8 mm
	861PH	PH1-PH2-PH3
	861PZ	PZ1-PZ2-PZ3
	861PE	2,5-3-4-5-6 mm
	861RTX	T10-T15-T20-T25-T27-T30-T40
	900	5-5,5-6-7-8-9-10-11-12-13-14 mm
	900/20	50 mm
	900/20L	100 mm
	900/25	
	900BG/30C	
	900/55	
	892/0	
	895/1	

## 900/C11

jogo com 11 chaves de caixa sextavadas, 20 pontas e 8 acessórios

1/4"

1/4"



900/C11 € 198,00 1 009000971

	861LP	0,5x3 - 0,8x5,5 1x5,5 - 1,2x6,5 mm
	861PE	3 - 4 - 5 - 6 - 8 mm
	861PH	0 - 1 - 2 - 3
	861TX	T8 - T10 - T15 - T20 T25 - T30 - T40
	895/1	
	900	5 - 5,5 - 6 - 7 - 8 - 9 - 10 11 - 12 - 13 - 14 mm
	900/16	□ 1/4 - ■ 3/8
	900/20	50 mm
	900/21	150 mm
	900/25	
	900BG/30	
	900/42	
	900/55	

270x120x45 mm - 1,2 kg

## 900/C13-5

jogo com 13 chaves hexagonais e 5 acessórios

1/4"



900/C13-5 € 157,00 1 009000953

	900	4 - 4,5 - 5 - 5,5 - 6 - 7 - 8 - 9 10 - 11 - 12 - 13 - 14 mm
	900/21	150 mm
	900/25	
	900BG/30	
	900/42	
	900/55	

270x120x45 mm - 1 kg

## 900/C13-8

jogo com 13 chaves hexagonais e 8 acessórios

1/4"



900/C13-8 € 197,00 1 009000954

	900	4 - 4,5 - 5 - 5,5 - 6 - 7 - 8 - 9 10 - 11 - 12 - 13 - 14 mm
	900/16	□ 1/4 - ■ 3/8
	900/20	50 mm
	900/21	150 mm
	900/25	
	900BG/30	
	900/35A	
	900/42	
	900/55	

270x120x45 mm - 1,1 kg

## 900MB/C19

jogo com 11 chaves de caixa de 12 faces e 8 acessórios

1/4"



900MB/C19 € 229,00 1 009000977

	900MB	5 - 5,5 - 6 - 7 - 8 - 9 - 10 - 11 12 - 13 - 14 mm
	900/16	□ 1/4 - ■ 3/8
	900/20	50 mm
	900/21	150 mm
	900/25	
	900BG/30	
	900/35A	
	900/42	
	900/55	

270x120x45 mm - 1,1 kg

## 900/C24

jogo com 13 chaves de caixa hexagonais, 11 pontas e 6 acessórios

1/4"



900/C24 € 256,00 1 009000956

	900	4 - 4,5 - 5 - 5,5 - 6 - 7 - 8 - 9 10 - 11 - 12 - 13 - 14 mm
	900LP	0,8x4 - 1,2x6,5 - 1,2x8 mm
	900PH	PH1 - PH2 - PH3
	900ME	3 - 4 - 5 - 6 - 8 mm
	900/20	50 mm
	900/21	150 mm
	900/25	
	900BG/30	
	900/42	
	900/55	

270x120x45 mm - 1,1 kg

## 900MB/C28

jogo com 11 chaves de caixa de 12 faces, 11 pontas e 6 acessórios

14"



900MB/C28 € 288,00 1 009000979

- 900MB 5-5,5-6-7-8-9-10-11-12-13-14 mm
- 900LP 0,8x4 - 1,2x6,5 - 1,2x8 mm
- ⊕ 900PH PH1 - PH2 - PH3
- 900ME 3-4-5-6-8 mm
- 900/20 50 mm
- 900/21 150 mm
- 900/25
- 900BG/30
- 900/42
- 900/55

270x120x45 mm - 1,1 kg

## 900AS/C10 - /MB-C17

jogo com 10 chaves de caixa e 7 acessórios

14"



900AS/C10 € 183,00 1 009000961

- 900AS 3/16 - 7/32 - 1/4 - 9/32 - 5/16 - 11/32 - 3/8 - 7/16 - 1/2 - 9/16
- 900/20 50 mm
- 900/21 150 mm
- 900/25
- 900BG/30
- 900/35A
- 900/42
- 900/55

270x120x45 mm - 1,1 kg

900AS/MB-C17 € 219,00 1 009000981

- 900AS/MB 3/16 - 7/32 - 1/4 - 9/32 - 5/16 - 11/32 - 3/8 - 7/16 - 1/2 - 9/16
- 900/20 50 mm
- 900/21 150 mm
- 900/25
- 900BG/30
- 900/35A
- 900/42
- 900/55

270x120x45 mm - 1,1 kg

## 900AS/C17-MBM

jogo com 10 chaves de caixa com 12 faces e 7 acessórios

14"



900AS/C17-MBM € 239,00 1 009000982

- 900AS/MB 3/16 - 7/32 - 1/4 - 9/32 - 5/16 - 11/32 - 3/8 - 7/16 - 1/2 - 9/16
- 900/20 50 mm
- 900/21 150 mm
- 900/25
- 900BG/30
- 900M/35
- 900/42
- 900M/55

270x120x45 mm - 1,2 kg

## 900/C11HR

11 chaves de caixa sextavadas, 20 bits e 7 acessórios, em estojo metálico com tabuleiro rígido

• roquete com punho rotativo

14"

14"



900/C11HR € 220,00 1 009000980

- 861LP 0,5x3-0,8x5,5-1x5,5-1,2x6,5 mm
- ⊕ 861PH PH0-PH1-PH2-PH3
- 861PE 3-4-5-6-8 mm
- 861TX T8-T10-T15-T20-T25-T30-T40
- 895/1
- 900 5-5,5-6-7-8-9-10-11-12-13-14 mm
- 900/16 □ 1/4 - ■ 3/8
- 900/20 50 mm
- 900/21 150 mm
- 900/25
- 900/42
- 900/30
- 900/58

350x150x50 mm - 1,3 kg

## 902R/C6

jogo de 6 conversores de quadra para chaves de caixa



902R/C6 € 83,50 1 009020814

- 900/16 □ 1/4 - ■ 3/8
- 910/15 □ 3/8 - ■ 1/4
- 910/16 □ 3/8 - ■ 1/2
- 920/15 □ 1/2 - ■ 3/8
- 920/16 □ 1/2 - ■ 3/4
- 928/15 □ 3/4 - ■ 1/2

170x100x35 mm - 600 g

## 910A

chaves de caixa, boca hexagonal

3/8"

3/8"



UNI/ISO 2725 DIN 3124

mm	Ø mm	L mm	Ø1 mm	€		
6	9,5	28	16,7	6,25	5	009100006
7	10,7	28	16,7	6,25	5	009100007
8	12,1	28	16,7	6,25	5	009100008
9	13,2	28	16,7	6,25	5	009100009
10	14,6	29	16,7	6,25	5	009100010
11	15,8	29	16,7	6,25	5	009100011
12	17,2	30	17,7	6,55	5	009100012
13	18,4	31	17,0	6,55	5	009100013
14	19,7	32	17,5	6,55	5	009100014
15	20,9	32	18,0	6,55	5	009100015
16	22,2	33	18,5	7,35	5	009100016
17	23,2	33	19,0	7,35	5	009100017
18	24,7	34	20,0	7,35	5	009100018
19	25,8	35	21,0	7,35	5	009100019
20	27,2	35	22,0	7,75	5	009100020
21	28,2	36	23,0	7,75	5	009100021
22	29,7	37	24,0	8,10	5	009100022

3/8"

3/8"



910A/SB17 € 135,00 1 009100030

6-7-8-9-10-11-12  
13-14-15-16-17  
18-19-20-21-22 mm

## 910B

chaves de caixa, boca de 12 faces

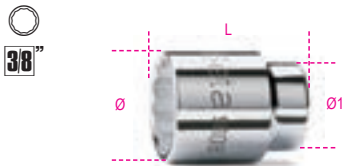

UNI/ISO 2725 DIN 3124

Ø mm	Ø mm	L mm	Ø1 mm	€	U	PC
6	9,5	28	16,7	6,25	5	009100106
7	10,7	28	16,7	6,25	5	009100107
8	12,1	28	16,7	6,25	5	009100108
9	13,2	28	16,7	6,25	5	009100109
10	14,6	29	16,7	6,25	5	009100110
11	15,8	29	16,7	6,25	5	009100111
12	17,2	30	17,7	6,55	5	009100112
13	18,4	31	17,0	6,55	5	009100113
14	19,7	32	17,5	6,55	5	009100114
15	20,9	32	18,0	6,55	5	009100115
16	22,2	33	18,5	7,35	5	009100116
17	23,2	33	19,0	7,35	5	009100117
18	24,7	34	20,0	7,35	5	009100118
19	25,8	35	21,0	7,35	5	009100119
20	27,2	35	22,0	7,75	5	009100120
21	28,2	36	23,0	7,75	5	009100121
22	29,7	37	24,0	8,10	5	009100122



<b>910B/SB17</b>	€ 135,00	U 1	PC 009100130
6-7-8-9-10-11-12			
13-14-15-16-17			
18-19-20-21-22 mm			

## 910AL

chaves de caixa série longa,  
boca hexagonal



UNI/ISO 2725 DIN 3124

Ø mm	Ø mm	L mm	Ø1 mm	€	U	PC
8	12,0	55	17	12,40	3	009100158
9	13,0	55	17	12,40	3	009100159
10	14,5	55	17	12,40	3	009100160
11	16,0	55	17	12,40	3	009100161
12	17,0	55	17	12,40	3	009100162
13	18,0	55	17	13,50	3	009100163
14	20,0	55	18	13,50	3	009100164
15	21,0	55	20	13,50	3	009100165
16	22,0	55	20	13,50	3	009100166
17	23,5	55	22	13,50	3	009100167
18	24,5	55	23	14,80	2	009100168
19	25,0	55	24	14,80	2	009100169
21	27,0	65	26	15,90	2	009100171
22	29,0	65	28	15,90	2	009100172



<b>910AL/SB14</b>	€ 206,00	U 1	PC 009100174
8-9-10-11-12-13-14			
15-16-17-18-19-21-22 mm			

## 910BL

chaves de caixa série longa,  
boca de 12 faces



UNI/ISO 2725 DIN 3124

Ø mm	Ø mm	L mm	Ø1 mm	€	U	PC
8	12,0	55	17	12,40	3	009100308
9	13,0	55	17	12,40	3	009100309
10	14,5	55	17	12,40	3	009100310
11	16,0	55	17	12,40	3	009100311
12	17,0	55	17	12,40	3	009100312
13	18,0	55	17	13,50	3	009100313
14	20,0	55	18	13,50	3	009100314
15	21,0	55	20	13,50	3	009100315
16	22,0	55	20	13,50	3	009100316
17	23,5	55	22	13,50	3	009100317
18	24,5	55	23	14,80	2	009100318
19	25,0	55	24	14,80	2	009100319
21	27,0	65	26	15,90	2	009100321
22	29,0	65	28	15,90	2	009100322



<b>910BL/SB14</b>	€ 206,00	U 1	PC 009100340
8-9-10-11-12-13			
14-15-16-17-18			
19-21-22 mm			

## 910B/SN

chaves de caixa articuladas  
com boca de 12 faces

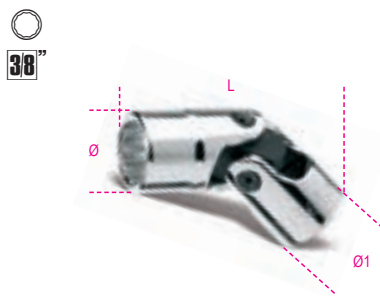

Ø mm	Ø mm	L mm	Ø1 mm	€	U	PC
10	14,5	48,5	19	32,00	2	009100230
11	15,8	49,5	19	32,00	2	009100231
12	17,0	50,0	19	32,00	2	009100232
13	18,3	51,0	19	32,00	2	009100233
14	19,5	51,0	19	35,50	2	009100234
15	20,8	53,5	19	35,50	2	009100235
16	22,0	53,5	19	35,50	2	009100236
17	23,3	54,5	19	35,50	2	009100237
18	24,5	54,5	19	35,50	2	009100238
19	25,8	56,5	19	35,50	2	009100239

**Beta**

## 910A/AS

chaves de caixa, boca hexagonal



Ø mm	Ø mm	L mm	Ø1 mm	€	U	PC
1/4	10,3	26	17,3	7,55	5	009100276
5/16	11,9	26	17,3	7,55	5	009100278
11/32	13,3	26	17,3	7,55	5	009100279
3/8	13,9	26	17,3	7,55	5	009100280
7/16	15,8	26	17,3	7,55	5	009100281
1/2	17,9	26	17,3	7,85	5	009100283
9/16	19,5	27	18,5	7,85	5	009100284
19/32	20,6	27	19,5	7,85	5	009100285
5/8	21,9	28	20,0	8,40	5	009100286
11/16	24,6	30	22,5	8,40	5	009100287
3/4	25,9	30	23,5	8,40	5	009100289
13/16	27,9	32	26,0	9,30	5	009100291
7/8	29,6	32	26,5	9,95	5	009100292



<b>910A-AS/SB13</b>	€ 121,00	U 1	PC 009100295
1/4-5/16-11/32-3/8-7/16			
1/2-9/16-19/32-5/8-11/16			
3/4-13/16-7/8			

## 910AS

chaves de caixa, boca de 12 faces

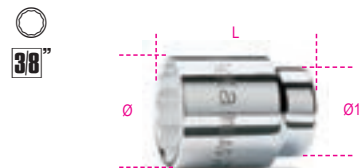

Ø mm	Ø mm	L mm	Ø1 mm	€	U	PC
1/4	9,5	28	16,7	7,55	5	009100201
5/16	12,1	28	16,7	7,55	5	009100202
11/32	13,2	28	16,7	7,55	5	009100203
3/8	14,6	29	16,7	7,55	5	009100204
7/16	15,8	29	16,7	7,55	5	009100205
1/2	18,4	31	17,0	7,85	5	009100206
9/16	19,7	32	17,5	7,85	5	009100207
19/32	20,9	32	18,0	7,85	5	009100208
5/8	22,2	33	18,5	8,40	5	009100209
11/16	24,7	34	20,0	8,40	5	009100210
3/4	25,8	35	21,0	8,40	5	009100211
13/16	28,2	36	23,0	9,30	5	009100212
7/8	29,7	37	24,0	9,95	5	009100213



<b>910AS/SB13</b>	€ 121,00	U 1	PC 009100215
1/4-5/16-11/32-3/8-7/16			
1/2-9/16-19/32-5/8-11/16			
3/4-13/16-7/8			

## 910AS/L

chaves de caixa série longa,  
boca de 12 faces

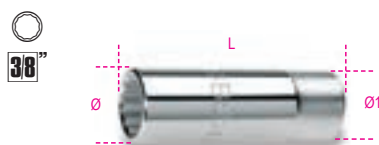

mm	Ø mm	L mm	Ø1 mm	€	Hand	Computer
1/4	10	55	17	15,30	3	009100350
5/16	12	55	17	15,30	3	009100351
3/8	14	55	17	15,30	3	009100352
7/16	16	55	17	15,30	3	009100353
1/2	18	55	17	16,90	3	009100354
9/16	20	55	18	16,90	3	009100355
19/32	21	55	20	17,50	3	009100356
5/8	22	55	20	17,50	3	009100357
11/16	23	55	22	17,50	3	009100359
3/4	25	55	24	18,60	3	009100360
13/16	27	65	26	21,80	3	009100362
7/8	29	65	28	21,80	3	009100363



910ASL/SB12	€	Hand	Computer
1/4-5/16-3/8-7/16 1/2-9/16-19/32-5/8-11/16 3/4-13/16-7/8	224,00	1	009100365

## 910AS/SN

chaves de caixa articuladas  
com boca de 12 faces



\* SAE AS 954E

mm	Ø mm	L mm	Ø1 mm	€	Hand	Computer
* 3/8	14,0	48,0	19	35,00	2	009100260
* 7/16	15,8	51,0	19	35,00	2	009100261
* 1/2	18,3	51,0	19	35,00	2	009100262
* 9/16	19,5	51,0	19	35,50	2	009100263
* 5/8	22,0	53,5	19	35,50	2	009100264
11/16	24,5	54,5	19	38,00	2	009100265
3/4	25,8	56,5	19	38,00	2	009100266

## 910FTX

chaves de caixa para parafusos  
de perfil Torx®

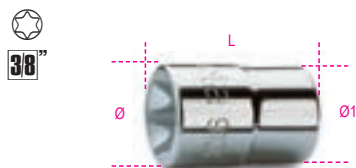

mm	Ø mm	L mm	Ø1 mm	€	Hand	Computer
E4	6,2	26	17,3	8,30	5	009100404
E5	7,0	26	17,3	8,30	5	009100405
E6	8,3	26	17,3	8,30	5	009100406
E7	8,9	26	17,3	8,30	5	009100407
E8	9,9	26	17,3	8,30	5	009100408
E10	12,0	26	17,3	8,30	5	009100410
E12	14,5	26	17,3	8,30	5	009100412
E14	15,8	26	17,3	8,30	5	009100414
E16	18,0	26	17,3	8,30	5	009100416



910FTX/SB9	€	Hand	Computer
E4-E5-E6-E7-E8 E10-E12-14-E16	86,00	1	009100430

## 910FTX/L

chaves de caixa série longa  
para parafusos de perfil Torx®



mm	Ø mm	L mm	Ø1 mm	€	Hand	Computer
E4	6,2	55	17,3	18,60	3	009100440
E5	7,0	55	17,3	18,60	3	009100441
E6	8,3	55	17,3	18,60	3	009100442
E7	8,9	55	17,3	18,60	3	009100443
E8	9,9	55	17,3	18,60	3	009100444
E10	12,0	55	17,3	18,60	3	009100445



910FTX-L/SB6	€	Hand	Computer
E4-E5-E6 E7-E8-E10	120,00	1	009100449

## 910LP

chaves de caixa com ponta  
de perfil de fenda



SxA mm	Ø mm	L mm	L1 mm	€	Hand	Computer
1x5,5	18,5	54	24	14,70	2	009100452
1,2x6,5	18,5	54	24	14,70	2	009100453
1,2x8	18,5	54	24	14,70	2	009100454
1,6x9	18,5	54	24	14,70	2	009100456

## 910PH

chaves de caixa com ponta  
de perfil Phillips®



PH mm	Ø mm	L mm	L1 mm	€	Hand	Computer
1	18,5	48	18	13,60	2	009100471
2	18,5	48	18	13,60	2	009100472
3	18,5	48	18	13,60	2	009100473
4	18,5	48	18	13,60	2	009100474

## 910PE

chaves de caixa com ponta  
macho hexagonal



DIN 7422

mm	Ø mm	L mm	L1 mm	€	Hand	Computer
3	18,5	50	20	11,70	5	009100490
4	18,5	50	20	11,70	5	009100492
5	18,5	50	20	11,70	5	009100494
6	18,5	50	20	11,70	5	009100496
7	18,5	50	20	11,70	5	009100497
8	18,5	50	20	11,70	5	009100498
10	18,5	50	20	11,70	5	009100500



910PE/SB7	€	Hand	Computer
3-4-5-6-7-8-10 mm	90,50	1	009100503

## 910BP

Chaves de caixa com ponta macho sextavada



mm	L mm	L1 mm	€	Hand	Computer
4L	92	62	14,10	3	009100584
5L	92	62	14,10	3	009100585
6L	92	62	14,10	3	009100586
7L	92	62	14,10	3	009100587
8L	92	62	14,10	3	009100588
10L	132	102	15,30	3	009100590

## 910ME

chaves de caixa com ponta  
macho hexagonal



mm	Ø mm	L mm	L1 mm	€	Hand	Computer
4	18	62	15	14,20	5	009100504
5	18	62	15	14,20	5	009100505
6	18	62	15	14,20	5	009100506
7	18	62	15	14,40	5	009100507
8	19	62	15	14,40	5	009100508
10	20	62	15	14,40	5	009100510
12	20	62	15	14,40	5	009100512



910ME/SB5	€	Hand	Computer
4-5-6-8-10 mm	78,50	1	009100515



## 910PT

chaves de caixa com pontas de 5 nervuras e furo central

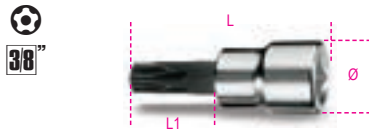

	Ø mm	L mm	L1 mm	€	U	IT
PT40	20	50	20	18,60	3	009100540
PT45	20	50	20	19,10	3	009100545
PT50	20	50	20	22,40	3	009100550



	€	U	IT
910PT/SB8 PT10-PT15-PT20-PT25 PT30-PT40-PT45-PT50	152,00	1	009100558

## 910TX

chaves de caixa com ponta macho de perfil Torx®



	Ø mm	L mm	L1 mm	€	U	IT
T15	18,5	50	20	15,70	5	009100519
T20	18,5	50	20	15,70	5	009100520
T25	18,5	50	20	15,70	5	009100521
T27	18,5	50	20	15,70	5	009100522
T30	18,5	50	20	15,70	5	009100523
T40	18,5	50	20	15,70	5	009100524



	€	U	IT
910TX/SB6 T15-T20-T25 T27-T30-T40	102,50	1	009100530

## 910CF

chaves pé de galo quadra fêmea de 3/8"



	A mm	L mm	€	U	IT
10	21,3	32,3	9,85	2	009100135
11	23,1	34,3	9,85	2	009100136
12	25,5	36,2	11,40	2	009100137
13	26,9	37,4	11,40	2	009100138
14	30,2	40,0	12,00	2	009100139
15	33,3	41,3	12,60	2	009100140
16	33,3	41,3	13,70	2	009100141
17	38,1	46,5	15,90	2	009100142
18	38,1	46,5	15,90	2	009100143
19	39,6	48,0	16,90	2	009100144



	€	U	IT
910CF/SB10 10-11-12-13-14-15 16-17-18-19 mm	142,00	1	009100147

## 910/15

redução quadra fêmea de 3/8"  
para quadra macho de 1/4"



UNI/ISO 3316 DIN 3123

L mm	Ø mm	□	■	€	U	IT
30	17,0	3/8	1/4	8,65	5	009100810



Aplique sempre uma força de aperto regular e progressiva, a fim de evitar a ruptura do material e de se proteger de um possível acidente

## 910/16

adaptador quadra fêmea de 3/8"  
para quadra macho de 1/2"



UNI/ISO 3316 DIN 3123

L mm	Ø mm	□	■	€	U	IT
32	18,0	3/8	1/2	9,05	5	009100814

## 910/20 - 910/21 - 910/22

extensões com quadras macho e fêmea de 3/8"

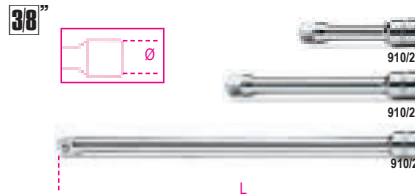

UNI/ISO 3316 DIN 3123

	L mm	Ø mm	€	U	IT
910/20	75	17	7,45	5	009100820
910/21	125	17	10,70	5	009100822
910/22	250	17	14,20	5	009100826

## 910AN

extensões com quadras macho angulares e fêmea de 3/8"

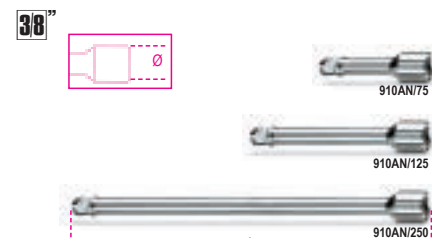

	L mm	Ø mm	€	U	IT
910AN/75	75	17	10,40	3	009100827
910AN/125	125	17	13,10	3	009100828
910AN/250	250	17	19,70	3	009100829

## 910/25

cardan com quadras macho e fêmea de 3/8"



UNI/ISO 3316 DIN 3123

L mm	Ø mm	€	U	IT
54,6	19	19,50	5	009100830

## 910M/35

cabo articulado com punho metálico, quadra de 3/8"



UNI/ISO 3315 DIN 3122

L mm	€	U	IT
250	53,50	3	009100839

## 910/36A

cabo articulado com punho quadra de 3/8"



UNI/ISO 3315 DIN 3122

L mm	L1 mm	€	U	IT
255	154	37,50	3	009100845

## 910/40

extensão articulada com punho em T quadra de 3/8"

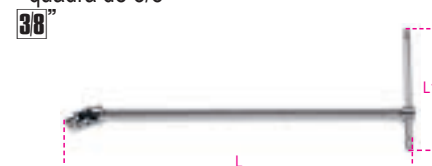

L mm	L1 mm	€	U	IT
420	175	40,50	3	009100850

Beta

## 910/42

cabo T corrediço, quadra de 3/8"

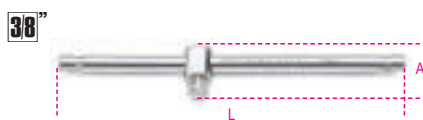

UNI/ISO 3315 DIN 3122

L	A	€	5	009100854
mm	mm			
210	30,5	12,60		

## 910/46

manivela quadra macho de 3/8"

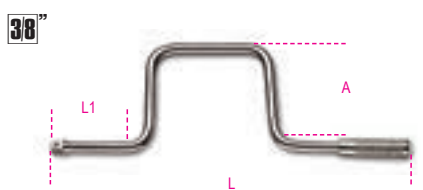

UNI/ISO 3315 DIN 3122

L	L1	A	€	1	009100862
mm	mm	mm			
315	80	115	25,00		

## 910/55

roquete reversível, quadra de 3/8"  
72 dentes



UNI/ISO 3315 DIN 3122

L	Ø	A	€	3	009100882
mm	mm	mm			
200	30	33	46,00		

## 910/55Q

roquete reversível, quadra de 3/8"  
48 dentes



UNI/ISO 3315 DIN 3122

L	Ø	A	€	3	009100885
mm	mm	mm			
200	30	33	46,00		

Ver quadro depois do artigo 929/C8  
para acessórios compatíveis usados

## 910M/55

roquete reversível com punho metálico  
quadra de 3/8"



L	Ø	A	€	2	009100875
mm	mm	mm			
178	30	26	63,50		

## 910M/56

roquete reversível articulado  
com punho metálico, quadra de 3/8"



L	Ø	A	€	2	009100887
mm	mm	mm			
265	31	29	85,50		

## 910/58

roquete reversível quadra 3/8"  
com punho rotativo,  
52 dentes

- Funcionamento através de punho rotativo
- Botão de desbloqueio da chave de caixa
- Sistema de inversão através de porca na cabeça do roquete
- Punho bi-material

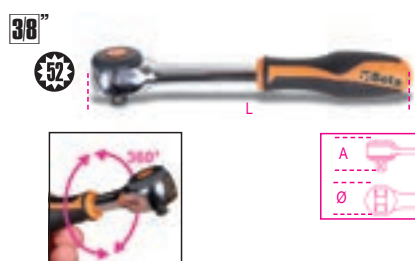

L	Ø	A	€	1	009100884
mm	mm	mm			
222	37	38,5	70,00		

## 910.../C10

jogo com 10 chaves de caixa  
e 2 acessórios



910A/C10	148,00	1	009100909
----------	--------	---	-----------

- 910A 6 - 7 - 8 - 10 - 11 - 12  
13 - 14 - 17 - 19 mm
- 910/21 125 mm
- 910/55

270x120x45 mm - 1,3 kg

910B/C10	148,00	1	009100910
----------	--------	---	-----------

- 910B 6 - 7 - 8 - 10 - 11 - 12  
13 - 14 - 17 - 19 mm
- 910/21 125 mm
- 910/55

270x120x45 mm - 1,3 kg

## 910A/C16...

jogo com 16 chaves de caixa de 12 faces  
e 5 acessórios



910A/C16	243,00	1	009100936
----------	--------	---	-----------

- 910A 6 - 7 - 8 - 9 - 10 - 11 - 12 - 13  
14 - 15 - 16 - 17 - 18 - 19  
21 - 22 mm
- 910/21 125 mm
- 910/22 250 mm
- 910/25
- 910/42
- 910/55

335x145x60 mm - 2,3 kg

910A/C16Q	243,00	1	009100932
-----------	--------	---	-----------

- 910A 6 - 7 - 8 - 9 - 10 - 11 - 12 - 13  
14 - 15 - 16 - 17 - 18 - 19  
21 - 22 mm
- 910/21 125 mm
- 910/22 250 mm
- 910/25
- 910/42
- 910/55Q

335x145x60 mm - 2,3 kg

# Beta

## 910B/C16...

jogo com 16 chaves de caixa de 12 faces e 5 acessórios

38"



910B/C16 € 243,00 1 009100937

- 910B 6 - 7 - 8 - 9 - 10 - 11 - 12 - 13  
14 - 15 - 16 - 17 - 18 - 19  
21 - 22 mm
  - 910/21 125 mm
  - 910/22 250 mm
  - 910/25
  - 910/42
  - 910/55
- ≡ 335x145x60 mm - 2,3 kg

910B/C16Q € 243,00 1 009100933

- 910B 6 - 7 - 8 - 9 - 10 - 11 - 12 - 13  
14 - 15 - 16 - 17 - 18 - 19  
21 - 22 mm
  - 910/21 125 mm
  - 910/22 250 mm
  - 910/25
  - 910/42
  - 910/55Q
- ≡ 335x145x60 mm - 2,3 kg

## 910A/C17

jogo com 17 chaves de caixa hexagonais e 9 acessórios

38"



910A/C17 € 358,00 1 009100938

- 910A 6 - 7 - 8 - 9 - 10 - 11 - 12 - 13  
14 - 15 - 16 - 17 - 18 - 19 - 20  
21 - 22 mm
  - 910/15 □ 3/8 - ■ 1/4
  - 910/16 □ 3/8 - ■ 1/2
  - 910/21 125 mm
  - 910/22 250 mm
  - 910/25
  - 910/36A
  - 910/42
  - 910/46
  - 910/55
- ≡ 420x280x60 mm - 4,0 kg

## 910.../C29

jogo com 17 chaves de caixa, 12 pontas e 5 acessórios

38"



910A/C29 € 410,00 1 009100944

- 910A 6 - 7 - 8 - 9 - 10 - 11 - 12 - 13  
14 - 15 - 16 - 17 - 18 - 19 - 20  
21 - 22 mm
  - 910LP 1x5,5 - 1,2x6,5 - 1,2x8 mm
  - ⊕ 910PH PH1 - PH2 - PH3
  - 910PE 3 - 4 - 5 - 6 - 8 - 10 mm
  - 910/21 125 mm
  - 910/22 250 mm
  - 910/25
  - 910/42
  - 910/55
- ≡ 420x185x60 mm - 3,5 kg

910B/C29 € 410,00 1 009100945

- 910B 6 - 7 - 8 - 9 - 10 - 11 - 12 - 13  
14 - 15 - 16 - 17 - 18 - 19 - 20  
21 - 22 mm
  - 910LP 1x5,5 - 1,2x6,5 - 1,2x8 mm
  - ⊕ 910PH PH1 - PH2 - PH3
  - 910PE 3 - 4 - 5 - 6 - 8 - 10 mm
  - 910/21 125 mm
  - 910/22 250 mm
  - 910/25
  - 910/42
  - 910/55
- ≡ 420x185x60 mm - 3,5 kg

## 910AS/C13...

jogo com 13 chaves de caixa de 12 faces e 5 acessórios

38"



910AS/C13 € 240,00 1 009100925

- 910AS 1/4 - 5/16 - 11/32 - 3/8 - 7/16  
1/2 - 9/16 - 19/32 - 5/8 - 11/16  
3/4 - 13/16 - 7/8
  - 910/21 125 mm
  - 910/22 250 mm
  - 910/42
  - 910/25
  - 910/55
- ≡ 335x145x60 mm - 2,3 kg

## 910AS/MBM-C18

jogo com 13 chaves de caixa de 12 faces e 5 acessórios

38"



910AS/MBM-C18 € 258,00 1 009100926

- 910AS 1/4 - 5/16 - 11/32 - 3/8 - 7/16  
1/2 - 9/16 - 19/32 - 5/8 - 11/16  
3/4 - 13/16 - 7/8
  - 910/21 125 mm
  - 910/22 250 mm
  - 910/25
  - 910/42
  - 910M/55
- ≡ 335x145x60 mm - 2,5 kg

## 910A/C16HR

Jogo de 16 chaves de caixa sextavadas e 5 acessórios em módulo soft e caixa metálica

• roquete com punho rotativo

38"



910A/C16HR € 267,00 1 009100935

- 910A 6 - 7 - 8 - 9 - 10 - 11 - 12 - 13  
14 - 15 - 16 - 17 - 18 - 19  
21 - 22 mm
  - 910/21 125 mm
  - 910/22 250 mm
  - 910/25
  - 910/42
  - 910/58
- ≡ 335x145x60 mm - 2,4 kg

 **Beta**

## 920A

chaves de caixa boca hexagonal



UNI/ISO 2725 DIN 3124

mm	Ø	L	Ø1	€	1	009200008
8	12,4	38	21,7	5,05	10	009200008
9	13,5	38	21,7	5,05	10	009200009
10	14,9	38	21,7	5,05	10	009200010
11	16,1	38	21,7	5,05	10	009200011
12	17,5	38	21,7	5,05	10	009200012
13	18,7	38	21,7	5,50	10	009200013
14	20,1	38	21,7	5,50	10	009200014
15	21,5	38	22,5	5,50	10	009200015
16	22,7	38	23,7	5,85	10	009200016
17	24,1	38	23,1	5,85	10	009200017
18	25,3	39	24,0	5,85	10	009200018
19	26,6	39	24,0	5,85	10	009200019
20	27,8	40	25,0	6,75	5	009200020
21	28,8	40	25,0	6,75	5	009200021
22	29,9	41	26,0	6,75	5	009200022
23	30,8	42	26,0	7,35	5	009200023
24	32,2	43	27,0	7,35	5	009200024
25	33,2	44	27,0	7,35	5	009200025
26	34,7	45	28,0	7,70	5	009200026
27	36,2	46	29,0	7,70	5	009200027
28	37,2	47	30,0	7,70	5	009200028
29	38,6	48	31,0	8,30	5	009200029
30	40,2	48	32,0	8,30	5	009200030
32	42,3	49	33,9	8,55	5	009200032



**920A/SB13** 87,50 1 009200040  
10-11-12-13-14-15-16  
17-18-19-20-21-22 mm



**920A/SB8** 70,50 1 009200042  
23-24-25-26-27-28-30-32 mm

## 920B

chaves de caixa, boca de 12 faces

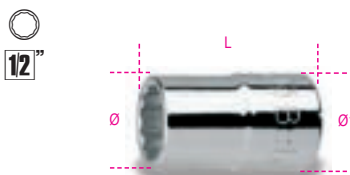

UNI/ISO 2725 DIN 3124

mm	Ø	L	Ø1	€	1	009200108
8	12,4	38	21,7	5,05	10	009200108
9	13,5	38	21,7	5,05	10	009200109
10	14,9	38	21,7	5,05	10	009200110
11	16,1	38	21,7	5,05	10	009200111
12	17,5	38	21,7	5,05	10	009200112
13	18,7	38	21,7	5,50	10	009200113
14	20,1	38	21,7	5,50	10	009200114
15	21,5	38	22,5	5,50	10	009200115
16	22,7	38	23,7	5,85	10	009200116
17	24,1	38	23,1	5,85	10	009200117

mm	Ø	L	Ø1	€	1	009200118
18	25,3	39	24,0	5,85	10	009200118
19	26,6	39	24,0	5,85	10	009200119
20	27,8	40	25,0	6,75	5	009200120
21	28,8	40	25,0	6,75	5	009200121
22	29,9	41	26,0	6,75	5	009200122
23	30,8	42	26,0	7,35	5	009200123
24	32,2	43	27,0	7,35	5	009200124
25	33,2	44	27,0	7,35	5	009200125
26	34,7	45	28,0	7,70	5	009200126
27	36,2	46	29,0	7,70	5	009200127
28	37,2	47	30,0	7,70	5	009200128
29	38,6	48	31,0	8,30	5	009200129
30	40,2	48	32,0	8,30	5	009200130
32	42,3	49	33,9	8,55	5	009200132



**920B/SB13** 87,50 1 009200140  
10-11-12-13-14-15-16  
17-18-19-20-21-22 mm



**920B/SB8** 70,50 1 009200142  
23-24-25-26-27  
28-30-32 mm

## 920AL

chaves de caixa série longa, boca hexagonal



UNI/ISO 2725 DIN 3124

mm	Ø	L	Ø1	€	1	009200626
10	14,7	77	21	16,20	5	009200626
12	17,8	77	21	16,20	5	009200627
13	19,0	77	22	16,20	5	009200628
14	20,3	77	22	16,20	5	009200629
15	21,5	77	22	16,20	5	009200630
16	22,8	77	22	16,90	5	009200631
17	24,0	77	23	16,90	5	009200632
18	25,0	77	24	18,30	5	009200633
19	26,5	77	25	18,30	5	009200634
21	29,0	77	27	20,20	5	009200635
22	30,0	77	28	20,20	5	009200636
23	31,5	77	29	20,20	5	009200637
24	32,8	77	30	22,90	5	009200638
27	36,5	77	33	24,00	3	009200639
30	40,0	77	36	29,00	3	009200640
32	42,8	77	38	29,50	3	009200641
36	48,0	77	41	48,00	3	009200642



**920AL/SB11** 205,00 1 009200644  
10-12-13-14-15-16  
17-18-19-21-22 mm



## 920BL

chaves de caixa série longa, boca de 12 faces

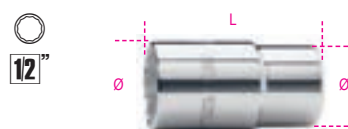

UNI/ISO 2725 DIN 3124

mm	Ø	L	Ø1	€	1	009200310
10	14,7	77	21	16,20	5	009200310
12	17,8	77	21	16,20	5	009200312
13	19,0	77	22	16,20	5	009200313
14	20,3	77	22	16,20	5	009200314
15	21,5	77	22	16,20	5	009200315
16	22,8	77	22	16,90	5	009200316
17	24,0	77	23	16,90	5	009200317
18	25,0	77	24	18,30	5	009200318
19	26,5	77	25	18,30	5	009200319
21	29,0	77	27	20,20	5	009200321
22	30,0	77	28	20,20	5	009200322
23	31,5	77	29	20,20	5	009200323
24	32,8	77	30	22,90	5	009200324
27	36,5	77	33	24,00	3	009200327
30	40,0	77	36	29,00	3	009200330
32	42,8	77	38	29,50	3	009200332
36	48,0	77	41	48,00	3	009200336



**920BL/SB11** 205,00 1 009200338  
10-12-13-14-15-16-17-18  
19-21-22 mm

## 920A/AS

chaves de caixa boca hexagonal

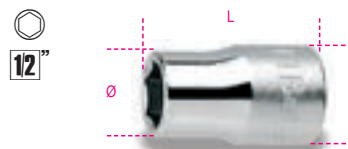

"	mm	L	Ø1	€	1	009200270
3/8	14,6	37	21	5,70	2	009200270
7/16	16,5	37	21	5,70	3	009200272
1/2	19,0	37	22	6,15	3	009200273
9/16	20,3	37	22	6,15	3	009200274
19/32	21,0	37	22	6,70	3	009200275
5/8	22,8	37	22	6,70	3	009200276
11/16	25,0	37	24	6,80	3	009200277
3/4	26,5	38	25	6,80	3	009200279
25/32	28,0	38	26	7,75	3	009200280
13/16	29,0	38	27	7,75	3	009200281
7/8	30,0	40	28	7,75	3	009200282
15/16	32,8	42	30	8,40	3	009200284
1	35,0	42	32	8,40	3	009200285
1.1/16	36,5	43	33	8,95	2	009200287
1.1/8	39,0	43	35	9,20	2	009200289
1.3/16	41,0	46	36	9,85	2	009200290
1.1/4	42,8	46	38	9,90	2	009200292



**920A-AS/SB11** 87,00 1 009200295  
3/8-7/16-1/2-9/16-5/8  
11/16-3/4-13/16-7/8  
15/16-1

## 920AS

chaves de caixa, boca de 12 faces

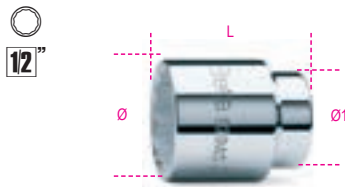

"	Ø mm	L mm	Ø1 mm	€		
3/8	14,9	38	21,7	5,70	3	009200201
7/16	16,1	38	21,7	5,70	3	009200202
1/2	18,7	38	21,7	6,15	3	009200203
9/16	20,1	38	21,7	6,15	3	009200204
5/8	22,7	38	22,5	6,70	3	009200206
19/32	21,5	38	23,7	6,70	3	009200207
11/16	25,3	39	24,0	6,80	3	009200208
3/4	26,6	39	24,0	6,80	3	009200209
25/32	27,8	40	25,0	7,75	3	009200210
13/16	28,8	40	25,0	7,75	3	009200211
7/8	29,9	41	26,0	7,75	3	009200212
15/16	32,2	43	27,0	8,40	3	009200214
1	34,2	45	28,0	8,40	3	009200216
1.1/16	36,2	46	29,0	8,95	2	009200217
1.1/8	38,6	48	31,0	9,20	2	009200218
1.3/16	40,2	48	32,0	9,85	2	009200219
1.1/4	42,3	49	33,5	9,90	2	009200220



920AS/SB11	€		
3/8-7/16-1/2-9/16-5/8 11/16-3/4-13/16-7/8 15/16-1	87,00	1	009200225

## 920AS/L

chaves de caixa série longa  
boca hexagonal



"	Ø mm	L mm	Ø1 mm	€		
1/2	19,0	77	22	22,10	2	009200352
9/16	20,3	77	22	22,10	2	009200353
5/8	22,8	77	22	22,10	2	009200355
11/16	25,0	77	24	23,50	2	009200357
3/4	26,5	77	25	24,00	2	009200358
13/16	29,0	77	27	28,00	2	009200360
7/8	30,0	77	28	28,00	2	009200361
15/16	32,8	77	30	29,00	2	009200362
1	35,0	77	32	30,00	2	009200363
1.1/16	36,5	77	33,0	33,00	2	009200364
1.1/8	37,8	77	34	34,00	2	009200365



920ASL/SB11	€		
1/2-9/16-5/8-11/16 3/4-13/16-7/8-15/16 1-1.1/8-1.1/16	308,00	1	009200369

## 920FTX

chaves de caixa para parafusos  
de perfil Torx®

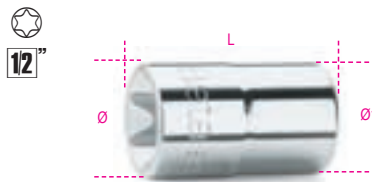

"	Ø mm	L mm	Ø1 mm	€		
E10	13,2	36	21	9,60	5	009200380
E12	15,0	37	21	9,60	5	009200381
E14	16,3	37	21	9,60	5	009200382
E16	18,8	37	22	9,60	5	009200383
E18	20,4	37	22	9,60	5	009200384
E20	22,9	37	22	10,40	5	009200385
E22	25,0	37	24	12,00	3	009200387
E24	26,5	40	25	13,70	3	009200388



920FTX/SB6	€		
E10-E12-E14 E16-E18-E20	66,50	1	009200390



920FTX/C8	€		
E10-E12-E14-E16 E18-E20-E22-E24	111,00	1	009200391

≡ 270X120X45 mm - 1 kg

## 920FTX/L

chaves de caixa série longa  
para parafusos de perfil Torx®



"	Ø mm	L mm	Ø1 mm	€		
E10	13,2	77	21,0	20,20	5	009200400
E12	15,0	77	21,0	20,20	5	009200401
E14	16,3	77	21,0	20,20	5	009200402
E16	18,8	77	21,8	20,20	3	009200403
E18	20,4	77	21,8	20,20	3	009200404
E20	22,9	77	22,0	20,20	3	009200405



920FTX-LSB6	€		
E10-E12-E14 E16-E18-E20	130,00	1	009200409

## 920LP

chaves de caixa com ponta  
de perfil de fenda



SxA mm	Ø mm	L mm	L1 mm	€		
1x5,5	22,5	62	24	15,90	3	009200452
1,2x6,5	22,5	62	24	15,90	3	009200453
1,2x8	22,5	62	24	15,90	3	009200454
1,6x9	22,5	62	24	15,90	3	009200456
2x12	22,5	62	24	15,90	3	009200458

## 920PH

chaves de caixa com ponta  
de perfil Phillips®



PH	Ø mm	L mm	L1 mm	€		
1	22,5	56	18	13,80	3	009200471
2	22,5	56	18	13,80	3	009200472
3	22,5	56	18	13,80	3	009200473
4	22,5	56	18	13,80	3	009200474

## 920LH/SB7

chaves de caixa com ponta  
de perfil Phillips®



920LH/SB7	€		
920LP 920PH	114,00	1	009200478

## 920PE

chaves de caixa com ponta macho hexagonal

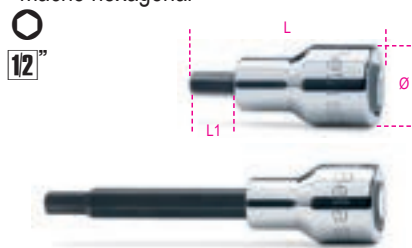

DIN 7422

mm	Ø mm	L mm	L1 mm	€	🔧	📦
3	22,5	58	20	12,60	5	009200410
4	22,5	58	20	12,60	5	009200412
5	22,5	58	20	12,60	5	009200414
5L	22,5	100	62	13,80	5	009200415
6	22,5	58	20	12,60	5	009200417
6L	22,5	100	62	13,80	5	009200418
7	22,5	58	20	12,60	5	009200420
7L	22,5	100	62	13,80	5	009200421
8	22,5	58	20	12,60	5	009200423
8L	22,5	100	62	13,80	5	009200424
9	22,5	58	20	12,60	5	009200425
9L	22,5	140	102	14,20	5	009200426
10	22,5	58	20	12,60	5	009200428
10L	22,5	140	102	14,20	5	009200429
12	23,0	58	20	14,80	5	009200432
12L	22,5	140	102	16,40	5	009200433
14	23,0	58	20	14,80	5	009200434
14L	22,5	140	102	16,40	5	009200435
17	29,5	60	22	18,00	5	009200437
19	29,5	60	22	18,00	5	009200439



**920PE/SB9** 129,00 € 1 009200441  
4-5-6-8-10 mm  
5L-6L-8L-10L mm



**920PE/C10** 167,00 € 1 009200443  
4-5-6-7-8-10  
12-14-17-19 mm  
270X120X45 mm - 1,5 kg

## 920PE/AS

chaves de caixa com ponta macho hexagonal



"	Ø mm	L mm	L1 mm	€	🔧	📦
1/8	22,5	58	20	14,70	2	009200460
3/16	22,5	58	20	14,70	2	009200461
1/4	22,5	58	20	14,70	2	009200463
3/8	22,5	58	20	14,70	2	009200464
1/2	22,5	60	20	15,90	2	009200465
3/4	22,5	60	20	16,90	1	009200468

## 920BP

chaves de caixa com ponta macho hexagonal esférico

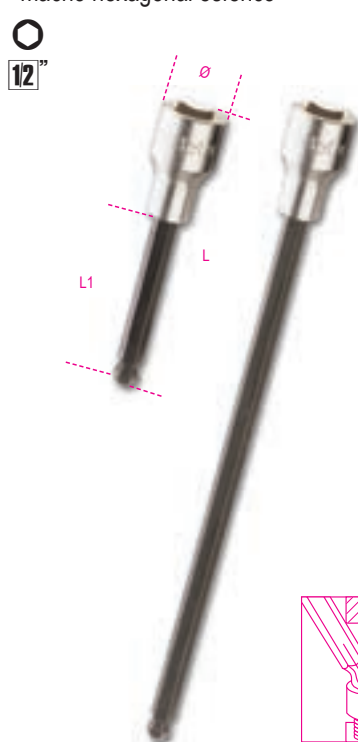

mm	Ø mm	L mm	L1 mm	€	🔧	📦
5L	22,5	100	62	15,90	5	009200490
5XL	22,5	240	202	20,20	1	009200495
6L	22,5	100	62	15,90	5	009200491
6XL	22,5	240	202	20,20	1	009200496
7L	22,5	100	62	15,90	5	009200492
8L	22,5	100	62	15,90	5	009200493
8XL	22,5	240	202	20,20	1	009200497
10L	22,5	140	102	16,90	5	009200494



**920BP/SB8** 151,00 € 1 009200500  
5L-6L-7L-8L-10L mm  
5XL-6XL-8XL mm

## 920ME

chaves de caixa com ponta macho hexagonal

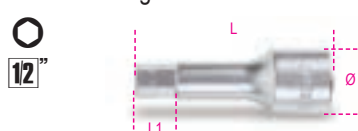

mm	Ø mm	L mm	L1 mm	€	🔧	📦
5	21	75	15,5	14,80	5	009200505
6	21	75	15,5	14,80	5	009200506
7	21	75	15,5	14,80	5	009200507
8	21	75	15,5	14,80	5	009200508
10	23	75	15,5	15,30	5	009200510
12	24	75	15,5	17,50	5	009200512
14	24	75	15,5	17,50	5	009200514
17	24	75	15,5	17,50	5	009200517



**920ME/SB7** 121,00 € 1 009200519  
5-6-8-10-12-14-17 mm



**920ME/C7** 137,00 € 1 009200518  
5-6-8-10-12-14-17 mm  
250X100X35 mm - 1,4 kg

## 920TX

chaves de caixa com ponta macho de perfil Torx®



mm	Ø mm	L mm	L1 mm	€	🔧	📦
T20	22,5	58	20	15,50	5	009200520
T20L	22,5	120	82	19,90	3	009200530
T25	22,5	58	20	15,50	5	009200521
T25L	22,5	120	82	19,90	3	009200531
T27	22,5	58	20	15,50	5	009200522
T27L	22,5	120	82	19,90	3	009200533
T30	22,5	58	20	15,50	5	009200523
T30L	22,5	120	82	19,90	3	009200534
T40	22,5	58	20	15,50	5	009200524
T40L	22,5	120	82	19,90	3	009200535
T45	22,5	58	20	15,50	5	009200525
T45L	22,5	120	82	19,90	3	009200537
T50	22,5	58	20	15,50	5	009200526
T50L	23,0	140	102	19,90	3	009200538
T55	23,0	58	20	20,80	3	009200527
T55L	23,0	140	102	28,00	3	009200539
T60	23,0	58	20	20,80	3	009200528
T60L	23,0	140	102	28,00	3	009200540
T70L	23,0	120	82	28,00	3	009200541



**920TX-SB9** 161,00 € 1 009200532  
T20-T25-T27-T30  
T40-T45-T50-T55-T60



**920TX-L/SB10** 235,00 € 1 009200545  
T20L-T25L-T27L-T30L-T40L-  
T45L-T50L-T55L-T60L-T70L



920TX/C9 € 177,00 1 009200546

T20-T25-T27-T30-T40  
T45-T50-T55-T60

270X120X45 mm - 1,2 kg

### 920RTX

chaves de caixa com ponta macho de perfil Tamper Resistant Torx®



	Ø mm	L mm	L1 mm	€		
T20	22,5	58	20	16,40	5	009200370
T25	22,5	58	20	16,40	5	009200371
T27	22,5	58	20	16,40	5	009200372
T30	22,5	58	20	16,40	5	009200373
T40	22,5	58	20	16,40	5	009200374



920RTX/SB5 € 89,00 1 009200378

T20-T25-T27-T30-T40

### 920XZN

chaves de caixa com ponta macho de perfil XZN(R)

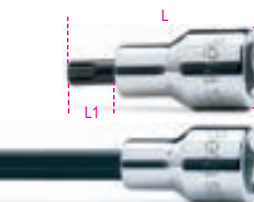

DIN 2324

	Ø mm	L mm	L1 mm	€		
M4	22,5	58	20	16,40	3	009200559
M5	22,5	58	20	16,40	3	009200560
M6	22,5	58	20	16,40	3	009200561
M6L	22,5	100	62	18,70	3	009200562
M8	22,5	58	20	16,40	3	009200563
M8L	22,5	100	62	18,70	3	009200564
M9	22,5	58	20	16,40	3	009200582
M9L	22,5	100	62	18,70	3	009200583
M10	22,5	58	20	16,40	3	009200565
M10L	22,5	100	62	18,70	3	009200566
M12	22,5	58	20	16,90	3	009200568
M12L	22,5	100	62	19,10	3	009200569
M14	23,0	58	20	16,90	3	009200571
M14L	23,0	100	62	19,10	3	009200572
M16	23,0	58	20	21,30	3	009200573
M18	23,0	58	20	21,80	3	009200574



920XZN/SB7 € 125,00 1 009200579

M4-M5-M6-M8  
M10-M12-M14



920XZN/SB12 € 229,00 1 009200577

M5-M6-M8-M10-M12  
M14-M16-M6L-M8L  
M10L-M12L-M14L



920XZN-L/S5 € 94,50 1 009200578

M6L-M8L-M10L  
M12L-M14L

### 920ES

chaves de caixa com pontas de 6 caneluras



UNI 9326

Ø mm		L mm	L1 mm	€		
7	(6R)	58	20	22,40	5	009200587
7XL	(6R)	240	202	32,50	1	009200607
9	(8R)	58	20	22,40	5	009200589
9XL	(8R)	240	202	32,50	1	009200609
10	(8S)	58	20	22,40	5	009200590
10XL	(8S)	240	202	32,50	1	009200610
11	(10R)	58	20	22,40	5	009200591
11XL	(10R)	240	202	32,50	1	009200611
12L	(10S)	100	62	25,00	3	009200592
12XL	(10S)	240	202	35,00	1	009200612
14L	(12S)	100	62	25,00	3	009200594
14XL	(12S)	240	202	35,00	1	009200614
16L	(14R)	100	62	25,00	3	009200596
16XL	(14R)	240	202	35,00	1	009200616



920ES/SB7 € 174,00 1 009200598

7-9-10-11-12L-14L-16L



920ES-XL/SB7 € 243,00 1 009200618

7XL-9XL-10XL-11XL  
12XL-14XL-16XL

### 920/15

redução quadra fêmea de 1/2" para quadra macho de 3/8"



UNI/ISO 3316 DIN 3123

L mm	□	■	Ø mm	€		
42	1/2	3/8	22,0	9,85	5	009200810



Aplique sempre uma força de aperto regular e progressiva, a fim de evitar a ruptura do material e de se proteger de um possível acidente

### 920/16

adaptador quadra fêmea de 1/2" para quadra macho de 3/4"



UNI/ISO 3316 DIN 3123

L mm	□	■	Ø mm	€		
46	1/2	3/4	26	12,60	5	009200814

### 920/20÷920/23

extensões com quadras macho e fêmea de 1/2"



UNI/ISO 3316 DIN 3123

	L mm	Ø mm	€		
920/20	75	22	12,00	5	009200818
920/21	125	22	14,80	5	009200822
920/22	255	22	16,40	5	009200826
920/23	375	22	21,80	2	009200827

### 920AN

extensões com quadras macho angulares e fêmea de 1/2"

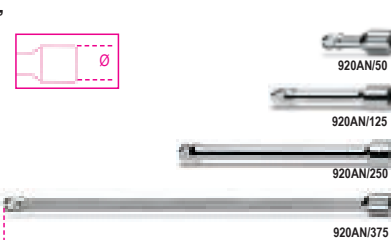

	L mm	Ø mm	€		
920AN/50	50	22	12,60	5	009200833
920AN/125	125	22	17,50	5	009200834
920AN/250	250	22	25,00	3	009200835
920AN/375	375	22	34,00	3	009200836



## 920/25

cardan com quadras macho e fêmea de 1/2"



UNI/ISO 3316 DIN 3123

L	Ø	€	🔧	📦
mm	mm			
75	27	23,30	5	009200830

## 920/35A

cabos articulados com punho quadra de 1/2"

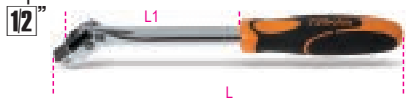

UNI/ISO 3315 DIN 3122

L	L1	€	🔧	📦
mm	mm			
285	160	46,50	3	009200846

## 920M/35

cabo articulado com punho metálico quadra de 1/2"



UNI/ISO 3315 DIN 3122

L	€	🔧	📦
mm			
380	66,50	2	009200845

## 920M/35L

punho articulado quadra macho 1/2" com cabo metálico, série longa



L	€	🔧	📦
mm			
600	101,50	1	009200843



Aplique sempre uma força de aperto regular e progressiva, a fim de evitar a ruptura do material e de se proteger de um possível acidente

## 920/36A

cabo articulado com punho quadra de 1/2"

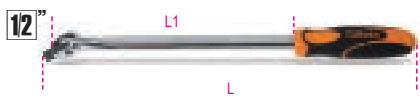

UNI/ISO 3315 DIN 3122

L	L1	€	🔧	📦
mm	mm			
408	283	52,00	2	009200847

## 920/38

cabo articulado extensível com punho, quadra 1/2"



L	L max	€	🔧	📦
mm	mm			
262	402	78,50	1	009200839

## 920/40

extensão articulada com punho em T quadra de 1/2"

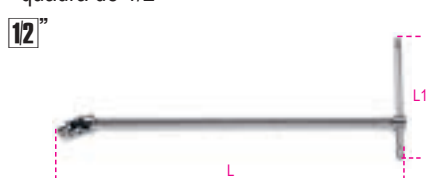

L	L1	€	🔧	📦
mm	mm			
490	230	53,50	2	009200850

## 920/42

cabo T corrediço, quadra de 1/2"

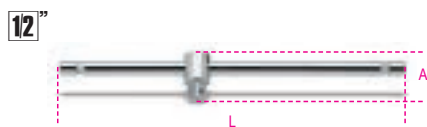

L	A	€	🔧	📦
mm	mm			
305	42	16,40	5	009200854

## 920/44

cabo angular quadra de 1/2"



L	L1	€	🔧	📦
mm	mm			
230	60	24,00	3	009200858

## 920/46

manivela quadra macho de 1/2"

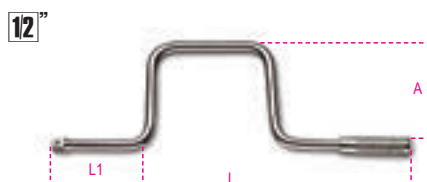

L	L1	A	€	🔧	📦
mm	mm	mm			
385	110	160	29,50	1	009200862

## 920/50

roquete simples quadra de 1/2" 72 dentes



UNI/ISO 3315 DIN 3122

L	Ø	A	€	🔧	📦
mm	mm	mm			
275	40	42	52,00	3	009200871

## 920/50F

roquete simples quadra fêmea de 1/2" 72 dentes



UNI/ISO 3315 DIN 3122

L	Ø	A	€	🔧	📦
mm	mm	mm			
275	40	27	48,00	2	009200889

## 920/55

roquete reversível com quadra de 1/2" 72 dentes



UNI/ISO 3315 DIN 3122

L	Ø	A	€	🔧	📦
mm	mm	mm			
275	40	43	55,50	3	009200882

## 920/55Q

roquete reversível com quadra de 1/2" 48 dentes



UNI/ISO 3315 DIN 3122

L	Ø	A	€	🔧	📦
mm	mm	mm			
275	40	43	55,50	3	009200885



## 920/55X

roquete reversível com quadra de 1/2"  
72 dentes



UNI/ISO 3315 DIN 3122

L	Ø	A	€	📦	📄
mm	mm	mm			
200	30	33	47,00	3	009200895

## 920/55LC

roquete reversível com quadra de 1/2"  
"Locking System" de 72 dentes



UNI/ISO 3315 DIN 3122

L	Ø	A	€	📦	📄
mm	mm	mm			
275	40	43	64,00	2	009200896

## 920/55L

roquete reversível extensível,  
quadra macho 1/2",  
72 dentes

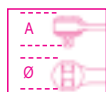

L	L max	Ø	A	€	📦	📄
mm	mm	mm	mm			
282	422	40	43	96,00	1	009200927

## 920M/55

roquete reversível com punho metálico  
quadra de 1/2"



L	Ø	A	€	📦	📄
mm	mm	mm			
253	38	35	72,00	1	009200893

## 920/56A

roquete reversível articulado  
quadra de 1/2" de 72 dentes



L	Ø	A	€	📦	📄
mm	mm	mm			
315	40	43	89,50	1	009200911

## 920M/56

roquete reversível articulado  
com punho metálico, quadra de 1/2"



L	Ø	A	€	📦	📄
mm	mm	mm			
330	38	35,7	95,00	2	009200894

## 920/58

roquete reversível quadra 1/2"  
com punho rotativo,  
52 dentes

- Funcionamento através de punho rotativo
- Botão de desbloqueio da chave de caixa
- Sistema de inversão através de porca na cabeça do roquete
- Punho bi-material



L	Ø	A	€	📦	📄
mm	mm	mm			
281	42,5	45	82,50	1	009200926

Ver quadro depois do artigo 929/C8  
para acessórios compatíveis usados

## 920.../C11

jogo com 11 chaves de caixa  
e 2 acessórios

12"



920A/C11	€	📦	📄
	177,00	1	009200921

	920A	10 - 12 - 13 - 14 - 15 - 16 17 - 18 - 19 - 21 - 22 mm
	920/22	255 mm
	920/50	
	335x145x60 mm - 2,5 kg	

920B/C11	€	📦	📄
	177,00	1	009200922

	920B	10 - 12 - 13 - 14 - 15 - 16 17 - 18 - 19 - 21 - 22 mm
	920/22	255 mm
	920/50	
	335x145x60 mm - 2,5 kg	

## 920.../C12...

jogo com 12 chaves de caixa  
e 5 acessórios

12"









920A/C12X	€	📦	📄
	256,00	1	009200933

	920A	10 - 11 - 12 - 13 - 14 - 17 - 19 22 - 24 - 27 - 30 - 32 mm
	920/21	125 mm
	920/22	255 mm
	920/25	
	920/42	
	920/55	
	420x185x60 mm - 4,2 kg	

920A/C12	€	📦	📄
	252,00	1	009200931







	920A	10 - 11 - 12 - 13 - 14 - 17 - 19 22 - 24 - 27 - 30 - 32 mm
	920/21	125 mm
	920/22	255 mm
	920/25	
	920/42	
	920/50	
	420x185x60 mm - 4,2 kg	

920B/C12X € 256,00 1 009200934

-  920B 10 - 11 - 12 - 13 - 14 - 17 - 19  
22 - 24 - 27 - 30 - 32 mm
-  920/21 125 mm
-  920/22 255 mm
-  920/25
-  920/42
-  920/55

420x185x60 mm - 4,0 kg

920B/C12 € 252,00 1 009200932

-  920B 10 - 11 - 12 - 13 - 14 - 17 - 19  
22 - 24 - 27 - 30 - 32 mm
-  920/21 125 mm
-  920/22 255 mm
-  920/25
-  920/42
-  920/50

420x185x60 mm - 4,0 kg







## 920.../C20...

jogo com 20 chaves de caixa e 5 acessórios

12"









920A/C20X € 321,00 1 009200950

-  920A 10 - 11 - 12 - 13 - 14 - 15 - 16  
17 - 18 - 19 - 20 - 21 - 22 - 23  
24 - 26 - 27 - 28 - 30 - 32 mm
-  920/21 125 mm
-  920/22 255 mm
-  920/25
-  920/42
-  920/55





420x185x60 mm - 5,1 kg

920A/C20 € 318,00 1 009200948

-  920A 10 - 11 - 12 - 13 - 14 - 15 - 16  
17 - 18 - 19 - 20 - 21 - 22 - 23  
24 - 26 - 27 - 28 - 30 - 32 mm
-  920/21 125 mm
-  920/22 255 mm
-  920/25
-  920/42
-  920/50







420x185x60 mm - 5,1 kg

920A/C20Q € 321,00 1 009200955

-  920A 10 - 11 - 12 - 13 - 14 - 15 - 16  
17 - 18 - 19 - 20 - 21 - 22 - 23  
24 - 26 - 27 - 28 - 30 - 32 mm
-  920/21 125 mm
-  920/22 255 mm
-  920/25
-  920/42
-  920/55Q







420x185x60 mm - 5,1 kg

920B/C20 € 318,00 1 009200949

-  920B 10 - 11 - 12 - 13 - 14 - 15 - 16  
17 - 18 - 19 - 20 - 21 - 22 - 23  
24 - 26 - 27 - 28 - 30 - 32 mm
-  920/21 125 mm
-  920/22 255 mm
-  920/25
-  920/42
-  920/50

420x185x60 mm - 5,0 kg

920B/C20X € 321,00 1 009200951

-  920B 10 - 11 - 12 - 13 - 14 - 15 - 16  
17 - 18 - 19 - 20 - 21 - 22 - 23  
24 - 26 - 27 - 28 - 30 - 32 mm
-  920/21 125 mm
-  920/22 255 mm
-  920/25
-  920/42
-  920/55

420x185x60 mm - 5,0 kg







## 920.../C21...

jogo com 21 chaves de caixa e 6 acessórios

12"









920A/C21 € 367,00 1 009200952

-  920A 10 - 11 - 12 - 13 - 14 - 15 - 16  
17 - 18 - 19 - 20 - 21 - 22 - 23  
24 - 25 - 26 - 27 - 28 - 30 - 32 mm
-  920/21 125 mm
-  920/22 255 mm
-  920/25
-  920/42
-  920/46
-  920/50



420x280x60 mm - 6,5 kg

920A/C21X € 370,00 1 009200983

-  920A 10 - 11 - 12 - 13 - 14 - 15 - 16  
17 - 18 - 19 - 20 - 21 - 22 - 23  
24 - 25 - 26 - 27 - 28 - 30 - 32 mm
-  920/21 125 mm
-  920/22 255 mm
-  920/25
-  920/42
-  920/46
-  920/55

420x280x60 mm - 6,4 kg

920B/C21 € 367,00 1 009200953

-  920B 10 - 11 - 12 - 13 - 14 - 15 - 16  
17 - 18 - 19 - 20 - 21 - 22 - 23  
24 - 25 - 26 - 27 - 28 - 30 - 32 mm
-  920/21 125 mm
-  920/22 255 mm
-  920/25
-  920/42
-  920/46
-  920/50

420x280x60 mm - 6,4 kg

920B/C21X € 370,00 1 009200984

-  920B 10 - 11 - 12 - 13 - 14 - 15 - 16  
17 - 18 - 19 - 20 - 21 - 22 - 23  
24 - 25 - 26 - 27 - 28 - 30 - 32 mm
-  920/21 125 mm
-  920/22 255 mm
-  920/25
-  920/42
-  920/46
-  920/55

420x280x60 mm - 6,4 kg









## 920B/C30Q

jogo com 30 chaves de caixa de 12 faces e 5 acessórios

12"



920B/C30Q € 512,00 1 009200986

-  920B 10 - 11 - 12 - 13 - 14 - 15 - 16 - 17 - 18 - 19 - 20 - 21 - 22 - 23 - 24 - 26 - 27 - 28 - 30 - 32 mm
  -  920BL 12 - 13 - 14 - 17 - 19 - 21 - 22 - 24 - 27 - 30 mm
  -  920/21 125 mm
  -  920/22 255 mm
  -  920/25
  -  920/42
  -  920/55Q
- 420x280x60 mm - 6,7 kg









## 920.../C33

jogo com 20 chaves de caixa, 13 pontas e 5 acessórios

12"



920A/C33 € 512,00 1 009200985

-  920A 10 - 11 - 12 - 13 - 14 - 15 - 16 - 17 - 18 - 19 - 20 - 21 - 22 - 23 - 24 - 26 - 27 - 28 - 30 - 32 mm
  -  920LP 1,2x8 - 1,6x9 - 2x12 mm
  -  920PH PH2 - PH3 - PH4
  -  920PE 4 - 5 - 6 - 8 - 10 - 12 - 14 mm
  -  920/21 125 mm
  -  920/22 255 mm
  -  920/25
  -  920/42
  -  920/55
- 420x280x60 mm - 6,7 kg

920B/C33 € 512,00 1 009200986

-  920B 10 - 11 - 12 - 13 - 14 - 15 - 16 - 17 - 18 - 19 - 20 - 21 - 22 - 23 - 24 - 26 - 27 - 28 - 30 - 32 mm
  -  920LP 1,2x8 - 1,6x9 - 2x12 mm
  -  920PH PH2 - PH3 - PH4
  -  920PE 4 - 5 - 6 - 8 - 10 - 12 - 14 mm
  -  920/21 125 mm
  -  920/22 255 mm
  -  920/25
  -  920/42
  -  920/55
- 420x280x60 mm - 6,7 kg

## 920/C37

jogo com 37 chaves de caixa de 12 faces e 2 acessórios

12"



920/C37 € 487,00 1 009200988

-  920B 10 - 11 - 12 - 13 - 14 - 15 - 16 - 17 - 18 - 19 - 20 - 21 - 22 - 23 - 24 - 26 - 27 - 28 - 30 - 32 mm
  -  920AS 3/8 - 7/16 - 1/2 - 9/16 - 19/32 - 5/8 - 11/16 - 3/4 - 25/32 - 13/16 - 7/8 - 15/16 - 1 - 1.1/16 - 1.1/8 - 1.3/16 - 1.1/4
  -  920/21 125 mm
  -  920/22 255 mm
  -  920/25
  -  920/42
  -  920/55
- 420x280x60 mm - 7,5 kg



## 920AS/C10

jogo com 10 chaves de caixa de 12 faces e 2 acessórios

12"



920AS/C10 € 182,00 1 009200919

-  920AS 3/8 - 7/16 - 1/2 - 9/16 - 5/8 - 11/16 - 3/4 - 13/16 - 7/8 - 15/16
  -  920/22 255 mm
  -  920/50
- 335x145x60 mm - 2,6 kg

## 920AS/C15

jogo com 15 chaves de caixa de 12 faces e 6 acessórios

12"



920AS/C15 € 338,00 1 009200947

-  920AS 3/8 - 7/16 - 1/2 - 9/16 - 5/8 - 11/16 - 3/4 - 13/16 - 7/8 - 15/16 - 1 - 1.1/16 - 1.1/8 - 1.3/16 - 1.1/4
  -  920/21 125 mm
  -  920/22 255 mm
  -  920/25
  -  920/42
  -  920/46
  -  920/50
- 420x280x60 mm - 5,9 kg

 Beta

## 920AS/C17X

jogo com 17 chaves de caixa de 12 faces e 5 acessórios

12"



920AS/C17X € 319,00 1 009200942

	○ 920AS	3/8 - 7/16 - 1/2 - 9/16 - 19/32 - 5/8 11/16 - 3/4 - 25/32 - 13/16 - 7/8 15/16 - 1 - 1.1/16 - 1.1/8 - 1.3/16 - 1.1/4
	920/21	125 mm
	920/22	255 mm
	920/25	
	920/42	
	920/55	

420x185x60 mm - 4,8 kg

## 920AS/MBM-C21

jogo com 16 chaves de caixa de 12 faces e 5 acessórios

12"



920AS/MBM-C21 € 324,00 1 009200944

	○ 920AS	3/8 - 7/16 - 1/2 - 9/16 19/32 - 5/8 - 11/16 - 3/4 25/32 - 13/16 - 7/8 - 15/16 1 - 1.1/16 - 1.3/16 - 1.1/4
	920M/55	
	920/21	125 mm
	920/22	255 mm
	920/25	
	920/42	

420x185x60 mm - 5,0 kg

## 920TX/C17

jogo com 6 pontas, 6 chaves de caixa, 5 chaves de caixa com ponta e 4 acessórios, para parafusos de perfil Torx®



12"



920TX/C17 € 288,00 1 009200989

	861TX	T8 - T10 - T15 - T20 - T25 - T27
	897	
	920TX	T27 - T30 - T40 - T45 - T50
	920FTX	E10 - E12 - E14 - E16 - E18 - E20
	920/20	75 mm
	920/22	255 mm
	920/55	

420x185x60 mm - 2,9 kg

## 920A/C17HR

17 chaves de caixa sextavadas e 5 acessórios em estojo metálico com tabuleiro rígido

• roquete com punho rotativo

12"



920A/C17HR € 320,00 1 009200939

	○ 920A	10-11-12-13-14-15-16-17-18-19-20- 21-22-24-27-30-32 mm
	920/21	125 mm
	920/22	255 mm
	920/25	
	920/42	
	920/58	

420x185x60 mm - 5,1 kg

## 928A

chaves de caixa com boca hexagonal



3/4"



UNI/ISO 2725  
DIN 3124

Ø mm	Ø mm	L mm	Ø1 mm	€	5	10
19	29,2	50	34	15,00	5	009280019
22	31,3	53	34	15,20	5	009280022
23	33,3	53	34	15,40	5	009280023
24	34,5	53	34	15,60	5	009280024
26	36,8	55	35	16,80	5	009280026
27	38,0	56	35	16,80	5	009280027
28	39,0	57	35	17,60	3	009280028
29	40,2	58	35	17,90	3	009280029
30	41,5	58	37	18,10	3	009280030
32	44,3	60	37	19,10	3	009280032
33	45,8	60	37	20,20	3	009280033
34	46,8	60	37	20,20	3	009280034
35	48,1	62	38	21,00	3	009280035
36	49,5	64	38	21,00	3	009280036
38	52,0	68	40	22,90	3	009280038
41	56,0	71	40	25,50	3	009280041
46	62,3	75	43	32,00	3	009280046
50	67,4	80	43	38,50	3	009280050
55	73,7	84	48	48,00	1	009280055
60	80,0	87	48	54,50	1	009280060

## 928B

chaves de caixa boca de 12 faces



3/4"



UNI/ISO 2725  
DIN 3124

Ø mm	Ø mm	L mm	Ø1 mm	€	5	10
19	29,2	50	34	15,00	5	009280119
22	31,3	53	34	15,20	5	009280122
23	33,3	53	34	15,40	5	009280123
24	34,5	53	34	15,60	5	009280124
26	36,8	55	35	16,80	5	009280126
27	38,0	56	35	16,80	5	009280127
28	39,0	57	35	17,60	3	009280128
29	40,2	58	35	17,90	3	009280129
30	41,5	58	37	18,10	3	009280130
32	44,3	60	37	19,10	3	009280132
33	45,8	60	37	20,20	3	009280133
34	46,8	60	37	20,20	3	009280134
35	48,1	62	38	21,00	3	009280135
36	49,5	64	38	21,00	3	009280136
38	52,0	68	40	22,90	3	009280138
41	56,0	71	40	25,50	3	009280141
46	62,3	75	43	32,00	3	009280146
50	67,4	80	43	38,50	3	009280150
55	73,7	84	48	48,00	1	009280155
60	80,0	87	48	54,50	1	009280160

## 928AS

chaves de caixa boca hexagonal

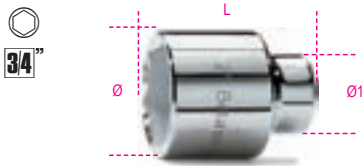

mm	Ø	L	Ø1	€	U	PC
mm	mm	mm	mm			
7/8	32,0	53	34	16,90	1	009280202
15/16	34,5	53	34	16,90	1	009280203
1	36,2	55	35	18,00	1	009280204
1.1/16	38,0	56	35	18,60	1	009280205
1.1/8	40,2	58	35	19,10	1	009280206
1.1/4	44,2	60	37	20,80	1	009280208
1.5/16	45,8	60	37	21,30	1	009280209
1.3/8	48,1	62	38	22,40	1	009280210
1.7/16	49,5	64	38	23,50	1	009280211
1.1/2	52,0	68	40	25,00	1	009280212
1.5/8	56,0	71	40	28,00	1	009280214
1.11/16	58,8	74	40	32,50	1	009280215
1.13/16	62,3	75	43	36,00	1	009280217
1.7/8	65,0	78	43	38,50	1	009280218
2	68,3	80	43	44,50	1	009280219
2.1/16	71,5	83	48	52,00	1	009280220

## 928ME

chave de caixa com ponta macho hexagonal

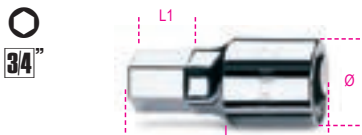

mm	Ø	L	L1	€	U	PC
mm	mm	mm	mm			
14	35	75	15,5	34,00	2	009280514
17	35	75	15,5	34,00	2	009280517
19	35	75	15,5	34,00	2	009280519
22	35	75	22,5	34,00	2	009280522

## 928/15

redução quadra fêmea de 3/4" para quadra macho de 1/2"



UNI/ISO 3316  
DIN 3123

L	Ø	mm	mm	mm	mm	€	U	PC
mm	mm	mm	mm	mm	mm			
51,5	34	3/4	1/2	17,50	5	009280801		



Aplique sempre uma força de aperto regular e progressiva, a fim de evitar a ruptura do material e de se proteger de um possível acidente

# Beta

## 928/16

adaptador quadra fêmea de 3/4" para quadra macho de 1"



UNI/ISO 3316  
DIN 3123

L	Ø	mm	mm	mm	mm	€	U	PC
mm	mm	mm	mm	mm	mm			
65	34	3/4	1"	21,30	5	009280807		

## 928/20 - 928/21 - 928/22

extensões com quadras macho e fêmea de 3/4"

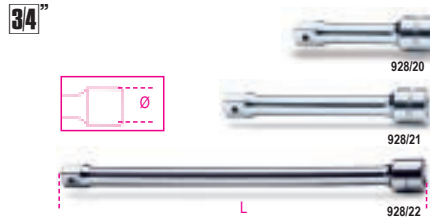

UNI/ISO 3316  
DIN 3123

	L	Ø	mm	mm	€	U	PC
	mm	mm	mm	mm			
928/20	100	34	20,80	3	009280810		
928/21	200	34	28,50	3	009280815		
928/22	380	34	42,00	3	009280825		

## 928/25

cardan com quadras macho e fêmea 3/4"



UNI/ISO 3316 DIN 3123

L	Ø	mm	mm	€	U	PC
mm	mm	mm	mm			
108	40	72,00	1	009280830		

## 928/36A

cabo articulado, quadra de 3/4" com punho



L	€	U	PC
mm			
545	86,50	1	009280844

## 928/42

cabo T corrediço, quadra de 3/4"

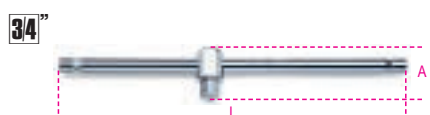

UNI/ISO 3315 DIN 3122

L	A	mm	mm	€	U	PC
mm	mm	mm	mm			
450	62,5	45,50	3	009280850		

## 928/55

roquete reversível com quadra de 3/4" 72 dentes



L	Ø	A	mm	mm	mm	€	U	PC
mm	mm	mm	mm	mm	mm			
510	58	59	145,00	2	009280862			

Ver quadro depois do artigo 929/C8 para acessórios compatíveis usados

## 928.../C12

jogo de 12 chaves de caixa hexagonal e 5 acessórios em caixa metálica



928A/C12	€	U	PC
	714,00	1	009280955

928A	22 - 24 - 27 - 30 - 32 - 34 - 36 38 - 41 - 46 - 50 - 55 mm
928/21	200 mm
928/22	380 mm
928/25	
928/42	
928/55	

530x220x80 mm - 13,5 kg

928B/C12	€	U	PC
	714,00	1	009280957

928B	22 - 24 - 27 - 30 - 32 - 34 - 36 38 - 41 - 46 - 50 - 55 mm
928/21	200 mm
928/22	380 mm
928/25	
928/42	
928/55	

530x220x80 mm - 13,5 kg

## 928AS/C12

jogo de 12 chaves de caixa hexagonal e 6 acessórios em caixa metálica



928AS/C12 € 742,00 1 009280968

	928AS	7/8-15/16-1.1/16-1.1/8-1.1/4 1.5/16-1.7/16-1.1/2-1.11/16 1.13/16-1.7/8-2.1/16
	928/21	200 mm
	928/22	380 mm
	928/25	
	928/42	
	928/55	

530x220x80 mm - 13,5 kg

## 929

chaves de caixa com boca hexagonal

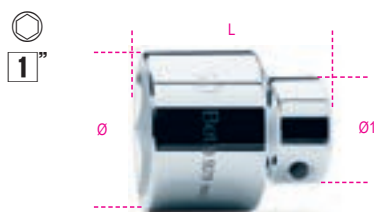

UNI/ISO 2725 DIN 3124

Ø	Ø	L	Ø1	€	1	009290036
mm	mm	mm	mm			
36	49,5	65	48	40,50	1	009290036
41	56,0	70	48	42,00	1	009290041
46	62,0	75	48	44,50	1	009290046
50	67,5	80	48	51,00	1	009290050
55	74,0	85	54	56,00	1	009290055
60	80,0	90	54	65,50	1	009290060
65	86,0	95	54	71,00	1	009290065
70	92,0	100	60	83,00	1	009290070
75	99,0	110	60	92,00	1	009290075
80	106,0	120	60	101,50	1	009290080

## 929/15

redução quadra fêmea de 1" para quadra macho de 3/4"

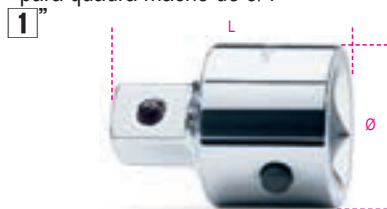

UNI/ISO 3316 DIN 3123

L	Ø	1"	3/4"	€	2	009290801
mm	mm					
65	47	1"	3/4"	37,00	2	009290801



Aplique sempre uma força de aperto regular e progressiva, a fim de evitar a ruptura do material e de se proteger de um possível acidente

## 929/21 - 929/22

extensões com quadras macho e fêmea de 1"



UNI/ISO 3316 DIN 3123

	L	Ø	€	1	009290815
	mm	mm			
929/21	200	47	49,00	1	009290815
929/22	400	47	69,00	1	009290825

## 929/42

cabo T correção, quadra de 1"



UNI/ISO 3315 DIN 3122

L	€	1	009290850
mm			
535	90,00	1	009290850

## 929/55

roquete reversível, quadra de 1" 72 dentes



UNI/ISO 3315 DIN 3122

L	Ø	A	€	1	009290860
mm	mm	mm			
770	62	63	191,00	1	009290860

## 929/C8

jogo com 8 chaves de caixa e 5 acessórios



929/C8 € 1.171,00 1 009290925

	929	46 - 50 - 55 - 60 - 65 70 - 75 - 80 mm
	929/15	□ 1" - ■ 3/4"
	929/21	200 mm
	929/22	400 mm
	929/42	
	929/55	

560x290x12 mm - 29 kg

## 900/R55



900/R55 € 32,00 1 009000871  
900/55

## 900M/R55



900M/R55 € 15,90 1 009000888  
900M/55

## 910/R55



910/R55 € 31,50 1 009100879  
606/6-606/10-612  
666/6-666/10-910/55  
599DGT/6

## 910M/R55



910M/R55 € 16,90 1 009100888  
910M/55-910M/56

## 910/R55Q



910/R55Q € 31,50 1 009100877  
910/55Q

## 910/R55X



910/R55X € 32,00 1 009100897  
666N/2X

## 920/R50



920/R50  
614/50-667/20-667/30  
920/50

€ 31,00 1 009200866

## 920/R55



920/R55  
606/20-606/30-666/20-666/30  
920/55-920/56A- 599DGT/20-599DGT/30

€ 37,00 1 009200879

## 920M/R55



920M/R55  
920M/55-920M/56

€ 18,60 1 009200888

## 920/R55Q



920/R55Q  
920/55Q

€ 37,00 1 009200877

## 920/R55X



920/R55X  
606/10X-612X  
666/10X-920/55X-599DGT/10X

€ 31,00 1 009200878

## 920/R55LC



920/R55LC  
920/55LC "Locking System"

€ 39,00 1 009200887

## 928/R55



928/R55  
928/55

€ 60,50 1 009280859

## 928/R55X



928/R55X  
614X

€ 38,50 1 009280858

## 929/R55



929/R55  
929/55

€ 71,00 1 009290859

## 930

chaves tubulares de 12 faces,  
serviço pesado



UNI 6745

mm	L	Ø	Ø1	€	1	009300006
6x7	100	9,5	11,0	12,00	3	009300006
8x9	108	12,5	14,0	14,90	3	009300010
10x11	116	15,0	16,5	15,50	3	009300014
12x13	124	17,5	19,0	18,50	3	009300018
14x15	132	20,0	21,5	20,20	3	009300023
16x17	140	23,0	24,0	23,30	3	009300027
18x19	148	25,0	26,5	25,50	3	009300032
20x22	156	28,0	30,0	28,50	2	009300036
21x23	163	29,0	31,5	31,00	2	009300040
24x26	173	33,0	35,5	39,00	2	009300044
25x28	182	34,5	38,0	42,00	2	009300048
27x29	191	37,0	39,5	48,00	2	009300052
30x32	200	40,5	43,0	57,50	2	009300056



930/S8  
6x7-8x9-10x11  
12x13-14x15-16x17  
18x19-20x22 mm  
940/1 - /2

€ 170,00 1 009300081

930/S13  
6x7-8x9-10x11-12x13  
14x15-16x17-18x19  
20x22-21x23-24x26  
25x28-27x29-30x32 mm  
940/1 - /2 - /3

€ 398,00 1 009300083



930/C13  
6x7-8x9-10x11-12x13  
14x15-16x17-18x19  
20x22-21x23-24x26  
25x28-27x29-30x32 mm  
940/1 - /2 - /3

€ 438,00 1 009300098

## 932

chaves de cachimbo 6 faces/12 faces  
em cromado brilhante

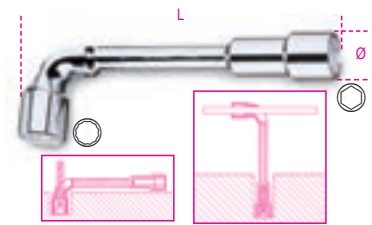

NF E 74.303

mm	Ø	L	€	1	009320006
6x6	11,5	110	13,50	5	009320006
7x7	12,5	116	13,70	5	009320007
8x8	13,0	120	14,20	5	009320008
9x9	14,0	125	14,80	5	009320009
10x10	16,5	133	15,30	5	009320010
11x11	17,5	143	16,60	5	009320011
12x12	19,0	148	17,70	5	009320012
13x13	19,5	154	18,40	5	009320013
14x14	21,5	167	19,30	5	009320014
15x15	22,5	182	20,40	5	009320015
16x16	24,5	193	21,30	5	009320016
17x17	26,0	198	21,50	5	009320017
18x18	26,5	215	23,50	5	009320018
19x19	29,0	220	26,00	5	009320019
20x20	30,5	222	27,50	3	009320020
21x21	30,5	236	32,00	3	009320021
22x22	32,5	250	35,00	2	009320022
23x23	33,5	256	38,50	2	009320023
24x24	35,0	272	40,50	2	009320024
25x25	36,5	282	44,00	2	009320025
26x26	37,5	296	48,00	2	009320026
27x27	39,0	296	51,00	2	009320027
28x28	39,0	314	57,00	2	009320028
30x30	42,5	348	67,50	2	009320030
32x32	45,5	364	75,50	2	009320032



932/S11  
6-7-8-10-11-12  
13-14-17-19-22 mm

€ 211,00 1 009320080

932/S17  
6-7-8-9-10-11-12  
13-14-15-16-17  
18-19-20-21-22 mm

€ 349,00 1 009320081

932/S25  
6-7-8-9-10-11-12-13  
14-15-16-17-18-19  
20-21-22-23-24-25  
26-27-28-30-32 mm

€ 769,00 1 009320082

## 933

chaves de cachimbo hexagonal em cromado brilhante

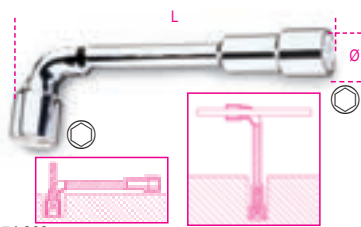

NF E 74.303

Ø mm	Ø mm	L mm	€	🔧	📦
6x6	11,5	110	13,50	5	009330006
7x7	12,5	116	13,70	5	009330007
8x8	13,0	120	14,20	5	009330008
9x9	14,0	125	14,80	5	009330009
10x10	16,5	133	15,30	5	009330010
11x11	17,5	143	16,60	5	009330011
12x12	19,0	148	17,70	5	009330012
13x13	19,5	154	18,40	5	009330013
14x14	21,5	167	19,30	5	009330014
15x15	22,5	182	20,40	5	009330015
16x16	24,5	193	21,30	5	009330016
17x17	26,0	198	21,50	5	009330017
18x18	26,5	215	23,50	5	009330018
19x19	29,0	220	26,00	5	009330019
20x20	30,5	222	27,50	3	009330020
21x21	30,5	236	32,00	3	009330021
22x22	32,5	250	35,00	2	009330022
23x23	33,5	256	38,50	2	009330023
24x24	35,0	272	40,50	2	009330024
25x25	36,5	282	44,00	2	009330025
26x26	37,5	296	48,00	2	009330026
27x27	39,0	296	51,00	2	009330027
28x28	39,0	314	57,00	2	009330028
30x30	42,5	348	67,50	2	009330030
32x32	45,5	364	75,50	2	009330032



933/S11	€	🔧	📦
6-7-8-10-11-12 13-14-17-19-22 mm	211,00	1	009330080
933/S17	349,00	1	009330081
6-7-8-9-10-11-12 13-14-15-16-17 18-19-20-21-22 mm	769,00	1	009330082
933/S25	769,00	1	009330082
6-7-8-9-10-11-12-13 14-15-16-17-18-19 20-21-22-23-24-25 26-27-28-30-32 mm			

## 935

chaves tubulares hexagonais, série ligeira



UNI 6746 DIN 896

Ø mm	L mm	€	🔧	📦
6x7	100	7,00	5	009350105
8x9	110	7,55	5	009350111
10x11	120	8,20	5	009350115
12x13	130	9,30	5	009350117
14x15	140	10,90	5	009350126
16x17	150	11,80	5	009350128
18x19	160	14,20	5	009350131
20x22	170	17,20	3	009350138
21x23	180	19,10	3	009350141
24x26	190	21,80	3	009350144
25x28	200	23,50	2	009350150
27x29	210	28,00	2	009350153
30x32	220	30,00	2	009350156

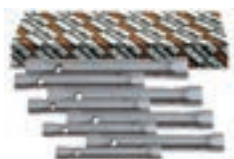

935/S8	€	🔧	📦
6x7-8x9-10x11 12x13-14x15-16x17 18x19-20x22 mm	98,00	1	009350181
940/1 - /2			
935/S13	€	🔧	📦
6x7-8x9-10x11 12x13-14x15-16x17 18x19-20x22-21x23 24x26-25x28-27x29 30x32 mm	232,00	1	009350183
940/1 - /2 - /3			

## 937

chaves de cachimbo 6 faces/12 faces cromadas

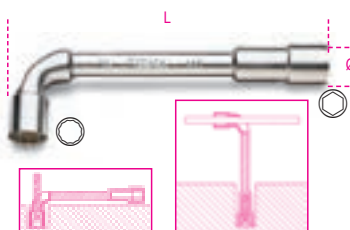

Ø mm	Ø mm	L mm	€	🔧	📦
6x6	11,5	110	7,35	5	009370006
7x7	12,5	116	7,65	5	009370007
8x8	13,0	120	8,00	5	009370008
9x9	14,0	125	8,40	5	009370009
10x10	16,5	133	8,75	5	009370010
11x11	17,5	143	9,30	5	009370011
12x12	19,0	148	10,10	5	009370012
13x13	19,5	154	10,60	5	009370013
14x14	21,5	167	11,50	5	009370014
15x15	22,5	182	12,90	5	009370015
16x16	24,5	193	13,80	5	009370016
17x17	26,0	198	14,40	5	009370017
18x18	26,5	215	14,80	5	009370018
19x19	29,0	220	15,30	5	009370019
20x20	30,5	222	17,40	3	009370020
21x21	30,5	236	19,10	3	009370021
22x22	32,5	250	20,20	2	009370022
23x23	33,5	256	22,40	2	009370023
24x24	35,0	272	23,50	2	009370024
25x25	36,5	282	29,50	2	009370025
26x26	37,5	296	31,00	2	009370026
27x27	39,0	296	31,50	2	009370027
28x28	39,0	314	37,50	2	009370028
30x30	42,5	348	40,50	2	009370030
32x32	45,5	364	45,00	2	009370032



937/S11	€	🔧	📦
6-7-8-10-11-12 13-14-17-19-22 mm	123,00	1	009370080
937/S17	€	🔧	📦
6-7-8-9-10-11-12 13-14-15-16-17 18-19-20-21-22 mm	209,00	1	009370081

## 940

passadores para chaves tubulares ref. 930 e 935



940/1	Ø mm	L mm	€	🔧	📦
	6÷13	100	4,95	5	009400001
940/2	14÷22	170	6,55	5	009400002
940/3	21÷32	290	12,00	5	009400003

## 941

chave de caixa sextavada/bisextavada, com punho de binário elevado

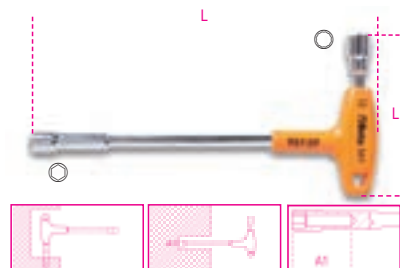

Ø mm	L mm	L1 mm	A1 mm	€	🔧	📦
7x7	200	91	35	24,40	2	009410107
8x8	220	107	50	26,00	2	009410108
9x9	220	109	50	26,50	2	009410109
10x10	236	111	50	27,50	2	009410110
11x11	236	114	50	28,50	2	009410111
12x12	255	122	50	31,50	2	009410112
13x13	255	124	55	32,00	2	009410113



941/S7	€	🔧	📦
7-8-9-10-11-12-13 mm	196,00	1	009410170

## 942BX

chave de caixa com punho sextavada de binário elevado modelo curto



UNI 6750

Ø mm	L mm	L1 mm	A1 mm	€	🔧	📦
4	190	70	13,0	12,40	5	009420003
5	190	70	14,0	12,40	5	009420004
5,5	190	70	12,5	14,10	5	009420005
6	190	70	14,5	14,10	5	009420006
7	190	70	15,5	14,70	5	009420007
8	202	70	18,5	14,70	5	009420008
9	202	70	19,5	14,70	5	009420009
10	202	70	20,5	15,70	3	009420010
11	202	70	21,5	15,70	3	009420011
12	202	70	22,5	15,70	3	009420012
13	202	70	23,5	17,50	3	009420013
14	202	70	24,5	17,50	3	009420014





**942BX/S12** € 179,00 1 009420030  
4-5-5,5-6-7-8-9  
10-11-12-13-14 mm

### 943BX

chave de caixa com punho sextavada de binário elevado modelo longo



ISO 2236 UNI 6750

Ø mm	L mm	L1 mm	A1 mm	€	U	U
4	270	150	13,0	13,80	5	009430003
5	270	150	14,0	13,80	5	009430004
5,5	270	150	12,5	14,90	5	009430005
6	270	150	14,5	14,90	5	009430006
7	270	150	15,5	16,00	5	009430007
8	282	150	18,5	16,00	5	009430008
9	282	150	19,5	16,00	5	009430009
10	282	150	20,5	17,20	3	009430010
11	282	150	21,5	17,20	3	009430011
12	282	150	22,5	17,20	3	009430012
13	282	150	23,5	18,30	3	009430013
14	282	150	24,5	18,30	3	009430014



**943BX/S12** € 193,00 1 009430030  
4-5-5,5-6-7-8-9  
10-11-12-13-14 mm



**943BX/D6** € 96,00 1 009430026  
5-6-7-8-10-13 mm



### 943FL

chaves de caixa hexagonal flexível com punho



Ø mm	L mm	L1 mm	Ø mm	€	U	U
5	265	150	8	19,20	2	009430304
5,5	265	150	8	19,20	2	009430305
6	265	150	9	19,20	2	009430306
7	265	150	11	19,20	2	009430307
8	265	150	12	20,00	2	009430308
10	290	175	14	21,10	2	009430310



**943FL/S6** € 118,00 1 009430320  
5-5,5-6-7-8-10 mm

### 944BX

chave de caixa com punho sextavada profunda de binário elevado modelo longo



ISO 2236 UNI 6750

Ø mm	L mm	L1 mm	A1 mm	€	U	U
4	245	125	20	14,40	3	009440003
5	245	125	25	14,40	3	009440004
5,5	245	125	30	17,80	3	009440005
6	245	125	35	17,80	3	009440006
7	245	125	35	17,80	3	009440007
8	257	125	50	18,90	3	009440008
9	257	125	50	18,90	3	009440009
10	257	125	50	19,70	3	009440010
11	257	125	50	19,70	3	009440011
12	257	125	50	21,30	3	009440012
13	257	125	55	21,30	3	009440013
14	257	125	55	21,30	3	009440014



**944BX/S12** € 223,00 1 009440062  
4-5-5,5-6-7-8-9  
10-11-12-13-14 mm



**944BX/D6** € 110,00 1 009440056  
5-6-7-8-10-13 mm

### 949

chaves de caixa com punho em T

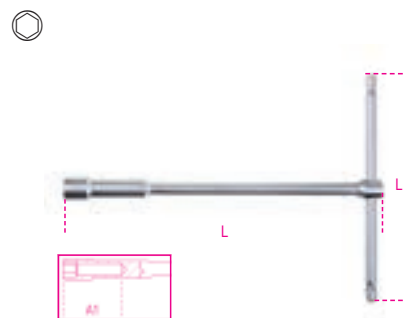

Ø mm	L mm	L1 mm	A1 mm	€	U	U
8	220	160	50	25,50	2	009490008
10	230	160	50	27,00	2	009490010
12	240	175	50	28,00	2	009490012
13	244	175	55	29,00	2	009490013
14	250	190	55	31,50	2	009490014
17	264	200	60	35,50	2	009490017



**949/S6** € 176,00 1 009490076  
8-10-12-13-14-17mm



## 950

chaves de caixa simples hexagonal com punho em T

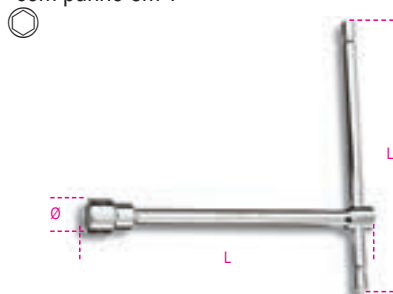

UNI 6742 DIN 3112

mm	L	Ø	L1	€	🔧	📦
6	210	10,1	145	18,00	3	009500006
7	212	11,2	145	18,00	3	009500007
8	220	12,4	160	19,20	3	009500008
9	223	13,5	160	19,20	3	009500009
10	230	14,9	160	21,00	3	009500010
11	233	16,1	160	21,00	3	009500011
12	240	17,5	175	23,20	3	009500012
13	244	19,7	175	23,30	3	009500013
14	250	20,1	190	26,00	3	009500014
15	254	21,5	190	27,00	3	009500015
16	260	22,7	200	30,00	3	009500016
17	264	24,1	200	31,50	3	009500017
19	274	26,6	230	38,50	3	009500019
22	290	29,9	290	46,50	2	009500022
24	300	32,2	320	53,00	2	009500024
27	315	36,2	370	63,00	2	009500027



<b>950/S9</b>	221,00	1	009500079
7-8-10-11-12 13-14-17-19 mm			
<b>950/S14</b>	361,00	1	009500082
6-7-8-9-10-11-12-13 14-15-16-17-19-22 mm			

## 951

chaves em T com macho hexagonal articulado

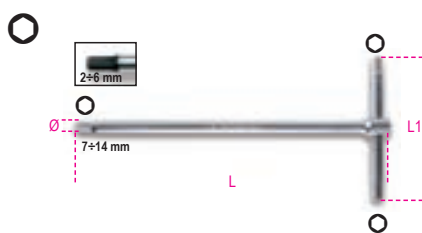

mm	L	L1	Ø	€	🔧	📦
2	125	63	4,0	16,40	5	009510521
2,5	150	63	4,0	16,40	5	009510525
3	150	63	4,0	16,40	5	009510530
3,5	175	76	5,5	16,90	5	009510535
4	175	76	5,5	16,90	5	009510540
4,5	195	87	6,5	18,60	5	009510545
5	195	87	6,5	18,60	5	009510550
6	215	99	8,0	21,50	5	009510560
7	230	109	9,0	23,20	5	009510570
8	250	122	10,0	23,20	5	009510580
9	265	132	11,0	29,00	5	009510590
10	280	142	12,0	29,00	5	009510610
12	305	160	15,0	39,50	3	009510620
14	330	178	17,0	49,00	3	009510640

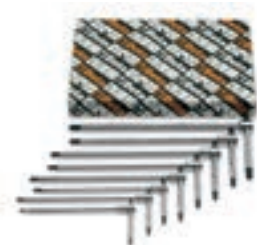

<b>951/S6</b>	113,00	1	009510687
2,5-3-4-5-6-8 mm			
<b>951/S8</b>	142,00	1	009510693
2-2,5-3-3,5-4-4,5-5-6 mm			
<b>951/S14</b>	334,00	1	009510695
2-2,5-3-3,5-4-4,5 5-6-7-8-9-10-12-14 mm			



<b>951/SP6</b>	145,00	1	009510696
3-4-5-6-8-10 mm			
<b>951/SPV</b>	25,00	1	009510697

## 951AS

chaves em T com macho hexagonal articulado

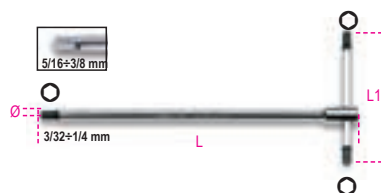

"	L	L1	Ø	€	🔧	📦
3/32	125	63	4,0	21,50	2	009510750
7/64	150	63	4,0	21,50	2	009510751
1/8	150	63	4,0	21,50	2	009510752
9/64	175	76	5,5	22,60	2	009510753
5/32	175	76	5,5	22,60	2	009510754
3/16	195	86	6,5	24,90	2	009510755
7/32	215	99	8,0	24,90	2	009510757
1/4	230	109	9,0	28,00	2	009510758
5/16	250	122	10,0	29,00	2	009510759
3/8	280	142	12,0	35,50	2	009510760

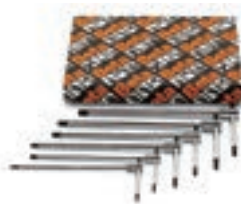

<b>951AS/S6X</b>	164,00	1	009510771
1/8-3/16-7/32-1/4-5/16-3/8			

## 951TX

chaves em T com pontas para parafusos de perfil Torx®, articulado



mm	L	L1	Ø	€	🔧	📦
<b>T6</b>	125	63	4	20,10	3	009510806
<b>T7</b>	125	63	4	20,10	3	009510807
<b>T8</b>	125	63	4	20,70	3	009510808
<b>T9</b>	125	63	4	20,70	3	009510809
<b>T10</b>	150	63	4	21,30	3	009510810
<b>T15</b>	150	63	4	21,30	3	009510815
<b>T20</b>	175	76	5	22,40	3	009510820
<b>T25</b>	175	76	5	22,40	3	009510825
<b>T27</b>	195	87	6	24,20	3	009510827
<b>T30</b>	195	87	6	24,20	3	009510830
<b>T40</b>	215	99	7	27,50	3	009510840
<b>T45</b>	230	109	8	29,50	3	009510845
<b>T50</b>	250	122	9	32,00	3	009510850

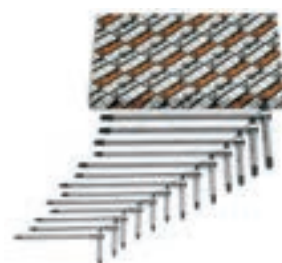

<b>951TX/S6</b>	132,00	1	009510866
T8-T10-T15-T20-T25-T30			
<b>951TX/S13</b>	306,00	1	009510863
T6-T7-T8-T9-T10-T15-T20-T25 T27-T30-T40-T45-T50			

## 952

chaves de caixa hexagonais com cardam e cabo em T

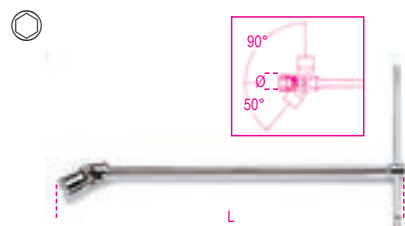

UNI 6743

mm	Ø	L	€	🔧	📦
<b>6</b>	9,5	395	27,50	5	009520006
<b>7</b>	10,7	395	27,50	5	009520007
<b>8</b>	12,1	395	27,50	5	009520008
<b>9</b>	13,2	395	27,50	5	009520009
<b>10</b>	14,6	400	30,00	5	009520010
<b>11</b>	15,8	400	30,00	5	009520011
<b>12</b>	17,0	400	30,00	5	009520012
<b>13</b>	18,7	432	32,50	5	009520013
<b>14</b>	19,7	432	32,50	5	009520014
<b>15</b>	20,9	450	40,00	3	009520015
<b>16</b>	22,0	450	40,00	3	009520016
<b>17</b>	23,4	450	40,00	3	009520017
<b>18</b>	24,7	450	40,00	3	009520018
<b>19</b>	26,0	500	49,00	3	009520019
<b>20</b>	27,4	500	49,00	3	009520020
<b>21</b>	28,5	500	49,00	3	009520021
<b>22</b>	29,7	500	49,00	3	009520022
<b>24</b>	32,4	500	49,00	3	009520024



	€		
<b>952/S7</b> 8-10-11-13-14-17-19 mm	240,00	1	009520074
<b>952/S10</b> 7-8-10-11-12-13-14-15-17-19 mm	337,00	1	009520080
<b>952/S18</b> 6-7-8-9-10-11-12-13-14-15-16-17-18-19-20-21-22-24 mm	666,00	1	009520083

## 952AS

chaves de caixa hexagonais com cardan e cabo em T

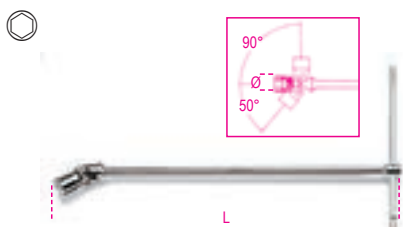

"	Ø mm	L mm	€		
1/4	9,5	395	31,00	2	009520256
5/16	12,1	395	31,00	2	009520258
3/8	14,6	400	33,00	2	009520260
7/16	15,8	400	33,00	2	009520261
1/2	18,7	432	37,00	2	009520263
9/16	19,7	432	40,00	2	009520264
5/8	22,0	450	43,00	2	009520266
11/16	23,4	450	43,00	2	009520267
3/4	26,0	500	53,00	2	009520269

## 952L

chaves de caixa hexagonais com cardan e cabo em T série longa

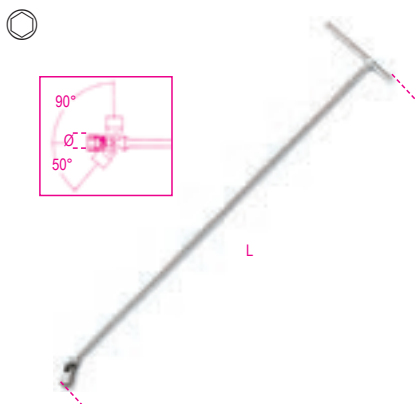

mm	Ø mm	L mm	€		
10	14,6	930	76,00	1	009520410
12	17,0	1063	76,00	1	009520412
13	18,7	1100	76,00	1	009520413
14	19,7	1100	76,00	1	009520414
15	20,9	1100	84,50	1	009520415
16	22,0	1100	84,50	1	009520416
17	23,4	1100	84,50	1	009520417
18	24,7	1100	84,50	1	009520418
19	26,0	1100	98,00	1	009520419

## 952FTX

chaves de caixa com cardan e cabo em T, para parafusos com perfil Torx®

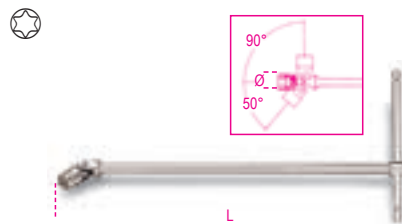

	Ø mm	L mm	€		
<b>E6</b>	8	392	33,00	2	009520106
<b>E7</b>	9	392	33,00	2	009520107
<b>E8</b>	10	395	37,50	2	009520108
<b>E10</b>	13	400	38,50	2	009520110
<b>E12</b>	15	440	46,50	2	009520112
<b>E14</b>	17	490	57,00	2	009520114
<b>E16</b>	19	490	57,00	2	009520116
<b>E18</b>	21	490	57,00	2	009520118
<b>E20</b>	23	490	57,00	2	009520120



	€		
<b>952FTX/S9</b> E6-E7-E8-E10-E12 E14-E16-E18-E20	414,00	1	009520141

## 953

chaves em T com macho hexagonal articulado

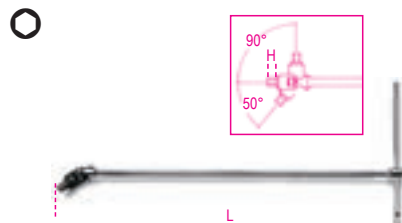

UNI 6754

mm	H mm	L mm	€		
3	5	395	28,50	5	009530130
3,5	6	395	28,50	3	009530135
4	6	395	28,50	5	009530140
4,5	7	395	28,50	3	009530145
5	7	395	28,50	5	009530150
6	9	400	31,00	5	009530160
7	10	425	34,00	3	009530170
8	11	425	34,00	5	009530180
10	13	440	41,00	5	009530200



	€		
<b>953/S5</b> 3-4-5-6-8 mm	150,00	1	009530305
<b>953/S9</b> 3-3,5-4-4,5 5-6-7-8-10 mm	281,00	1	009530301

## 953TX

chaves em T com macho de perfil Torx® articulado

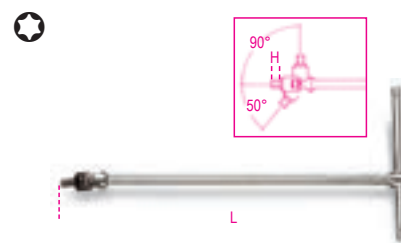

	H mm	L mm	€		
<b>T20</b>	11	396	35,00	2	009530020
<b>T25</b>	11	396	35,00	2	009530025
<b>T27</b>	11	396	35,00	2	009530027
<b>T30</b>	13	400	38,50	2	009530030
<b>T40</b>	13	400	38,50	2	009530040
<b>T45</b>	13	426	40,00	2	009530045
<b>T50</b>	14	442	47,00	2	009530050
<b>T55</b>	14	442	47,50	2	009530055



	€		
<b>953TX/S8</b> T20-T25-T27-T30 T40-T45-T50-T55	316,00	1	009530060

## 955

chave tubular para velas

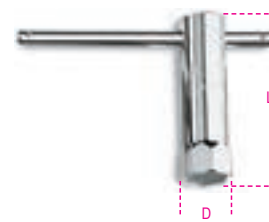

mm - "	D mm	L mm	€		
16	21	86	13,90	3	009550016
5/8					
20,8	29	86	13,90	3	009550021
13/16					

## 956C

chaves de caixa para velas quadra fêmea de 1/2"



ISO 11168

mm - "	Ø mm	L mm	€		
14	18,8	70	25,50	3	009560008
9/16					
16	21,4	70	25,50	3	009560010
5/8					
17,8	23,6	70	25,50	3	009560011
11/16					
20,8	27,0	70	25,50	3	009560012
13/16					

## 956E

chaves de caixa para velas quadra fêmea de 3/8"



ISO 11168

mm -"	Ø mm	L mm	€	🔧	📦
14	18,8	70	28,00	3	009560018
9/16					
16	21,4	70	28,00	3	009560020
5/8					
17,8	23,6	70	28,00	3	009560021
11/16					
20,8	27,0	70	28,00	3	009560022
13/16					

## 956F

chaves de caixa para velas quadra 3/8"



mm -"	Ø mm	L mm	€	🔧	📦
14	18,8	70	32,00	1	009560114
9/16					
16	20,5	70	39,50	1	009560116
5/8					

## 956L

chaves de caixa para velas quadra de 1/2", extremidades hexagonal, série longa



mm -"	Ø mm	L mm	€	🔧	📦
14	20,2	250	52,50	2	009560214
9/16					
16	24,0	250	54,50	2	009560216
5/8					
17,8	24,0	250	58,00	2	009560217
11/16					
20,8	28,5	250	59,00	2	009560221
13/16					

## 957

chaves em T para velas com cardan

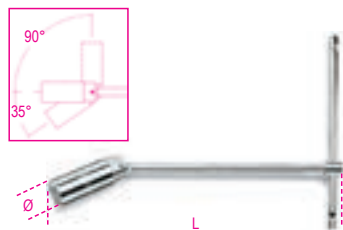

ISO 11168

mm -"	Ø mm	L mm	€	🔧	📦
16	21,4	275	40,50	3	009570000
5/8					
20,8	27,0	275	47,50	3	009570001
13/16					

## 959

chaves em T para velas com cardan série normal

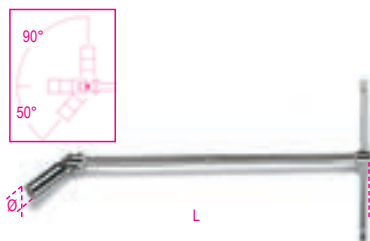

ISO 11168

mm -"	Ø mm	L mm	€	🔧	📦
14	18,8	483	47,00	3	009590009
9/16					
16	21,4	483	52,00	3	009590010
5/8					
20,8	27,0	527	68,50	3	009590011
13/16					

## 959R

aplicações em borracha e molas de substituição para artigos 956C - 956E - 957 - 959

	€	🔧	📦
959R/14 956C/14-956E/14	4,60	3	009590223
959R/16 956C/16-956E/16 957/16-959/16	4,60	3	009590224
959R/17,8 956C/17,8-956E/17,8	4,60	3	009590225
959R/20,8 956C/20,8-956E/20,8 957/20,8-959/20,8-959L	4,60	3	009590226

## 960

chave de caixa para injectores de motores Diesel, quadra fêmea de 1/2"



mm	Ø mm	L mm	€	🔧	📦
27	36,5	77	30,00	2	009600027

## 960A

chave de caixa para injectores de motores Diesel, quadra fêmea de 1/2"

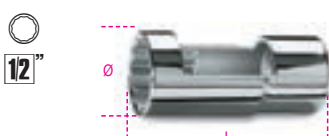

mm	Ø mm	L mm	€	🔧	📦
27	36,5	77	43,50	2	009600017

## 960BT

Chave para ligações eléctricas de injectores

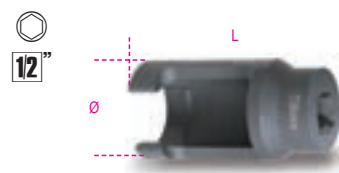

mm	Ø mm	L mm	€	🔧	📦
25	37,0	78	73,50	1	009600125
27	39,7	78	73,50	1	009600127
29	42,0	78	73,50	1	009600129
30	43,0	78	73,50	1	009600130

## 960BT/B

chave de caixa para conectores eléctricos do injector

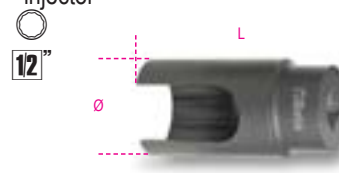

mm	Ø mm	L mm	€	🔧	📦
29	38,5	77	106,00	1	009600128

## 960F

chave de caixa para porta-injectores



Ø mm	Ø1 mm	Ø2 mm	Ø1 mm	€	🔧	📦
28,3	22	32	22	34,50	1	009600148

## 960G

chave de caixa para injectores especialmente indicada para os injectores Diesel dos camiões Mercedes-Benz

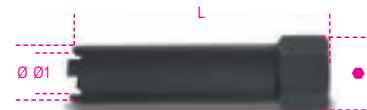

Ø mm	Ø1 mm	Ø mm	L mm	€	🔧	📦
28,5	22	32	122	37,00	1	009600151

## 960L

chave de caixa para injectores

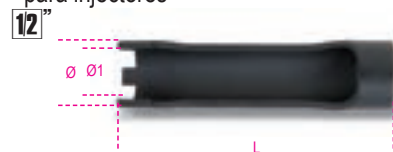

Ø mm	Ø1 mm	L mm	€	🔧	📦
30	22	122	40,00	1	009600153

## 960M

chave de caixa para injectores

12"

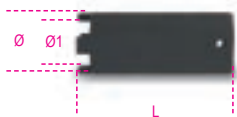

Ø mm	Ø1 mm	L mm	€	U	W
28,5	22	72	29,00	1	009600154

## 960H/C4

jogo de chaves de caixa para porta-injectores



960H/C4	€	U	W
	102,50	1	009600152

## 960S

chave de caixa para injectores de motores Diesel, quadra fêmea de 1/2"

12"



Ø mm	Ø mm	L mm	€	U	W
22	30	82	34,00	1	009600022

## 960SL

chaves de caixa para sonda Lambda com quadra fêmea de 1/2"

12"



Ø mm	€	U	W
960SL85 ○ 22xL= 85 mm	52,00	2	009600085
960SL110 ○ 22xL= 110 mm	59,50	2	009600110

## 960SN

chaves para velas de incandescência de motores Diesel

14"

3/8"



Ø mm	Ø mm	□	L mm	€	U	W
8	12,0	1/4	60	45,00	2	009600834
9	13,3	1/4	60	45,00	2	009600835
10	14,5	3/8	70	52,50	2	009600836
11	15,8	3/8	70	52,50	2	009600837
12	17,0	3/8	70	52,50	2	009600838

## 960/22EP

chave dupla articulada, para sondas Lambda  
Cabeça dupla sextavada/bi-sextavada e junta 180° para extrema versatilidade



L mm	Ø mm	Ø mm	€	U	W
300	22	22	47,50	1	009600052

## 960AVE

dispositivo de teste de injectores eléctricos diesel commom rail



960AVE	€	U	W
	229,00	1	009600245

430x310x50 mm - 2,0 kg

## 960CMB

compressómetro para motores a gasolina



Bar	€	U	W
4÷17	551,00	1	009600250

440x370x100 mm - 2,2 kg

## 960CMB/R2

cartões de substituição para artigo 960CMB



960CMB/R2	€	U	W
	28,00	1	009600252

## 960CMD

compressómetro para motores Diesel



Bar	€	U	W
8÷40	600,00	1	009600270

440x370x100 mm - 2,4 kg

## 960CMD/R1

cartões de substituição para artigo 960CMD



960CMD/R1	€	U	W
	28,00	1	009600271

## 960EPC

jogo de ferramentas para remoção de eléctrodos de velas de incandescência



ZONA DI ROTTURA

960EPC	€	U	W
	555,00	1	009600790

270x230x80 mm - 900 g

# Beta

## 960E-PI/P

extractor de anilhas de injector

- Rosca macho M10 para utilização com o extractor de percussão (Beta 1540)



960E-PI/P € 58,50 1 009600706  
300x90x60 mm

## 960KC-M8/M9/M10

Jogo de ferramentas para remoção de velas de incandescência danificadas ou partidas

- Para velas de incandescência com rosca M8-M9-M10



960KC-M8/9/10 € 379,00 1 009600801  
380x290x50 mm - 2,3 kg

## 960KPC

Extractor por impulso reversível com binário ajustável para velas de incandescência

14"



960KPC € 287,00 1 009600780  
8-9-10-11-12 mm  
420x185x60 mm - 2,8 kg

## 960UC

Jogo de ferramentas para extração de velas de incandescência M8-M9-M10 com pontas danificadas



960UC € 442,00 1 009600900

## 960P

aparelho de teste de compressão/descompressão com acessórios e adaptadores



960P € 221,00 1 009600777  
350x320x95 mm - 1,9 kg

## 960PI

jogo de escareadores para limpeza do alojamento dos injectores em estojo de plástico

Para remover resíduos do alojamento do injector

- Escareador plano, Ø 19 - 15 mm, para injectores universais
- Escareador plano, Ø 17 - 17 mm, para injectores Delphi/Bosch (BMW/PSA/Renault/Ford)
- Escareador plano, Ø 19 - 17 mm, para injectores Bosch (Mercedes CDI).
- Escareador angular, Ø 21 - 17 mm, para injectores Fiat/Iveco
- Punho



960PI € 107,00 1 009600215  
250x130x50 mm - 600 g

## 960PI/C19

jogo de 19 ferramentas para limpeza de base de injectores

Inclui:

- 11 mandris planos, Ø: 14/14 mm - 15,5/15,5 mm - 15/19 mm - 17/19 mm - 17/17,5 mm - 17/19 mm - 17/19,5 mm - 17/20 mm - 18/21 mm - 19 mm - 20/21 mm
- 4 mandris angulares, Ø: 15,5/15,5 mm - 17/17 mm - 17,5/20,5 mm - 17/21 mm
- Acessórios para mandris e punhos



960PI/C19 € 262,00 1 009600217  
360x230x60 mm

## 960PI/S

kit limpeza do alojamento dos injectores

Inclui:

- 3 escovas de aço, Ø 18, 22, 25 mm, para limpeza de suportes de injectores
- 2 escovas, Ø 14 e 16 mm para limpeza do fundo dos suportes
- 6 tampas para o acesso à câmara de combustão
- 1 escova para limpeza do acesso à câmara de combustão
- 1 porta-bits flexível com punho

14"



960PI/S € 137,00 1 009600214  
360x140x50 mm - 700 g

## 960RPI

Soprador do alojamento dos injectores

Para velas de incandescência M8x1 - M9x1 - M10x1 - M10x1.25



960RPI € 169,00 1 009600940

## 960PMC

bomba manual para regulação e controlo de injectores Diesel



Bar Max. 400 € 671,00 1 009600200

## 960AVL

aspirador de fumos



Bar Max. 6 € 753,00 1 009600210

## 961D

videoscópio electrónico digital com sonda 5.5 mm

• Permite registar imagens individuais e vídeo clips, reproduzindo-os directamente na ferramenta



- sonda com cabeça Ø 5.5 mm e 90 cm de comprimento
- monitor TFT LCD, 7" (18 cm), com resolução 800x480
- câmara digital com visão frontal e lateral
- união rápida da sonda tipo "Cfast"
- frequência de repetição da imagem: 15 frames por segundo
- zoom digital 2x
- porta micro-USB para upload de imagens
- saída de vídeo micro-HDMI
- porta para cartão micro-SD
- porta micro-USB
- possibilidade de utilização durante o carregamento da bateria
- microfone e altifalante para registar/ouvir anotações de voz
- ligação Wi-Fi

961D € 1.535,00 1 009610500

400x340x85 mm - 2,6 kg

## 961D/CF3,8

sonda 1m com câmara frontal 3.8 mm para videoscópio 961D



961D/CF3,8 € 654,00 1 009610511

## 961D/DC8,5

sonda 1m com câmara UV dupla para videoscópio 961D



961D/DC8,5 € 567,00 1 009610513

## 961P6

videoscópio electrónico com sonda flexível



- Suporta cartões SD (8 GB)
  - Suporta memórias flash (8 GB)
  - Memória interna: 128M
  - Saída para TV
  - Suporta formato de vídeos (MP4, AVI, 3GP)
  - 4 LEDs
  - Alimentação por porta USB (bateria embutida)
- ESPECIFICAÇÕES**
- Pixels do sensor: 640x480
  - Resolução máxima: 320x240
  - Comprimento da sonda: 1 m
  - Diâmetro da câmara: 6 mm
  - Formato de vídeos: MPEG4, 3GP, AVI, ASF
  - Formato de fotografias: JPEG
  - Ângulo de disparo: 0±180°
  - Saída de dados: Cabo USB e cartão SD
  - Alimentação: bateria 3.7V 2000 mAh

961P6 € 653,00 1 009610000

# Beta

## 961P6/S

sondas flexíveis, 6 mm



Model	L mm	€	QTY	Code
961P6/S2	2000	314,00	1	009610262
961P6/S3	3000	358,00	1	009610263

## 962

ferros de desmonta



L mm	A mm	€	QTY	Code
300	21	21,30	5	009620003
400	25	25,00	5	009620004
500	27	33,00	3	009620005
600	27	42,00	3	009620006

## 962P

alavanca de pneus com proteção anti-riscos



L mm	A mm	€	QTY	Code
490	25	78,50	1	009620049

## 962M

ferramenta para desmontagem/ montagem de pneus

Instalação de pneus runflat e baixo perfil em todos os equipamentos.

- mordentes anti-riscos
- base de alavanca para remoção do pneu



962M € 284,00 1 009620501

## 963

alavanca com extremidades chata e pontiaguda



L mm	A mm	€	QTY	Code
400	23	32,50	5	009630001

## 964

alavanca com extremidades pontiaguda e em cunha



L mm	A mm	€	QTY	Code
400	46	29,50	5	009640001

## 965

jogo de alavancas com pontas curvadas



L	A	L1	€	🔧	📄
300	16	185	14,80	2	009650013
450	20	312	21,00	2	009650014
600	20	462	24,60	2	009650016

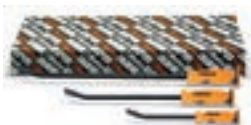

965/S3	€ 60,00	🔧 1	📄 009650019
--------	---------	-----	-------------

## 966/C3

Jogo 3 alavancas com cabeça articulada curvada

- Rotação da cabeça a 200°
- Bloqueio automático na posição pretendida



966/C3	€ 112,00	🔧 1	📄 009660103
--------	----------	-----	-------------

L=200-250-300 mm

355x140x65 mm - 1,8 kg

## 720LS

chaves de impacto, série longa



UNI/ISO 2725

mm	Ø	L	Ø1	€	🔧	📄
720LS 36	36	48,0	78	29	2	007200386

## 969B

chave de caixa para aperto da porca do cubo

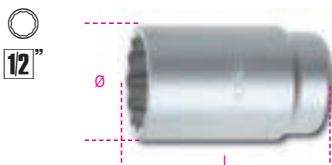

mm	Ø	L	€	🔧	📄
24	36,0	76	18,60	1	009690124
27	36,0	76	18,60	1	009690127
30	40,0	76	19,70	1	009690130
31	42,0	76	19,70	1	009690131
32	42,5	76	20,80	1	009690132
34	45,0	76	23,50	1	009690134
35	46,0	76	24,00	1	009690135
36	49,0	76	27,50	1	009690136

## 969/C5

jogo de 5 chaves de caixa para cubos de roda em estojo de plástico

12"



969/C5	€ 115,00	🔧 1	📄 009690201
--------	----------	-----	-------------

969B 30-32-34-35-36

## 970EA

chave de impacto para cubos de roda

3/4"



mm	mm	Ø	€	🔧	📄
98	36	122	221,00	1	009700398

## 970EB

chave de impacto para cubos de roda

12"



mm	mm	Ø	€	🔧	📄
95	36	126	259,00	1	009700595
110	36	133	264,00	1	009700410

## 970Q

chave de impacto para porcas rectangulares

3/4"



L	mm	€	🔧	📄
56	3/4"	100,50	1	009700756
60	3/4"	106,00	1	009700760

## 970B

chave de caixa para aperto da porca do cubo Fiat Daily

1"

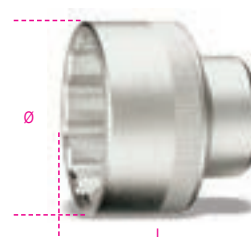

mm	Ø	L	€	🔧	📄
65	88	75	94,00	1	009700010

## 970C

chave de caixa octogonal para aperto de cubos de roda



mm	□ - Ø	€	🔧	📄
80	41 mm	142,00	1	009700808
95	3/4"	202,00	1	009700815
100	3/4"	208,00	1	009700820
109	41 mm	213,00	1	009700829
115	3/4"	213,00	1	009700835
120	41 mm	218,00	1	009700840

## 970OT

chave de caixa oval para aperto de cubos de rodas de trailers



L	L1	□ - Ø	€	🔧	📄
65	61	3/4"	123,00	1	009700165
80	73	3/4"	140,00	1	009700180
96	90	3/4"	152,00	1	009700196
111	104	41 mm	199,00	1	009700211



## 971TSP

sensor de pressão para pneus



### ESPECIFICAÇÕES

- leitura do sensor TPMS, incluindo: sensor ID
- impressão de enchimento
- temperatura
- estado da bateria
- activação do sensor
- programação universal do sensor

A ferramenta possui uma base de dados que suporta operações de reparação, nomeadamente:

- torques
- códigos das peças originais e sensores universais compatíveis

971TSP	€ 1.080,00	1	009710025
63x142x30 mm			

## 971/C8

chave de aperto para válvulas de pneus, com acessórios e sistema de controlo de pressão para um aperto controlado



971/C8	€ 354,00	1	009710108
--------	----------	---	-----------

	583/6	1,2±6 Nm
	892/0	
	862TX	T10-T15-T20
	900L	11-12 mm
	986 78	

## 978 - 979

chaves de cruz para porcas de rodas

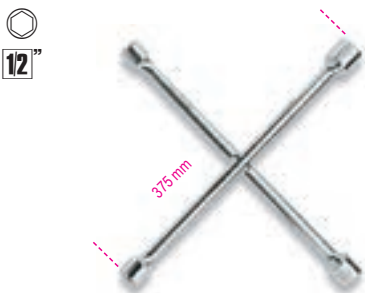

UNI/ISO 6788 DIN 3119

978	€ 57,00	2	009780001
17x19x21x22 mm			
979	€ 57,00	2	009790001
17x19x22x1/2 mm			

## 982

chaves de cruz para porcas de rodas

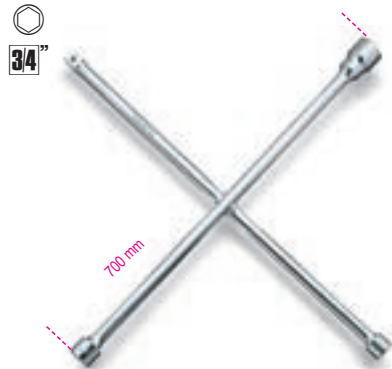

UNI/ISO 6788 DIN 3119

24x27x32x3/4 mm	€ 137,00	1	009820001
-----------------	----------	---	-----------

## 984

Alicate para tampa de plástico da porca da roda



L mm	H mm	€	1	009840005
195	4	21,80		

## 985/B7

jogo 7 pinos-guia para rodas

Tamanhos:

- M12x1.25 macho
- M12x1.25 fêmea
- M12x1.5 macho
- M12x1.5 fêmea
- M14x1.25 macho
- M14x1.5 macho
- M16x1.5 macho



985/B7	€ 89,00	1	009850007
--------	---------	---	-----------

## 985M

pinos-guia macho para rodas



	L mm	€	1	
985M M12X1,25	150	10,90	1	009850101
985M M12X1,50	150	10,90	1	009850102
985M M14X1,25	150	11,50	1	009850103
985M M14X1,50	150	11,50	1	009850104
985M M16X1,50	150	12,60	1	009850105

## 985F

pinos-guia fêmea para rodas



	L mm	€	1	
985F M12X1,25	150	14,80	1	009850106
985F M12X1,50	150	15,90	1	009850107

## 986 48

Chave de fendas para válvulas de pneus, modelo curto

Válvula de retenção automática

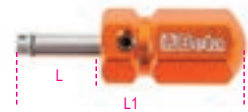

L mm	L1 mm	€	1	009860048
18	48	12,60		

## 986 78

Chave de fendas para válvulas de pneu

Válvula de retenção automática



L mm	L1 mm	€	1	009860078
18	78	12,60		

## 986PT

chave para válvulas de pneus, pré-calibrada, 0.4 Nm, retenção automática da válvula

Mecanismo de proteção da calafetagem da válvula



L mm 19 L1 mm 120 € 46,00 1 009860140

## 987

Alavanca para válvulas de pneus com protecção em borracha



L mm 310 € 25,50 1 009870001

## 987AR

alavanca para válvulas de pneus com apoio anti-riscos

- apoio em borracha e nylon para jantes de liga e de ferro
- encaixe rápido da válvula, sem necessidade de apertar



L mm 305 € 90,50 1 009870021

## 987P

alavanca para válvulas de pneus em plástico

Punho permite trabalhar com a chave no mecanismo interno da válvula



L mm 335 € 21,80 1 009870011

 Beta

## 988/K4

Jogo de 4 escopros planos anti-riscos em plástico

- Particularmente adequados para remoção de vedantes adesivos em jantes de liga leve
- Arestas de corte em 3 lados para utilização mais versátil



988/K4 € 23,50 1 009880104  
A= 19-21-25-38 mm

## 989

alicate para pesos



L mm 250 € 43,00 2 009890001

## 990

pinça de pontas finas, direitas e estriadas em aço inoxidável



L mm 130 € 10,40 5 009900001

## 991

pinça de pontas finas, curvas e estriadas em aço inoxidável



L mm 130 € 12,60 5 009910001

## 992

pinça com guia, pontas finas direitas e estriadas em aço inoxidável



L mm 150 € 13,60 5 009920001

## 993

pinça com guia, pontas finas curvas e estriadas em aço inoxidável



L mm 145 € 14,70 5 009930001

## 993PL

pinça com guia, pontas finas curvas e estriadas em aço inoxidável cobertura em PVC



L mm 150 € 14,70 3 009930010

## 993G

pinça com guia, pontas finas, encurvadas e estriadas em aço inoxidável



L mm 160 € 13,10 3 009930030

## 994

pinça com pontas largas, direitas e estriadas em aço inoxidável



L mm 150 € 10,90 5 009940001

 Beta

### 994PL

pinça com pontas largas, direitas e estriadas em aço inoxidável cobertura em PVC



L mm 150 € 13,10 3 009940010

### 994TF

pinça com pontas largas, direitas e estriadas em aço inoxidável anti-magnético e resistente a ácidos



L mm 150 € 17,50 3 009940020

### 996

pinça com pontas direitas espatuladas em aço inoxidável



L mm 150 € 11,60 5 009960001

### 998

pinça cruzada de pontas largas, direitas e estriadas em aço inoxidável



L mm 155 € 20,40 5 009980001

### 999

pinça com pontas chatas e arredondadas em aço inoxidável anti-magnético e resistente a ácidos



L mm 115 € 15,90 3 009990011

### 999A

pinça com pontas curtas e extra-finas em aço inoxidável anti-magnético e resistente a ácidos



L mm 120 € 14,20 3 009990015

### 999B

pinça com pontas direitas de grande resistência em aço inoxidável anti-magnético e resistente a ácidos



L mm 120 € 14,20 3 009990017

### 999C

pinça com pontas direitas e extra-finas em aço inoxidável anti-magnético e resistente a ácidos



L mm 110 € 15,30 3 009990019

### 999D

pinça com pontas extra-finas angulares em aço inoxidável anti-magnético e resistente a ácidos



L mm 115 € 17,10 3 009990021

### 999E

pinça com pontas curvas extra-finas em aço inoxidável anti-magnético e resistente a ácidos



L mm 120 € 15,30 3 009990023

### 999G

pinça de pontas direitas extra-finas com dispositivo de bloqueio em aço inoxidável anti-magnético e resistente a ácidos



L mm 140 € 15,30 3 009990027

### 999/B6

jogo de 6 pinças, resistentes a ácidos e campos magnéticos



999/B6 € 98,50 1 009990050  
999-999A-999B  
999C-999D-999E

### 1002

pinça de pontas redondas estriadas com bloqueio, em aço inoxidável



L mm 160 € 25,50 2 010020001

### 1008

alicate de pontas chatas longas, com estrias, e punhos de dupla camada de PVC



ISO 5745

L mm 160 L1 mm 51,5 € 22,60 5 010080006

### 1008BM

alicate de pontas chatas longas, com estrias, e punhos bi-material



ISO 5745

L mm 160 L1 mm 51,5 € 28,00 3 010080036

## 1009

alicates de pontas estriadas extra-longas, punhos com dupla camada de PVC anti-deslizamento



L mm	L1 mm	€	Hand	Weight
160	56,5	22,60	2	010090006

## 1009L/A

alicate para trabalhos especiais de pontas semi-redondas extra-longas, com estrias, e punhos de dupla camada de PVC



L mm	L1 mm	€	Hand	Weight
283	80	27,00	2	010090008

## 1009L/B

alicate para trabalhos especiais de pontas semi-redondas extra-longas, curvas a 45°, com estrias, e punhos de dupla camada de PVC



L mm	L1 mm	€	Hand	Weight
273	73	28,00	2	010090009

## 1009L/C

alicate para trabalhos especiais de pontas semi-redondas extra-longas, curvas a 90°, com estrias, e punhos de dupla camada de PVC



L mm	L1 mm	€	Hand	Weight
253	45	29,50	2	010090010

## 1009L/D

alicate extralongo, nariz dentado duplo giratório, pegas com revestimento duplo em PVC antiderrapante



L mm	L1 mm	€	Hand	Weight
342	71	33,00	1	010090058

## 1009L/DP

alicate curva extralongo nariz dentado duplo giratório, 45°, pegas com revestimento duplo em PVP antiderrapante



L mm	L1 mm	€	Hand	Weight
336	66	33,00	1	010090059

## 1010

alicate de pontas redondas extra-longas e punhos de dupla camada de PVC



ISO 5745

L mm	L1 mm	€	Hand	Weight
160	51,5	22,60	2	010100006

## 1010BM

alicate de pontas redondas, com estrias, e punhos bi-material



ISO 5745

L mm	L1 mm	€	Hand	Weight
160	51,5	28,00	2	010100036

## 1031/S4

Jogo de 4 alicates de freios



1031/S4	€	Hand	Weight
1032 180	97,50	1	010310000
1034 170			
1036 175			
1038 175			

## 1032

alicates de freios interiores com pontas direitas e punhos em PVC



UNI 7914 DIN 5256

L mm	Ø mm	€	Hand	Weight
140x0,9	8÷12	21,50	5	010320013
140x1,3	12÷25	21,00	5	010320014
180	19÷60	22,60	5	010320017
225	40÷100	28,00	3	010320021
300	85÷200	39,50	2	010320028

## 1033

alicates de freios interiores com pontas curvas a 45° e punhos em PVC



UNI 7914 DIN 5256

L mm	Ø mm	€	Hand	Weight
140x0,9	8÷12	24,40	5	010330013
140x1,3	12÷25	23,80	5	010330014
180	19÷60	24,90	5	010330017
225	40÷100	32,00	3	010330021

## 1034

alicates de freios interiores com pontas curvas a 90° e punhos em PVC



UNI 7914 DIN 5256

L mm	Ø mm	€	Hand	Weight
130x0,9	8÷12	24,40	5	010340013
130x1,3	12÷25	23,80	5	010340014
170	19÷60	24,90	5	010340017
210	40÷100	32,00	3	010340021
290	85÷200	43,00	2	010340028

### 1034L

alicate de freios interiores com pontas curvas a 90° e punhos em PVC



L mm	∅ mm	€	🔧	📦
190	40÷100	62,50	2	010340320

### 1036

alicates de freios exteriores com pontas direitas e punhos de PVC



UNI 7915 DIN 5254

L mm	∅ mm	€	🔧	📦
140x0,9	3÷10	23,80	5	010360013
140x1,3	10÷25	22,60	5	010360014
175	19÷60	23,80	5	010360017
225	40÷100	30,00	3	010360021
300	85÷200	47,00	2	010360028

### 1037

alicates de freios exteriores com pontas curvas a 45° e punhos em PVC



UNI 7915 DIN 5254

L mm	∅ mm	€	🔧	📦
140x0,9	3÷10	26,00	5	010370013
140x1,3	10÷25	24,90	5	010370014
175	19÷60	26,00	5	010370017
225	40÷100	32,50	3	010370021

### 1038

alicates de freios exteriores com pontas curvas a 90° e punhos em PVC



UNI 7915 DIN 5254

L mm	∅ mm	€	🔧	📦
135x0,9	3÷10	26,00	5	010380013
135x1,3	10÷25	24,90	5	010380014
175	19÷60	26,00	5	010380017
220	40÷100	32,50	3	010380021
300	85÷200	50,00	2	010380028

### 1039

alicate reversível com pontas direitas para freios interiores e exteriores com punhos em PVC



L mm	∅ mm	∅ mm	€	🔧	📦
150	10÷15	6÷25	54,00	2	010390015

### 1558/C4

ferramenta para anel retentor interno e externo, operada por parafuso

Encabudo quadrado permite a aplicação de uma força elevada em ambas as condições de operação  
Pontas fornecidas:  
∅ 2.5-3-3.5 mm



∅ mm	∅ mm	€	🔧	📦
1558/C4 5,5 ÷ 77	5,5 ÷ 77	144,00	1	015580100

330x220x50 mm - 900 g

### 1044

alicate ajustável charneira sobreposta punhos com revestimento duplo em PVC antiderrapante

· novo modelo com 9 posições



ISO 8976

L mm	A max mm	L1 mm	€	🔧	📦
250	48	39	30,00	5	010440250

### 1044F

alicate ajustável charneira sobreposta punhos com revestimento em PVC

· novo modelo com 9 posições



ISO 8976

L mm	A max mm	L1 mm	€	🔧	📦
250	48	39	23,50	5	010440015

### 1046

alicate ajustável de charneira com cremalheira sobreposta e punhos em PVC

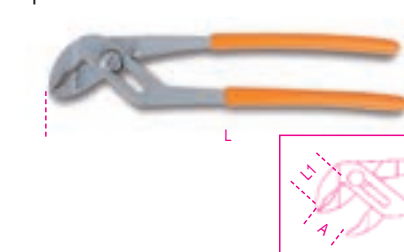

ISO 8976

L mm	A max mm	L1 mm	€	🔧	📦
240	28	33	34,00	5	010460240
400	107	55	58,00	1	010460400

### 1047

alicate ajustável de charneira fechada, com botão de bloqueio punhos com revestimento duplo em PVC antiderrapante



L mm	A max mm	L1 mm	€	🔧	📦
180	30	29	39,50	2	010470180
240	36	35	41,50	2	010470240
300	50	48	61,50	1	010470300

### 1047BM

alicate de charneira, botão de regulação, punho de 2 componentes

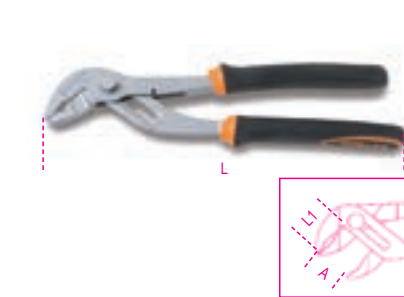

L mm	A max mm	L1 mm	€	🔧	📦
240	36	35	48,00	2	010470340

# Beta

## 1048

alicate ajustável de charneira fechada punhos revestidos a PVC

• Modelo de 9 posições

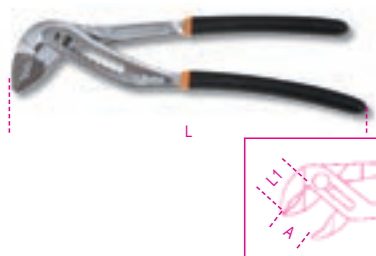

ISO 8976

L mm	A max mm	L1 mm	€	🔧	📦
175	30	29	29,00	3	010480010
250	48	39	32,00	5	010480015
300	56	47	46,50	2	010480020

## 1048BM

alicate ajustável, charneira fechada, punhos de 2 componentes

• novo modelo com 9 posições



L mm	A max mm	L1 mm	€	🔧	📦
250	48	39	41,00	3	010480215

## 1048V

alicate ajustável de charneira fechada, lacado cor de laranja

• novo modelo com 9 posições

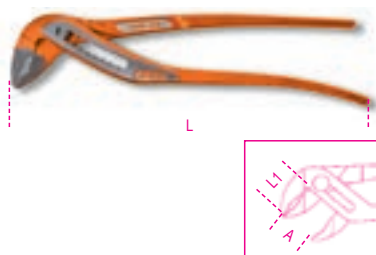

ISO 8976

L mm	A max mm	L1 mm	€	🔧	📦
175	30	29	24,20	3	010480110
250	48	39	28,00	5	010480115
300	56	47	41,00	2	010480120

## 1050

alicate de pressão com dupla regulação



L mm	€	🔧	📦
220	70,50	2	010500022

## 1051

alicate de pressão com dupla regulação maxilas longas

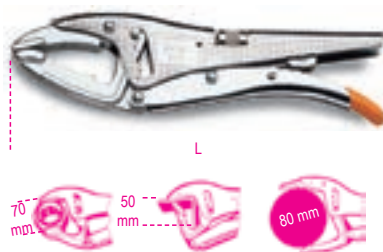

L mm	€	🔧	📦
255	77,00	2	010510025

## 1051GM

alicate de pressão com dupla regulação, maxila oscilante

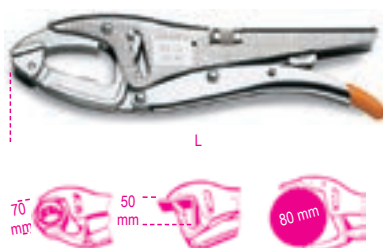

L mm	€	🔧	📦
255	82,00	2	010510250

## 1051L

alicate de pressão de grande capacidade com dupla regulação

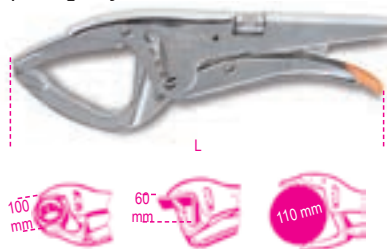

L mm	€	🔧	📦
270	88,50	2	010510100

## 1051XL

alicate de pressão de grande capacidade com dupla regulação, mordentes extra-longos



L mm	€	🔧	📦
270	105,50	2	010510140

## 1052

alicates de pressão, maxilas côncavas



L mm	A1 max mm	€	🔧	📦
140	22	23,50	3	010520014
190	36	26,50	3	010520019
240	42	28,00	3	010520024
300	55	47,50	2	010520030

## 1053

alicates de pressão, maxila oscilante

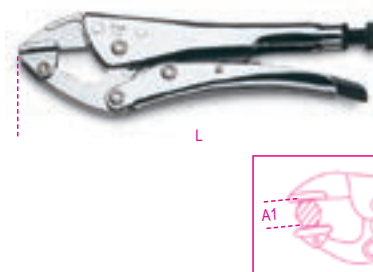

L mm	A1 max mm	€	🔧	📦
240	35	40,00	2	010530024

## 1054

alicate de pressão, maxilas direitas



L mm	A1 max mm	€	🔧	📦
235	40	34,50	2	010540022



### 1055

alicate de pressão, maxilas recurvadas

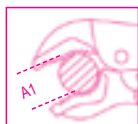

L mm	A1 max mm	€	U	U
250	60	36,00	2	010550024

### 1057A

alicate ajustável com sistema autoblocante



L mm	€	U	U
240	50,50	2	010570124

### 1058

alicates de pressão, bicos longos

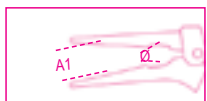

L mm	A1 max mm	Ø max mm	€	U	U
180	35	22	29,50	2	010580018
240	50	35	40,50	2	010580024
310	65	40	47,00	2	010580031

### 1060

alicate de pressão para soldadura

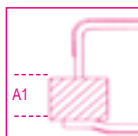

L mm	A1 max mm	€	U	U
200	50	37,50	2	010600020
280	80	48,00	2	010600028

### 1061

alicate de pressão para soldadura

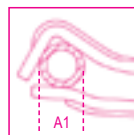

L mm	A1 max mm	€	U	U
290	80	52,50	2	010610028

### 1062

alicates de pressão pescoço de cisne

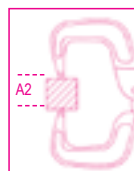

L mm	A1 max mm	€	U	U
170	50	29,00	2	010620017
290	120	39,00	2	010620029
460	250	67,50	1	010620046

### 1062AL

alicate de pressão pescoço de cisne, maxilas em alumínio



L mm	A1 max mm	€	U	U
290	104	51,00	2	010620329

### 1062GM

alicate de pressão pescoço de cisne, maxilas oscilantes

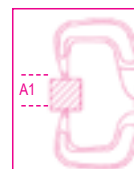

L mm	A1 max mm	€	U	U
170	45	32,50	2	010620217
290	88	45,00	2	010620229
460	260	81,00	1	010620246

### 1063

alicate de pressão para latoeiros



L mm	A1 max mm	€	U	U
200	30	50,50	2	010630020

### 1064

alicate de pressão com corrente



L mm	Ø mm	€	U	U
240	150	74,00	2	010640024

### 1065F

alicate de furar chapa

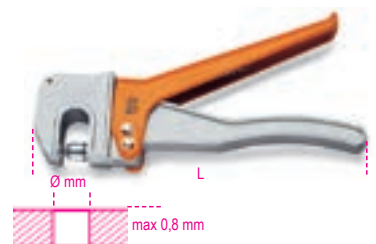

Ø mm	L mm	€	U	U
5	228	105,00	1	010650010
6	228	106,00	1	010650015

## 1065P

alicate de dobrar chapa

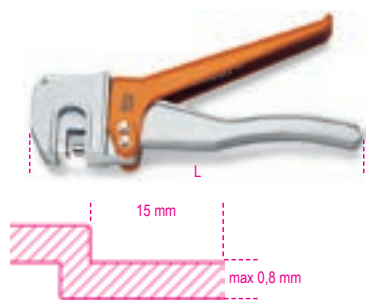

L mm	€	🔧	📦
228	108,00	1	010650020

## 1077

alicate de latoeiro com pontas largas e direitas, punhos com cobertura em PVC



L mm	A mm	L1 mm	€	🔧	📦
280	60	53	47,00	1	010770026

## 1078

alicate de latoeiro com pontas largas e curvas a 45°, punhos com cobertura em PVC



L mm	A mm	L1 mm	€	🔧	📦
280	60	77	48,00	1	010780026

## 1080D

alicate de corte diagonal raso com punhos com revestimento duplo em PVC

Para corte de plástico

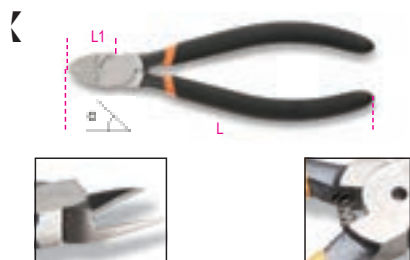

α	L mm	L1 mm	€	🔧	📦
15°	160	22	24,80	3	010800015
45°	160	22	30,00	3	010800045

## 1081

Alicate de corte, punho anti-derrapante com revestimento duplo em PVC

• Para eletrônica e trabalhos pesados em micromecânica



L mm	L1 mm	€	🔧	📦
125	16	25,00	3	010810130

## 1082

alicates de corte diagonal com punhos de dupla camada em PVC



UNI/ISO 5749

L mm	L1 mm	€	🔧	📦
140	20	22,10	5	010820004
160	22	23,80	5	010820006

## 1082BM

alicates de corte diagonal, punhos bi-material



UNI/ISO 5749

L mm	L1 mm	€	🔧	📦
140	20	27,50	3	010820034
160	22	31,00	3	010820036

## 1084

alicates de corte diagonal para serviços pesados com punhos de dupla camada em PVC



UNI/ISO 5749

L mm	L1 mm	€	🔧	📦
140	20	24,60	5	010840004
160	22	26,00	5	010840006
180	25	32,50	3	010840008
200	28	33,00	3	010840010

## 1084BM

alicates de corte diagonal para serviços pesados punhos bi-material



UNI/ISO 5749

L mm	L1 mm	€	🔧	📦
140	20	30,00	3	010840034
160	22	32,50	3	010840036
180	25	39,50	3	010840038
200	28	41,00	3	010840040

## 1088

alicates de corte frontal para serviços pesados com punhos de dupla camada em PVC



UNI/ISO 5748

L mm	L1 mm	€	🔧	📦
160	9	32,50	2	010880006
200	11	41,00	2	010880010

## 1088BM

alicates de corte frontal para serviços pesados, punhos bi-material



UNI/ISO 5748

L mm	L1 mm	€	🔧	📦
160	9	39,00	2	010880036
200	11	51,50	2	010880040





## 1092V

alicates de corte frontal articulados, serviço pesado

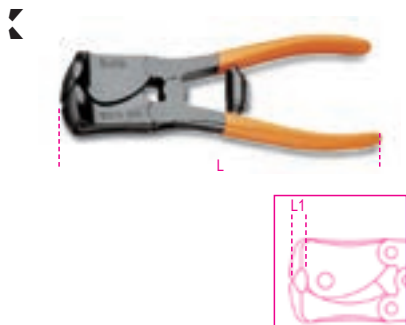

UNI/ISO 5748

L	L1	Ø	€	U	PC
mm	mm	mm			
180	8	2,0	128,00	2	010920280
200	9	2,5	135,00	2	010920310

## 1094V

alicate de corte diagonal articulados, serviço pesado



UNI/ISO 5749

L	L1	Ø	€	U	PC
mm	mm	mm			
200	23	2,5	128,00	2	010940200

## 1095N

alicate de corte diagonal



L	L1	Ø	€	U	PC
mm	mm	mm			
195	26	1,6	45,50	2	010950010

## 1096

tenazes de carpinteiro



ISO 9243

L	L1	€	U	PC
mm	mm			
160	21	17,50	5	010960016
200	23	20,20	5	010960020
250	30	27,00	5	010960025

## 1098

turquês para cofragens

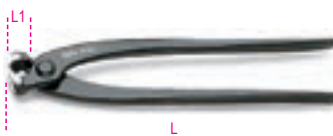

ISO 9242 DIN 5242

L	L1	€	U	PC
mm	mm			
190	12	17,50	5	010980190
220	13	19,70	5	010980220
250	15	22,90	5	010980250
280	18	25,00	5	010980280

## 1098PL

turquês para cofragens punhos revestidos a PVC



ISO 9242 DIN 5242

L	L1	€	U	PC
mm	mm			
220	13	21,30	5	010980320
250	15	24,60	5	010980350
280	18	27,00	5	010980380

## 1101

corta-parafusos



L	L	€	U	PC
mm	mm			
300	12	51,00	2	011010030
350	14	62,50	2	011010035
450	18	76,50	1	011010045
600	24	105,50	1	011010060
750	30	136,00	1	011010075
900	36	181,00	1	011010090

L	R = 80	R = 140	g	U
mm	Kgf/mm²	Kgf/mm²		
	Ø mm	Ø mm		
300	5	4	745	2
350	6	5	1043	2
450	7	6	1537	1
600	9	7	2540	1
750	11	8	3870	1
900	12	9	6170	1

## 1101R

lâminas de substituição para o modelo 1101



mm	1101	€	U	PC
300	300	31,00	1	011010130
350	350	35,50	1	011010135
450	450	44,50	1	011010145
600	600	61,50	1	011010160
750	750	76,00	1	011010175
900	900	99,50	1	011010190

## 1102

corta-parafusos

R= 80 Kgf/mm²



L	Ø	€	U	PC
mm	mm			
230	4	38,00	3	011020020

## 1104

corta cabos de aço para serviços pesados, com punhos em material termoplástico



R=80 Kgf/mm²

L	Ø	€	U	PC
mm	mm			
420	12	131,00	1	011040004
600	16	192,00	1	011040006

## 1104R

lâminas de substituição para artigo 1104



mm	€	U	PC
420	79,50	1	011040014
600	114,00	1	011040016

Beta

Beta

## 1105

vazador de juntas

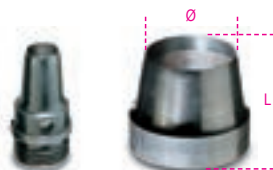

D mm	L mm	€	🔧	📦
2	27	12,90	1	011050002
3	27	12,90	1	011050003
4	27	12,90	1	011050004
5	27	12,90	1	011050005
6	27	12,90	1	011050006
7	27	12,90	1	011050007
8	27	12,90	1	011050008
9	27	12,90	1	011050009
10	27	12,90	1	011050010
12	27	15,70	1	011050012
14	27	15,70	1	011050014
16	27	15,70	1	011050016
18	27	15,70	1	011050018
20	27	15,70	1	011050020
22	32	19,90	1	011050022
24	32	19,90	1	011050024
26	32	19,90	1	011050026
28	32	19,90	1	011050028
30	32	19,90	1	011050030
32	37	25,50	1	011050032
34	37	25,50	1	011050034
36	37	25,50	1	011050036
38	37	25,50	1	011050038
40	37	25,50	1	011050040
42	42	31,50	1	011050042
44	42	31,50	1	011050044
46	42	31,50	1	011050046
48	42	31,50	1	011050048
50	42	31,50	1	011050050

## 1105T30

adaptador para punções 1105,  
3 a 30 mm



L mm	€	🔧	📦
155	139,00	1	011050201

## 1105T50

adaptador para punções 1105  
2 a 50 mm



L mm	€	🔧	📦
155	143,00	1	011050202



## 1105AD-50

adaptador para ref. 1105T50



Ø mm	€	🔧	📦
57	87,50	1	011050210

## 1105/C15T

sortido de 15 punções,  
3 a 30 mm



1105C/15T	€	🔧	📦
	298,00	1	011050251

1105	3 - 4 - 6 - 8 - 10 - 12 - 14 - 16 - 18 - 20 - 22 - 24 - 26 - 28 - 30 mm
1105T30	
📏	230x190x50 mm

## 1105/C29T

sortido de 29 punções,  
2 a 50 mm



1105C/29T	€	🔧	📦
	535,00	1	011050252

1105	2 - 3 - 4 - 5 - 6 - 7 - 8 - 9 - 10 - 12 - 14 - 16 - 18 - 20 - 22 - 24 - 26 - 28 - 30 - 32 - 34 - 36 - 38 - 40 - 42 - 44 - 46 - 48 - 50 mm
1105T50	
1105AD-50	
📏	325x280x55 mm

## 1112

tesoura modelo americano  
lâminas largas e direitas

R=  $\frac{4}{3}$  60 Kg/mm<sup>2</sup>

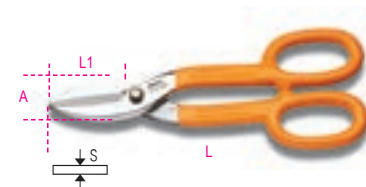

L mm	L1 mm	S mm	A mm	€	🔧	📦
200	50	0,5	26	22,40	2	011120020
250	62	0,8	33	27,00	2	011120025
300	76	1,0	37	35,50	2	011120030
375	76	1,2	44	52,50	1	011120037

## 1114

tesoura de lâminas estreitas e direitas para  
metal mole  
R = 60 Kg/mm<sup>2</sup>

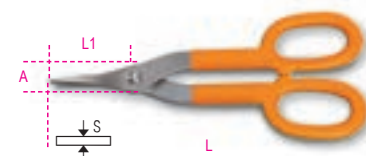

L mm	L1 mm	S mm	A mm	€	🔧	📦
250	58	0,5	15	24,00	1	011140265
350	76	1	22	32,50	1	011140340

## 1118

tesoura para cintas de embalagem

Fe = aço normal  
Inox = aço inoxidável



L mm	L1 mm	Fe S mm	Inox S mm	€	🔧	📦
310	42	1	0,8	39,50	2	011180001

## 1120A

tesoura para cortar metal

Fe = aço macio



L mm	Fe S mm	€	🔧	📦
280	1,2	64,50	1	011200101

## 1120ARL - ARG

peças de substituição para artigo 1120A



1120ARL	€	🔧	📦
	15,30	1	011200110
1120ARG	€	🔧	📦
	19,70	1	011200120

## 1122

tesoura articulada lâminas direitas

Inox = aço inoxidável



## 1123

tesoura articulada de lâminas curvas para contornos a direita

Inox = aço inoxidável

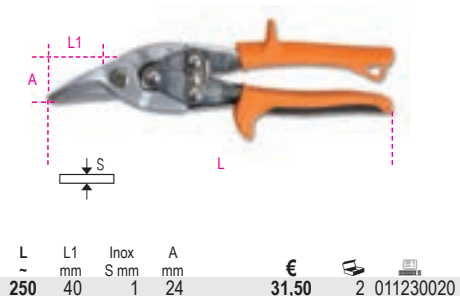

## 1124

tesoura articulada de lâminas curvas para contornos a esquerda

Inox = aço inoxidável

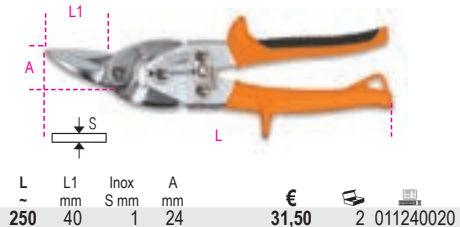

## 1125

tesoura articulada para cortes rectilíneos e contornos a direita

Inox = aço inoxidável

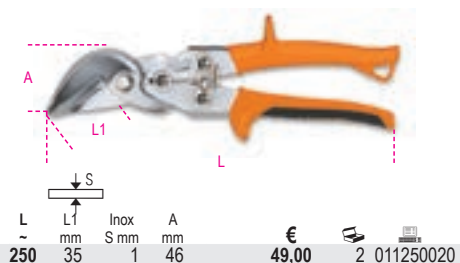

## 1126

tesoura articulada para cortes rectilíneos e contornos a esquerda

Inox = aço inoxidável

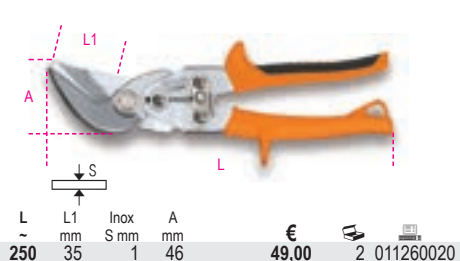

## 1122 - 1125MOL



1122 MOL	1122 - 1124	€	1,35	1	011220010
1123 MOL	1123	€	1,20	1	011230010
1125 MOL	1125 - 1126	€	1,20	1	011250040

## 1127

tesouras para técnico de telefones lâminas direitas



## 1128BAX

Tesoura de electricista com perfis de escareação graduados, lâminas em aço inox com revestimento DLC

Gumes de corte duplo: pino excêntrico especial permite que as lâminas se movimentem a todo o comprimento, aumentando a eficiência de corte.

Concebida para alargar furos em plástico, de 13 mm a 25 mm.

Revestimento DLC (diamond-like carbon) é um revestimento inovador à base de carbono: a elevada dureza e baixo atrito resultam da combinação de carbono, sob a forma de grafite, e diamante.

- Elevada dureza da superfície da lâmina (resistência à abrasão e desgaste)
- Baixa fricção (suavidade e antiaderência)
- Pino excêntrico especial
- Punhos de grandes dimensões com ranhura para corte de cabos e cravagem de terminais
- Com caixa em plástico articulada
- Patentada



L	L1	mm²	€		
150	50	50	28,50	5	011280088

## 1128BCX

tesoura de electricista, lâminas direitas em aço inoxidável, com micro-dentado, ranhura para corte de cabos e alicata para cravagem de terminais

cravagem de terminais: 1÷4 mm² em estojo de plástico



L	L1	mm²	€		
155	55	50	26,00	5	011280080

## 1128BMX

tesoura para electricistas, lâminas direitas em aço inoxidável, com micro-dentes



L	L1	€		
145	54	15,70	5	011280050

## 1128BSX

tesoura de electricista com perfis de escareação graduados, em caixa



L	L1	€		
145	50	27,00	5	011280060

## 1128BM

tesouras de lâminas direitas para electricistas



L	L1	€		
145	50	13,90	5	011280000



### 1129BM

tesouras de lâminas curvas para electricistas



L	L1	€	🔧	📦
mm	mm			
145	44	14,90	5	011290000

### 1130BMX

tesoura multiusos, lâminas direitas em aço inox, com micro-dentado



L	L1	€	🔧	📦
mm	mm			
190	58	25,50	1	011300001

### 1131CK

tesoura para Kevlar® e fibra óptica



L	L1	€	🔧	📦
mm	mm			
203	75	72,00	1	011310001

### 1132

corta-cabos para cabos isolados de cobre e alumínio com punhos de dupla camada em PVC



UNI 8791

L	mm	mm²	€	🔧	📦
170	14	50	43,00	2	011320107
230	18	95	53,00	2	011320113

### 1132BM

corta-cabos para cabos isolados de cobre e alumínio com punhos bi-material



UNI 8791

L	mm	mm²	€	🔧	📦
170	14	50	53,50	2	011320137
230	18	95	66,00	2	011320143

### 1133

corta-cabos para cabos em cobre, flexível

até 325 mm²



L	mm	mm²	€	🔧	📦
600	32	300	150,00	1	011330001

### 1133RL

lâminas de substituição para artigo 1133



1133RL	€	🔧	📦
	112,00	1	011330011

### 1134

corta-cabos com roquete



L	mm	mm	mm²	€	🔧	📦
260	35	400	434,00	1	011340032	

### 1134RL

lâmina de substituição para o modelo 1134



1134RL	€	🔧	📦
	199,00	1	011340132

### 1134A

corta-cabos com roquete



L	mm	mm	mm²	€	🔧	📦
240	45	500	660,00	1	011340045	

### 1134A/RL

lâmina de substituição para modelo 1134A



1134A/RL	€	🔧	📦
	306,00	1	011340145

### 1136

corta cabos de aço

Ø 5 mm cabos com R ≤ 160 kg/mm²  
Ø 4 mm cabos em aço macio



L	mm	€	🔧	📦
165		51,00	2	011360001

### 1142BM

alicate para descarnar fio punhos bi-material



UNI 7923

L	mm	mm²	mm	€	🔧	📦
160	0,5+6	0-2,8	35,50	3	011420036	

### 1143

alicates para descarnar fio com dispositivo de corte



L	mm	mm²	mm	€	🔧	📦
165	1+6	1-3,2	71,50	1	011430001	

### 1143R

lâminas de substituição para artigo 1143

1143R	€	🔧	📦
	18,00	1	011430011



## 1144D

alicate para descarnar cabo



L mm	mm <sup>2</sup>	mm	€	U	U
170	4,5÷240	2,5-18	84,00	1	011440010

## 1144D/RG

gancho de substituição para artigo 1144D



1144D/RG	€ 27,50	U 1	U 011440012
----------	---------	-----	-------------

## 1144D/RL

laminas de substituição para artigo 1144D

1144D/RL	€ 43,50	U 1	U 011440011
----------	---------	-----	-------------

## 1144G

alicate para descarnar cabo

com lâmina ajustável para cortes longitudinais e transversais



L mm	mm <sup>2</sup>	mm	€	U	U
140	6÷75	2,8-12	47,00	1	011440004

## 1144G/RL

lâmina sobresselente para artigo 1144G



1144G/RL	€ 9,75	U 1	U 011440005
----------	--------	-----	-------------

## 1148A

alicates para descarnar fio, com ajuste e dispositivo de corte

10 mm<sup>2</sup> (8 AWG) fios flexíveis  
1,5 mm<sup>2</sup> (16 AWG) fios rígidos



L mm	mm <sup>2</sup>	mm	€	U	U
190	0,02÷10	0-4	144,00	1	011480100

## 1148A/R

lâminas para artigo 1148A



1148A/R	€ 62,00	U 1	U 011480102
---------	---------	-----	-------------

## 1148B

alicates para descarnar fio, com ajuste e dispositivo de corte

10 mm<sup>2</sup> (8 AWG) fios flexíveis  
1,5 mm<sup>2</sup> (16 AWG) fios rígidos



L mm	mm <sup>2</sup>	mm	€	U	U
190	4÷16	2-5	168,00	1	011480200

## 1148B/R

lâminas de substituição para artigo 1148B



1148B/R	€ 76,50	U 1	U 011480202
---------	---------	-----	-------------

## 1149F

alicate frontal de descarnar fio com lâmina de corte, com fecho automático



L mm	mm <sup>2</sup>	€	U	U
175	0,2 ÷ 6	15,30	1	011490010

## 1150

alicates universais em cromado brilhante com punhos de dupla camada de PVC



ISO 5746

L mm	L1 mm	mm	€	U	U
160	37	1,6	19,60	5	011500006
180	41	1,8	21,30	5	011500008
200	45	2,0	23,50	5	011500010
220	50	2,0	25,50	2	011500012

# Beta

## 1150BM

alicates universais em cromado brilhante com punhos bi-material



ISO 5746

L mm	L1 mm	mm	€	U	U
160	37	1,6	24,60	3	011500036
180	41	1,8	27,00	3	011500038
200	45	2,0	30,00	3	011500040
220	50	2,0	32,50	2	011500042

## 1153

alicates reguláveis com duas posições e punhos em PVC



UNI ISO 9343

L mm	L1 mm	€	U	U
200	34	22,40	2	011530120

## 1162

alicates de pontas chatas extra-longas com estrias e punhos de dupla camada em PVC



ISO 5745

L mm	L1 mm	mm	€	U	U
160	58	1,6	22,90	5	011620006
200	86	1,6	26,00	5	011620010

## 1162BM

alicates de pontas chatas extra-longas com estrias punhos bi-material



ISO 5745

L mm	L1 mm	mm	€	U	U
160	58	1,6	28,00	3	011620036
200	86	1,6	32,50	3	011620040

## 1164

alicates de pontas curvas chatas com estrias, extra-longas, e punhos de dupla camada de PVC



ISO 5745

L	L1	$\frac{1}{2}$	€		
mm	mm	mm			
160	54	1,6	25,00	5	011640006
200	76	1,6	28,00	5	011640010

## 1164BM

alicates de pontas curvas chatas com estrias, extra-longas, e punhos de dupla camada de PVC



ISO 5745

L	L1	$\frac{1}{2}$	€		
mm	mm	mm			
160	54	1,6	31,50	3	011640036
200	76	1,6	35,00	3	011640040

## 1166

alicates de pontas semi-redondas com estrias, extra-longas, e punhos de dupla camada de PVC



ISO 5745

L	L1	$\frac{1}{2}$	€		
mm	mm	mm			
160	56	1,6	22,90	5	011660006
200	76	1,6	26,00	5	011660010

## 1166BM

alicates de pontas semi-redondas com estrias, extra-longas, e punhos bi-material



ISO 5745

L	L1	$\frac{1}{2}$	€		
mm	mm	mm			
160	56	1,6	28,00	3	011660036
200	76	1,6	32,50	3	011660040

## 1168

alicates de pontas curvas semi-redondas com estrias, extra-longas, e punhos de dupla camada de PVC



ISO 5745

L	L1	$\frac{1}{2}$	€		
mm	mm	mm			
160	54	1,6	25,00	5	011680006
200	76	1,6	28,00	5	011680010

## 1168BM

alicates de pontas curvas semi-redondas com estrias, extra-longas, e punhos bi-material



ISO 5745

L	L1	$\frac{1}{2}$	€		
mm	mm	mm			
160	54	1,6	31,50	3	011680036
200	70	1,6	35,00	3	011680040

## 1171BM

alicate de pontas chatas curtas, brunido punhos bi-material



ISO 9655

L	L1	A	B	€		
mm	mm	mm	mm			
125	18	12	8	39,00	2	011710101

## 1172BM

alicate de pontas chatas longas, brunido punhos bi-material

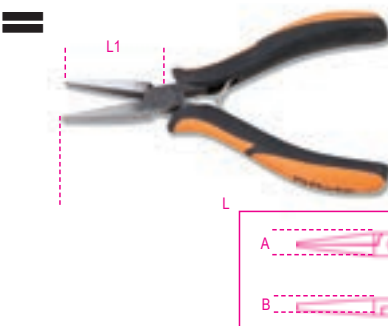

ISO 9655

L	L1	A	B	€		
mm	mm	mm	mm			
140	40	12	8	39,00	2	011720101

## 1172BM/P

alicate de pontas chatas curvas, brunido punhos bi-material

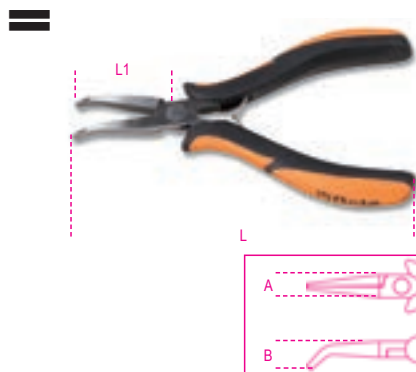

L	L1	A	B	€		
mm	mm	mm	mm			
140	38	12	13	44,00	2	011720102

## 1173BM

alicate de pontas redondas curtas, punhos bi-material

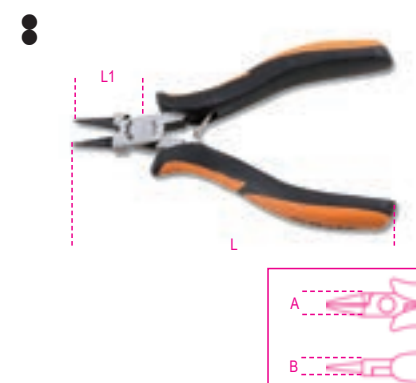

ISO 9655

L	L1	A	B	€		
mm	mm	mm	mm			
125	22	12	8	39,00	2	011730101

## 1175BM

alicate de pontas semi-redondas curtas, brunido punhos bi-material

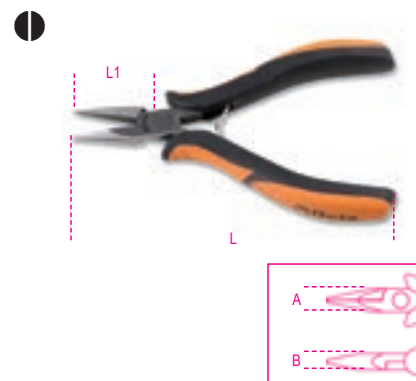

ISO 9655

L	L1	A	B	€		
mm	mm	mm	mm			
140	29	12	8	39,00	2	011750101

### 1177BM

alicate de pontas semi-redondas longas,  
brunido  
punhos bi-material

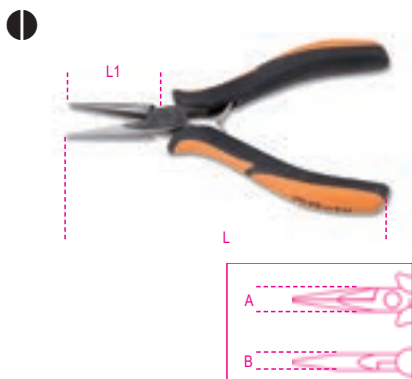

ISO 9655

L	L1	A	B	€	2	011770101
140	38	12	8	39,00		

### 1177BM/Z

alicate de pontas semi-redondas longas  
com estrias  
punhos bi-material



ISO 9655

L	L1	A	B	€	2	011770113
140	39	12	8	44,00		

### 1178BM

alicate de pontas semi redondas longas,  
brunido  
punhos bi-material

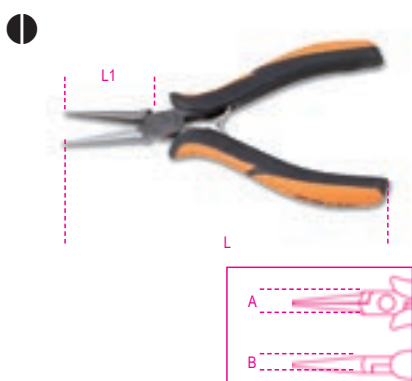

ISO 9655

L	L1	A	B	€	2	011780101
140	37	12	8	44,00		

### 1178BM/P

alicate de pontas semi-redondas longas  
curvas, brunido  
punhos bi-material

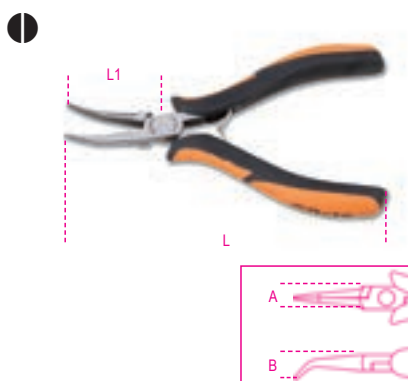

L	L1	A	B	€	2	011780102
140	36,5	12	12	44,00		

**Alicate de corte diagonal, semi-raso pontas  
finas, punhos bi-material**  
Para trabalhos mais fortes, ver item 1081

### 1182BM

alicate de corte diagonal, semi-raso  
pontas finas  
punhos bi-material



ISO 9654

L	L1	A	Cu	€	2	011820101
120	11	10	1	44,00		

### 1183BM

alicate de corte diagonal, semi-raso  
pontas redondas  
punhos bi-material



ISO 9654

L	L1	A	Cu	€	2	011830101
120	11	10	1	44,00		

### 1184BM

alicate de corte diagonal, raso  
pontas redondas  
punhos bi-material



ISO 9654

L	L1	A	Cu	€	2	011840101
120	11	10	1	45,00		
130	13	12,5	1,25	45,00		2 011840102

### 1185BM

alicate de corte diagonal, raso  
pontas finas  
punhos bi-material



ISO 9654

L	L1	A	Cu	€	2	011850101
120	11	10	1	44,00		
130	13	12,5	1,25	44,00		2 011850102



## 1186BM

alicate de corte diagonal, raso,  
pontas finas e estriadas  
punhos bi-material



ISO 9654

L	L1	A	Cu	€	🔧	📦
mm	mm	mm	mm			
120	11	10	1	44,00	2	011860101
130	13	12,5	1,25	47,00	2	011860102

## 1188BM

alicate de corte diagonal normal  
punhos bi-material



ISO 9654

L	L1	A	Cu	€	🔧	📦
mm	mm	mm	mm			
125	12	12	1,25	44,00	2	011880101
130	17	15	2	44,00	2	011880102

## 1190BM

alicate de corte frontal, semi raso  
punhos bi-material



ISO 9654

L	L1	A	Cu	€	🔧	📦
mm	mm	mm	mm			
120	12	12	1,25	44,00	2	011900113

## 1191BM

alicate de corte frontal oblíquo, raso  
punhos bi-material



ISO 9654

L	L1	A	Cu	€	🔧	📦
mm	mm	mm	mm			
130	8	12	0,8	44,00	2	011910101

## 1191BM/L

alicate de corte frontal oblíquo longo, raso  
punhos bi-material



ISO 9654

L	L1	A	Cu	€	🔧	📦
mm	mm	mm	mm			
130	18	12	1	45,00	2	011910110

## 1191R/5-M

kit de molas de substituição para alicates e  
pinças  
para componentes eletrônicos, 5 pares  
(artigos: 1171...1191)

Artigo	€	🔧	📦
1191R/5-M	8,20	1	011910995

## 1200MS

magnetizador/desmagnetizador

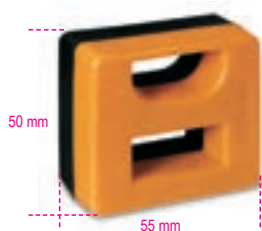

Artigo	€	🔧	📦
1200MS	14,20	5	012000000

## 1201

chaves para parafusos  
de perfil de fenda



ISO 2380

SxAxL	L1	Ø	€	🔧	📦
mm	mm	mm			
0,4x2,5x50	146	2,5	3,40	5	012010003
0,4x2,5x75	166	2,5	3,50	5	012010006
0,5x3x75	171	3,0	3,60	5	012010009
0,5x3x100	196	3,0	3,90	5	012010012
0,6x3,5x75	171	3,5	3,95	5	012010018
0,6x3,5x100	196	3,5	4,00	5	012010021
0,8x4x100	196	4,0	4,05	5	012010030
0,8x4x125	221	4,0	4,30	5	012010033
0,8x4x150	246	4,0	4,65	5	012010036
1,0x5,5x100	209	5,0	5,00	5	012010039
1,0x5,5x125	234	5,0	5,20	5	012010040
1,0x5,5x150	259	5,0	5,40	5	012010042
1,2x6,5x100	220	6,0	5,85	5	012010048
1,2x6,5x125	234	6,0	6,05	5	012010050
1,2x6,5x150	270	6,0	6,20	5	012010051
1,2x8x150	282	8,0	8,10	3	012010057
1,2x8x200	332	8,0	8,65	3	012010060
1,6x10x200	332	9,5	9,95	3	012010066



Artigo	€	🔧	📦
1201/S6	34,50	1	012010206

0,5x3x75-0,6x3,5x100  
0,8x4x100-1,0x5,5x100  
1,2x8x150-1,6x10x200 mm

## 1201N

chave de perfil de fenda de série extra curta



ISO 2380

SxAxL	L1	Ø	€	🔧	📦
mm	mm	mm			
0,8x4x30	86,5	4	4,80	3	012010103
1,2x6,5x30	86,5	6	5,10	3	012010106

## 1201DZ

chaves para parafusos de perfil Dzus®



Artigo	€	🔧	📦
1201DZ	12,00	2	012010501



## 1202

chaves para parafusos de perfil Phillips®



UNI/ISO 8764

PHxDxL mm	L1 mm	€	🔧	📦
0x3x60	156	3,50	5	012020003
0x3x100	200	3,95	5	012020006
1x4,5x80	189	4,60	5	012020009
1x4,5x120	229	5,00	5	012020012
2x6x100	220	6,15	5	012020018
2x6x150	270	6,65	5	012020021
3x8x150	282	8,30	3	012020024
4x9,5x200	332	11,30	3	012020027



	€	🔧	📦
1202/S4 PH0x3x60-PH1x4,5x120 PH2x6x150-PH3x8x150 mm	23,50	1	012020204

## 1202N

chave de perfil Phillips(R) de série extra curta



UNI/ISO 8764

PHxDxL mm	L1 mm	€	🔧	📦
1x4,5x30	86,5	4,80	3	012020103
2x6x30	86,5	5,15	3	012020106

## 1202L

chaves de parafusos para perfil Phillips®, série longa



UNI/ISO 8764-1

PHxDxL mm	L1 mm	€	🔧	📦
0x3x300	400	6,25	3	012020303
1x4,5x300	400	6,80	3	012020305
1x4,5x400	508	8,30	3	012020306
2x6x400	519	9,60	3	012020309

## 1203/D

jogo de chaves de parafusos



	€	🔧	📦
1203/D5	26,50	1	012030001

1201	0,6x3,5x100-1,0x5,5x150 1,2x6,5x150 mm
1202	PH1x4,5x80-PH2x6x100 mm

	€	🔧	📦
1203/D7	33,00	1	012030007

1201	0,5x3x75-0,8x4x100 1,0x5,5x100-1,2x6,5x150 mm
1202	PH0x3x60-PH1x4,5x80 PH2x6x100 mm

	€	🔧	📦
1203/D8	42,00	1	012030008

1201	0,5x3x75-0,8x4x125 1,0x5,5x150-1,2x6,5x150 mm
1202	PH0x3x60-PH1x4,5x80 PH2x6x100-PH3x8x150 mm

	€	🔧	📦
1203/D10N	46,50	1	012030019

1201	0,4x2,5x50-0,5x3x75-0,8x4x100- 1,0x5,5x150-1,2x6,5x150 mm
1201N	0,8x4x30 mm
1202	PH0x3x60-PH1x4,5x80- PH2x6x100 mm
1202N	PH1x4,5x30 mm

	€	🔧	📦
1203/D10	53,00	1	012030010

1201	0,4x2,5x50-0,5x3x75 0,8x4x100-1,0x5,5x100 1,2x6,5x150-1,2x8x150 mm
1202	PH0x3x60-PH1x4,5x80 PH2x6x100-PH3x8x150 mm

	€	🔧	📦
1203/D6	27,00	1	012030006

1202	PH1x4,5x80-PH2x6x100 mm
1204	0,4x2,5x60-0,5x3x100 0,8x4x100-1,0x5x125 mm

	€	🔧	📦
1203/D5PZ	26,00	1	012030003

1201	0,5x3x75-0,8x4x125 1,0x5,5x150 mm
1209PZ	PZ1x4,5x80-PZ2x6x100 mm

## 1203/S



	€	🔧	📦
1203/S8	37,00	1	012030009

1201	2,5x50-3x75-4x100-5,5x125- 6,5x150 mm
1202	PH0x3x60-PH1x4,5x80- PH2x6x100 mm



	€	🔧	📦
1203/S10	53,50	1	012030021

1201	0,4x2,5x50-0,5x3x75 0,8x4x125-1,0x5,5x150 1,2x6,5x150-1,2x8x150 mm
1202	PH0x3x60-PH1x4,5x80 PH2x6x100-PH3x8x150 mm



## 1204

chaves para parafusos de perfil de fenda sem cabeça



SxDxL mm	L1 mm	€	🔧	📦
0,4x2,5x60	156	3,45	5	012040003
0,6x3x75	175	3,55	5	012040006
0,5x3x100	196	3,60	5	012040009
0,8x4x100	196	4,05	5	012040012
0,8x4x125	233	4,40	5	012040015
1x5x125	234	4,95	5	012040018
1x5x150	258	5,45	5	012040021
1,2x6,5x150	270	5,90	5	012040024



	€	🔧	📦
1204/S5 0,4x2,5x60-0,5x3x100 0,8x4x100-1x5x125 1,2x6,5x150 mm	22,00	1	012040205

## 1204L

chaves para parafusos de perfil de fenda sem cabeça, série longa



SxL mm	L1 mm	€	🔧	📦
0,5x2,5x200	300	5,05	3	012040303
0,5x3x300	400	6,00	3	012040306
0,8x4x400	508	7,55	3	012040309
1x5x400	508	8,10	3	012040315
1,2x6,5x400	519	10,20	3	012040318

## 1205ES

chaves sextavadas com punho



mm	L mm	L1 mm	€	🔧	📦
1,5	100	200	4,40	3	012050315
2	100	200	4,55	3	012050320
2,5	100	200	4,60	3	012050325
3	100	200	4,70	3	012050330
4	100	208	5,25	3	012050340
5	100	219	6,45	3	012050350
6	125	244	6,55	3	012050360
8	150	277	8,85	2	012050380

## 1207TX

chaves para parafusos de perfil Torx®



	L mm	L1 mm	Ø mm	€	🔧	📦
T5	50	150	3	5,15	5	012070005
T6	60	156	4	5,85	5	012070006
T7	60	156	4	5,90	5	012070007
T8	60	156	4	6,00	5	012070008
T9	60	156	4	6,25	5	012070009
T10	80	189	5	6,80	5	012070010
T15	80	189	5	6,90	5	012070015
T20	100	209	5	7,00	5	012070020
T25	100	209	5	7,20	5	012070025
T27	100	220	6	7,55	5	012070027
T30	100	220	6	7,85	5	012070030
T40	130	262	7	9,05	2	012070040
T45	130	262	8	10,10	2	012070045



1207TX/D7  
T6-T8-T10-T15  
T20-T25-T30

€ 47,50 1 012070207

## 1208RTX

chaves para parafusos de perfil Tamper Resistant Torx®



Ø	L mm	L1 mm	Ø mm	€	🔧	📦
T9	60	156	4	6,35	5	012080009
T10	80	189	5	7,00	5	012080010
T15	80	189	5	7,35	5	012080015
T20	100	209	5	7,45	5	012080020
T25	100	209	5	7,55	5	012080025
T27	100	220	6	8,20	5	012080027
T30	100	220	6	8,55	5	012080030
T40	130	262	7	10,10	2	012080040



1208RTX/D7  
T9-T10-T15-T20  
T25-T27-T30

€ 52,50 1 012080207

## 1209PZ

chaves de punho para parafusos de perfil Pozidriv® - Supadriv®



UNI/ISO 8764

PZ	L mm	L1 mm	€	🔧	📦
0	60	156	4,30	5	012090000
1	80	189	5,45	5	012090003
2	100	220	7,10	5	012090006
3	150	282	10,70	3	012090009
4	200	327	11,80	3	012090012



1209PZ/S4  
PZ0-PZ1-PZ2-PZ3

€ 27,50 1 012090204

## 1209N/PZ

chaves com punho para parafusos de perfil Pozidriv®-Supadriv®, série extra-curta



PZ	L mm	L1 mm	€	🔧	📦
1	30	87	4,90	3	012090103
2	30	87	5,10	3	012090106



## 1229LP

chaves de relógio para parafusos de perfil de fenda sem cabeça

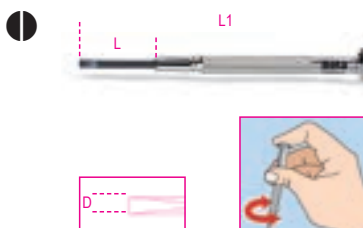

D mm	L mm	L1 mm	€	🔧	📦
1,0	17	75	3,75	5	012290210
1,2	21	85	3,75	5	012290212
1,4	21	89	3,75	5	012290214
1,8	23	94	3,75	5	012290218
2,0	23	98	3,75	5	012290220
2,4	26	103	3,75	5	012290224
3,0	28	108	4,50	5	012290230



1229LP/A6  
1,2-1,4-1,8-2-2,4-3 mm

€ 22,40 1 012290300

## 1229PH

chaves de relógio para parafusos de perfil Phillips®

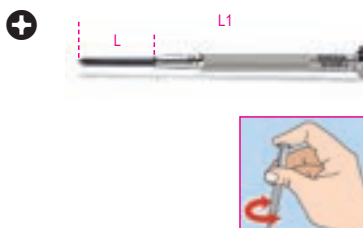

PH	L mm	L1 mm	€	🔧	📦
0	26	102	4,15	5	012290250
1	29	107	4,40	5	012290251

## 1229LPH/A6

jogo de 6 chaves de relógio 1229LP-1229PH



1229LPH/A6  
1229LP 1,4-2,0-2,4-3 mm  
1229PH PH0-PH1

€ 22,40 1 012290310

## 1236B

chave de parafusos angular para parafusos de perfil de fenda

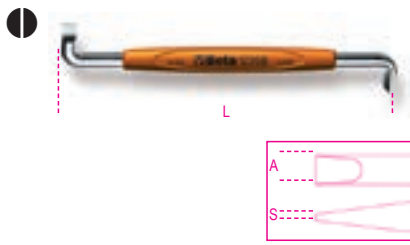

UNI 7079 DIN 5200

SxA mm	L mm	€	🔧	📦
0,8x4	100	6,35	5	012360201
1x5,5	125	7,45	5	012360202
1,2x8	150	9,20	5	012360204

## 1238B

chave de parafusos angular para parafusos de perfil Phillips®



UNI 7083 DIN 5208

PH	L mm	€	🔧	📦
1-2	125	7,45	5	012380201
3-4	200	12,50	5	012380203

## 1241

chave de parafusos com ponta de aço para parafusos de perfil de fenda



SxAxL mm	L1 mm	€	🔧	📦
1x5,5x100	202	9,75	5	012410039
1,2x6,5x125	240	10,90	5	012410050
1,2x8x150	268	13,30	3	012410057
1,6x10x200	325	16,90	2	012410066

## 1242

chave de parafusos com ponta de aço para parafusos com perfil Phillips®

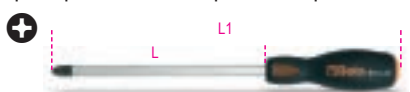

UNI/ISO 8764

PHxDxL mm	L1 mm	€	🔧	📦
1x4,5x100	202	9,60	5	012420209
2x6x100	215	11,40	5	012420218
3x8x150	268	14,80	3	012420221
4x11x200	325	19,10	2	012420224

## 1243/D7

Jogo de 7 chaves de parafusos com ponta de aço



1243/D7 € 87,00 1 012430017

1241	1x5,5x100-1,2x6,5x125
1242	1,2x8x150-1,6x10x200 mm PH1x4,5x100-PH2x6x100 PH3x8x150 mm

## 1250

chaves de fenda com guia prensili



SxDxL mm	L1 mm	€	🔧	📦
0,5x3x125	190	14,20	5	012500030
0,6x4x125	225	15,30	5	012500040
0,7x5x150	255	18,00	5	012500050

## 1251

chaves para parafusos de perfil Phillips® com guia prensili



PHxDxL mm	L1 mm	€	🔧	📦
0x4x125	225	15,90	5	012510000
1x5x150	255	18,70	5	012510010
2x6x175	280	21,50	5	012510020

## 1252/S5



1252/S5 € 88,00 1 012520001

1250	0,5x3x125-0,6x4x125 0,7x5x150 mm
1251	PH1x5x150-PH2x6x175 mm

## 1253

busca-pólos 150/250V

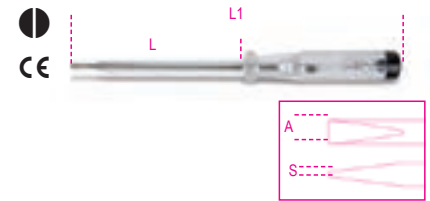

SxAxL mm	L1 mm	€	🔧	📦
0,5x3,5x100	190	8,30	5	012530001

## 1253A

busca-pólos 125/250V, duplo isolamento

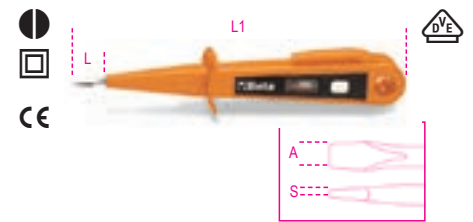

SxAxL mm	L1 mm	€	🔧	📦
0,5x3x15	150	6,00	5	012530010

## 1254

busca-pólos 6/24V

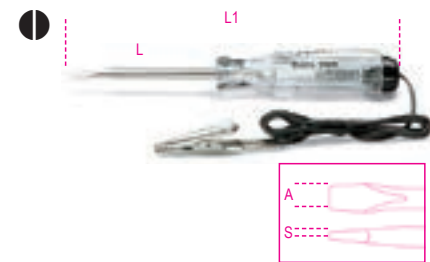

SxAxL mm	L1 mm	€	🔧	📦
0,5x3x44	123	8,95	5	012540001

## 1256/C36-2

punho para micro-chaves com 36 pontas intermutáveis de 4 mm e extensão magnética



1256/C36-2	€	🔧	📦
	60,00	1	012560100

1256TX	T3 - T4 - T5 - T6 - T7 T8 - T9 - T10 - T15
1256RTX	T6 - T7 - T8 - T9 - T10
1256LP	0,8 - 1,2 - 1,5 - 1,8 - 2 - 2,5 3 - 3,5 - 4 mm
1256PE	0,7 - 0,9 - 1,3 - 1,5 - 2 mm
1256PH	PH000 - PH00 - PH0 - PH1
1256PZ	PZ000 - PZ00 - PZ0 - PZ1
1256/20	
1256/30	

130x60x35 mm - 200 g

## 1256LP

bits 4 mm  
para parafusos ranhurados

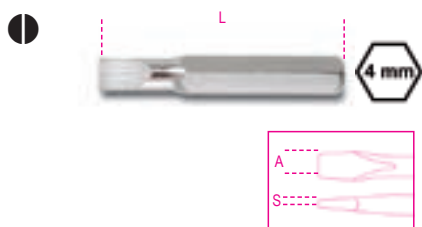

SxA mm	L mm	€	5	10
0.25x0.8	27	1,15	5	012560001
0.25x1.2	27	1,15	5	012560002
0.3x1.5	27	1,15	5	012560003
0.35x1.8	27	1,15	5	012560004
0.4x2.0	27	1,15	5	012560005
0.4x2.5	27	1,15	5	012560006
0.5x3.0	27	1,15	5	012560007
0.6x3.5	27	1,15	5	012560008
0.8x4.0	27	1,15	5	012560009

## 1256PH

bits 4 mm  
para parafusos Phillips®



PH	L mm	€	5	10
000	27	1,15	5	012560011
00	27	1,15	5	012560012
0	27	1,15	5	012560013
1	27	1,15	5	012560014

## 1256PZ

bits 4 mm  
para parafusos de cabeça ranhurada Pozidriv®  
- Supradriv®



PZ	L mm	€	5	10
000	27	1,15	5	012560061
00	27	1,15	5	012560062
0	27	1,15	5	012560063
1	27	1,15	5	012560064

## 1256PE

bits 4 mm  
para parafusos sextavados



mm	L mm	€	5	10
0.7	27	1,15	5	012560021
0.9	27	1,15	5	012560022
1.3	27	1,15	5	012560023
1.5	27	1,15	5	012560024
2.0	27	1,15	5	012560025

## 1256TX

bits 4 mm  
para parafusos Torx®



T	L mm	€	5	10
T3	27	1,20	5	012560041
T4	27	1,20	5	012560042
T5	27	1,20	5	012560043
T6	27	1,20	5	012560044
T7	27	1,20	5	012560045
T8	27	1,20	5	012560046
T9	27	1,20	5	012560047
T10	27	1,20	5	012560048
T15	27	1,20	5	012560049

## 1256RTX

bits 4 mm  
para parafusos invioláveis "Tamper Resistant  
Torx®"



T	L mm	€	5	10
T6	27	1,45	5	012560051
T7	27	1,45	5	012560052
T8	27	1,45	5	012560053
T9	27	1,45	5	012560054
T10	27	1,45	5	012560055

## 1256/20

extensão sextavada, 4 mm



1256/20	€	5	10
	7,10	5	012560092

## 1256/30

porta-bits 4 mm com punho



L mm	€	5	10
110	8,65	2	012560097

## 1257LP

micro-chaves para parafusos  
de perfil de fenda



SxD mm	L mm	€	5	10
0,2x1,2	60	4,65	5	012570012
0,25x1,5	60	4,65	5	012570015
0,3x1,8	60	4,65	5	012570018
0,4x2	60	4,65	5	012570020
0,4x2,5	60	4,65	5	012570024
0,5x3	60	4,65	5	012570030
0,6x3,5	60	4,65	5	012570035
0,8x4	60	4,65	5	012570040



1257LP/S8	€	5	10
	59,00	1	012570200

0,2x1,2-0,25x1,5  
0,3x1,8-0,4x2-0,4x2,5  
0,5x3-0,6x3,5-0,8x4 mm

## 1257PH

micro-chaves para parafusos  
de perfil Phillips®



PH	L mm	€	5	10
00	60	4,65	5	012570060
0	60	4,65	5	012570063
1	60	4,65	5	012570066

## 1257LPH/S8

Jogo de 8 micro-chaves (refa.  
1257LP, 1257PH) em caixa



1257LPH/S8	€	5	10
	59,00	1	012570210

1257PH PH00-PH0-PH1  
1257LP 0,4x2-0,4x2,5-0,5x3  
0,6x3,5-0,8x4 mm

## 1257ES

micro-chaves com ponta  
macho hexagonal



mm	L mm	€	5	10
0,9	60	5,05	5	012570045
1,3	60	5,05	5	012570046
1,5	60	5,05	5	012570047
2	60	5,05	5	012570048
2,5	60	5,05	5	012570049
3	60	5,05	5	012570050

## 1257ESB/S8



<b>1257ESB/S8</b>	€ 65,50	1	012570230
1257ES	0,9-1,3-1,5-2-2,5-3 mm		
1257BE	4-5 mm		

## 1257TX

micro-chaves para parafusos de perfil Torx®



Ø	L mm	€	U	U
T5	60	5,35	5	012570075
T6	60	5,35	5	012570076
T7	60	5,35	5	012570077
T8	60	5,35	5	012570078
T9	60	5,35	5	012570079
T10	60	5,35	5	012570080
T15	60	5,35	5	012570081
T20	60	5,35	5	012570082



<b>1257TX/S8</b>	€ 64,50	1	012570220
T5-T6-T7-T8			
T9-T10-T15-T20			

## 1257BE

micro-chave de fenda para parafusos macho sextavados



Ø mm	L mm	€	U	U
3,2	60	6,80	5	012570085
4	60	6,80	5	012570086
5	60	6,80	5	012570087
5,5	60	6,80	5	012570088

## 1260

chaves para parafusos de perfil de fenda

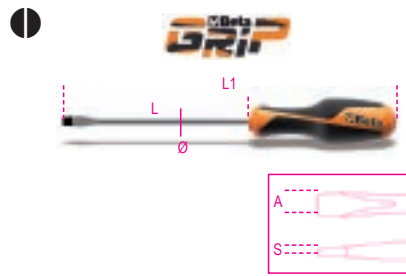

ISO 2380

SxAxL mm	L1 mm	Ø mm	€	U	U
0,4x2,5x50	150	2,5	4,80	5	012600003
0,4x2,5x75	175	2,5	4,95	5	012600006
0,5x3x75	175	3,0	5,05	5	012600009
0,5x3x100	200	3,0	5,25	5	012600012
0,6x3,5x75	175	3,5	5,40	5	012600018
0,6x3,5x100	200	3,5	5,45	5	012600021
0,8x4x100	208	4,0	5,90	5	012600030
0,8x4x125	233	4,0	6,15	5	012600033
0,8x4x150	258	4,0	6,35	5	012600036
1x5,5x100	208	5,0	6,80	5	012600039
1x5,5x125	233	5,0	6,90	5	012600040
1x5,5x150	258	5,0	7,55	5	012600042
1,2x6,5x100	219	6,0	8,20	5	012600048
1,2x6,5x125	244	6,0	8,40	5	012600050
1,2x6,5x150	269	6,0	8,75	5	012600051
1,2x8x150	277	8,0	10,80	3	012600057
1,2x8x200	327	8,0	11,30	3	012600060
1,6x10x200	327	9,5	13,60	3	012600066
2x12x250	377	10	16,00	3	012600069
2x14x250	377	10	16,90	2	012600073



<b>1260/S6</b>	€ 44,00	1	012600306
0,4x2,5x75-0,5x3x75-0,8x4x125			
1x5,5x150-1,2x6,5x150-1,2x8x200 mm			

## 1260N

chaves para parafusos de perfil de fenda, série extra curta



ISO 2380

SxAxL mm	L1 mm	Ø mm	€	U	U
0,8x4x30	87	4	6,35	5	012600103
1,2x6,5x30	87	6	6,80	5	012600106



## 1260E

chaves para parafusos de perfil de fenda com sextavado auxiliar



ISO 2380

SxAxL mm	L1 mm	Ø mm	€	U	U
1,2x6,5x150	269	6,0	11,50	3	012600156
1,2x8x175	301	8,0	14,20	3	012600157
1,6x10x200	327	9,5	16,70	2	012600159
2x12x250	377	9,5	19,10	2	012600162

## 1262

chaves para parafusos de perfil Phillips(R)



UNI/ISO 8764

PhxDxL mm	L1 mm	€	U	U
0x3x60	160	5,05	5	012620003
0x3x100	200	5,40	5	012620006
1x4,5x80	188	6,65	5	012620009
1x4,5x120	228	7,20	5	012620012
2x6x100	219	8,20	5	012620018
2x6x150	269	8,95	5	012620021
3x8x150	277	12,10	3	012620024
4x10x200	327	15,30	3	012620027



<b>1262/S4</b>	€ 32,50	1	012620304
PH0x3x60-PH1x4,5x80			
PH2x6x100-PH3x8x150 mm			

## 1262N

chaves para parafusos de perfil Phillips®, série extra curta



UNI/ISO 8764

PhxDxL mm	L1 mm	€	U	U
1x4,5x30	87	6,35	5	012620103
2x6x30	87	6,90	5	012620106

## 1262E

chaves para parafusos de perfil Phillips® com sextavado auxiliar



UNI/ISO 8764

PHxDxL mm	L1 mm	€	🔧	📦
2x6x150	269	11,50	3	012620153
3x8x175	302	14,20	3	012620156
4x10x200	327	16,80	2	012620159

## 1262L

chaves para parafusos de perfil Phillips®, série longa



UNI/ISO 8764-1

PHxDxL mm	L1 mm	€	🔧	📦
0x3x300	400	8,95	3	012620203
1x4,5x300	400	10,40	3	012620205
1x4,5x400	508	12,30	3	012620206
2x6x400	519	15,90	3	012620209

## 1263/D...

jogo de chaves de parafusos



🔧	📦	€
1263/D6	1	41,50

1260	PH1x4,5x80 PH2x6x100 mm
1264	0,5x2,5x60-0,6x3x100 0,8x4x125-1x5x125 mm

🔧	📦	€
1263/D7	1	43,50

1260	PH1x4,5x80 PH2x6x100 mm
1264	0,5x2,5x60-0,6x3x100 0,8x4x125-1x5x125 mm

🔧	📦	€
1263/D7PZ	1	49,50

1260	0,5x3x75-0,8x4x100 1x5,5x150-1,2x6,5x150 mm
1269PZ	PZ0 - PZ1 - PZ2

🔧	📦	€
1263/D8	1	51,50

1260	0,4x2,5x50-0,5x3x75 0,8x4x100-1x5,5x125 1,2x6,5x150 mm
1262	PH0x3x60-PH1x4,5x80 PH2x6x100 mm

🔧	📦	€
1263/D10	1	65,50

1260	0,5x3x75-0,6x3,5x100 0,8x4x125-1x5,5x150 1,2x6,5x150 mm
1260N	0,8x4x30
1262	PH0x3x60-PH1x4,5x80 PH2x6x100 mm
1262N	PH1x4,5x30

## 1263/S12

jogo de 12 chaves de parafusos



🔧	📦	€
1263/S12	1	94,00

1260	0,4x2,5x50-0,5x3x75 0,6x3,5x100-0,8x4x125 1x5,5x125-1,2x6,5x150 1,2x8x200-1,6x10x200 mm
1262	PH0x3x60-PH1x4,5x80 PH2x6x100-PH3x8x150 mm

## 1264

jogo de chaves para parafusos de perfil de fenda sem cabeça



SxDxL mm	L1 mm	€	🔧	📦
0,5x2,5x60	160	4,90	5	012640003
0,6x3x75	175	5,15	5	012640006
0,6x3x100	200	5,25	5	012640009
0,8x4x100	208	6,15	5	012640012
0,8x4x125	233	6,25	5	012640015
1x5x125	233	6,90	5	012640018
1x5x150	258	7,55	5	012640021
1,2x6,5x150	269	8,85	5	012640024



🔧	📦	€
1264/S5	1	32,00

0,5x2,5x60-0,6x3x75 0,8x4x100-1x5x125-1,2x6,5x150 mm
---

## 1264L

jogo de chaves para parafusos de perfil de fenda sem cabeça, série longa



SxDxL mm	L1 mm	€	🔧	📦
0,5x2,5x200	300	7,20	3	012640203
0,6x3x300	400	8,30	3	012640206
0,8x4x400	508	10,90	3	012640209
1x5x400	508	12,30	3	012640215
1,2x6,5x400	519	14,80	3	012640218

## 1265ES

chaves hexagonais com punhos



mm	L mm	L1 mm	€	🔧	📦
1,5	100	200	5,80	3	012650015
2	100	200	6,00	3	012650020
2,5	100	200	6,25	3	012650025
3	100	200	6,55	3	012650030
4	100	208	7,20	3	012650040
5	100	219	8,40	3	012650050
6	125	244	9,50	3	012650060
8	150	277	12,40	2	012650080



🔧	📦	€
1265ES/S8	1	62,50

1,5-2-2,5-3-4-5-6-8 mm

## 1266BP

chaves hexagonais de extremidade esférica com punhos



mm	L mm	L1 mm	€	🔧	📦
2	100	200	6,45	3	012660020
2,5	100	200	6,65	3	012660025
3	125	225	7,00	3	012660030
4	125	233	7,75	3	012660040
5	120	239	8,95	3	012660050
6	140	259	10,30	3	012660060
8	160	287	13,00	2	012660080
10	160	287	15,30	2	012660100



**1266BP/S8** € 75,50 1 012660308  
2-2,5-3-4-5-6-8-10 mm

### 1267TX

chaves para parafusos de perfil Torx®, com punhos



Ø	L mm	L1 mm	Ø mm	€	U	012670005
T5	50	150	3	7,20	5	012670005
T6	50	150	3	7,55	5	012670006
T7	50	150	3	7,75	5	012670007
T8	60	160	3	8,10	5	012670008
T9	60	167	4	8,55	5	012670009
T10	80	188	4	8,85	5	012670010
T15	80	188	4	9,40	5	012670015
T20	100	208	4,5	9,85	5	012670020
T25	100	208	5	10,50	5	012670025
T27	115	234	6	11,10	5	012670027
T30	115	234	6	11,40	5	012670030
T40	130	257	7	13,00	2	012670040
T45	130	257	8	14,20	2	012670045



**1267TX/D7** € 65,50 1 012670307  
T6-T8-T10-T15  
T20-T25-T30



**1267TX/S13** € 127,00 1 012670312  
T5-T6-T7-T8-T9  
T10-T15-T20-T25  
T27-T30-T40-T45

### 1268RTX

chaves para parafusos de perfil Tamper Resistant Torx®, com punhos



Ø	L mm	L1 mm	Ø mm	€	U	012680009
T9	60	167	4,0	9,20	3	012680009
T10	80	188	4,0	9,50	3	012680010
T15	80	188	4,0	9,85	3	012680015
T20	100	208	4,5	10,50	3	012680020
T25	100	208	5,0	10,80	3	012680025
T27	115	234	6,0	11,60	3	012680027
T30	115	234	6,0	11,90	3	012680030
T40	130	257	7,0	13,50	2	012680040



**1268RTX/S8** € 87,00 1 012680307  
T9-T10-T15-T20  
T25-T27-T30-T40

### 1269PZ

chaves para parafusos de perfil Pozidriv®-Supadriv®



UNI/ISO 8764

PZ	L mm	L1 mm	€	U	012690000
0	60	160	5,70	5	012690000
1	80	188	7,45	5	012690001
2	100	219	9,05	5	012690002
3	150	277	12,90	3	012690003
4	200	327	16,60	3	012690004



**1269PZ/S4** € 35,00 1 012690304  
PZ0-PZ1-PZ2-PZ3

### 1269N/PZ

chaves para parafusos de perfil Pozidriv®-Supadriv®, série extra curta



UNI/ISO 8764

PZ	L mm	L1 mm	€	U	012690011
1	30	87	6,35	5	012690011
2	30	87	6,90	5	012690012

### 1281BG

punho para chave de parafusos de lâmina intermutável



L mm 118, € 10,70 5 012810280

### 1281PM

porta-pontas magnético de fixação rápida



L mm 165, € 18,60 5 012810292

### 1281PB

porta-chaves de caixa com quadra macho 1/4"



L mm 175, € 14,70 5 012810293

### 1281LP

lâmina reversível intermutável para parafusos de perfil de fenda



**1281LP/1** € 9,40 5 012810302  
0,8x4-1,2x6,5 mm  
**1281LP/2** € 9,40 5 012810304  
1x5,5-1,2x6,5 mm

## 1281PH

lâmina reversível intermutável para parafusos de perfil Phillips®



PH	€	5	012810310
1-2	9,40		
2-3	9,40		012810312

## 1281LPH

lâmina reversível intermutável para parafusos de perfil Phillips® e fenda



	€	5	012810321
1281LPH/1 PH0-0,8x4 mm	9,40		
1281LPH/2 PH1-1x5,5 mm	9,40		012810322
1281LPH/3 PH2-1,2x6,5 mm	9,40		012810323

## 1281PZ

lâmina reversível intermutável para parafusos de perfil Pozidriv®-Supadriv®



PZ	€	5	012810330
1-2	9,40		
2-3	9,40		012810332

## 1281PE

lâmina reversível intermutável hexagonal macho, esférica



mm	€	5	012810342
2,5	9,30		
3	9,30		012810343
4	9,30		012810344
5	9,30		012810345
6	9,30		012810346

## 1281TX

lâmina reversível intermutável para parafusos de perfil Torx®



	€	5	012810349
1281TX/1 T6-T8	10,10		
1281TX/2 T7-T9	10,10		012810350
1281TX/3 T10-T15	10,10		012810351
1281TX/4 T20-T25	10,10		012810352
1281TX/5 T30-T40	10,10		012810353

## 1281RTX

lâmina reversível intermutável para parafusos de perfil Tamper Resistant Torx®



	€	5	012810361
1281RTX/3 T10-T15	10,30		
1281RTX/4 T20-T25	10,30		012810362
1281RTX/5 T30-T40	10,30		012810363

## 1281BG/A9

jogo 9 chaves reversíveis e 1 acessório em bolsa



	€	1	012810520
1281BG/A9	110,00		

	1281BG
+	1281LPH/1 PH0-0,8x4 mm
+	1281LPH/2 PH1-1x5,5 mm
+	1281LPH/3 PH2-1,2x6,5 mm
+	1281PZ/1 PZ1-PZ2
○	1281PE 2,5 mm
○	1281PE 3 mm
○	1281PE 4 mm
○	1281PE 5 mm
○	1281PE 6 mm

## 1281BG-TX/A8

jogo 8 chaves reversíveis e 1 acessório em bolsa



	€	1	012810530
1281BG-TX/A8	104,50		

	1281BG
+	1281LPH/1 PH0-0,8x4 mm
+	1281LPH/2 PH1-1x5,5 mm
+	1281LPH/3 PH2-1,2x6,5 mm
○	1281TX/1 T6-T8
○	1281TX/2 T7-T9
○	1281TX/3 T10-T15
○	1281TX/4 T20-T25
○	1281TX/5 T30-T40

## 1281BG/B28A

jogo de 16 lâminas reversíveis intermutáveis, 9 chaves de caixa 1/4", 2 acessórios e 1 punho, em bolsa



	€	1	012810510
1281BG/B28A	242,00		

○ 900	4 - 4,5 - 5 - 5,5 6 - 7 - 8 - 9 - 10 mm
1281BG	
1281PB	■ 1/4
900/25	
1281LP/1	0,8x4 - 1,2x6,5 mm
1281LP/2	1,0x5,5 - 1,2x6,5 mm
1281PH/1	PH1 - PH2
1281PH/2	PH2 - PH3
1281PZ/1	PZ1 - PZ2
1281PZ/2	PZ2 - PZ3
1281PE	2,5 - 3 - 4 - 5 - 6 mm
1281TX/1	T6 - T8
1281TX/2	T7 - T9
1281RTX/3	T10 - T15
1281RTX/4	T20 - T25
1281RTX/5	T30 - T40

	€	1	012810501
1281/BV	14,80		

## 1290

chaves para parafusos de perfil de fenda



ISO 2380

SxAL mm	L1 mm	Ø mm	€	5	012900003
0,4x2,5x50	146	2,5	6,00		
0,4x2,5x75	171	2,5	6,15		012900006
0,5x3x75	171	3,0	6,25		012900009
0,5x3x100	196	3,0	6,55		012900012
0,6x3,5x75	171	3,5	7,20		012900018
0,6x3,5x100	196	3,5	7,35		012900021
0,8x4x100	196	4,0	7,35		012900030
0,8x4x125	221	4,0	7,65		012900033
0,8x4x150	246	4,0	8,00		012900036
1x5,5x100	209	5,0	8,20		012900039
1x5,5x150	259	5,0	9,30		012900042
1,2x6,5x100	220	6,0	10,30		012900048
1,2x6,5x150	270	6,0	10,90		012900051
1,2x8x150	282	7,0	13,70		012900057
1,2x8x200	332	7,0	14,40		012900060
1,6x10x200	332	8,0	17,10		012900066
2x12x250	382	10	22,90		012900069



# Beta INOX

STAINLESS STEEL

240

## 1290/S

jogo de chaves de parafusos



1290/S5	€	🔧	📄
1290	47,50	1	012900305
0,5x3x75-0,8x4x100 -1x5,5x150 1,2x6,5x150 -1,2x8x150 mm			

1290/S9X	€	🔧	📄
1290	89,50	1	012900319
0,4x2,5x75 - 0,5x3,5x100 0,8x4x125 - 1x5,5x150 1,2x6,5x150 - 1,2x8x200 1,6x10x200 mm			
1290N			
0,8x4x30 -1,2x6,5x30 mm			

## 1290N

chaves série curta para parafusos de perfil de fenda

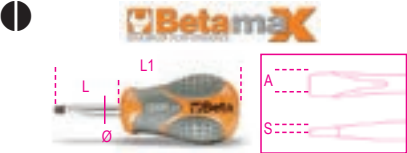

ISO 2380

SxAxL mm	L1 mm	Ø mm	€	🔧	📄
0,8x4x30	86	4	7,85	5	012900103
1,2x6,5x30	86	6	8,75	5	012900106

## 1292

chaves para parafusos de perfil Phillips®



UNI/ISO 8764

PHxDxL mm	L1 mm	€	🔧	📄
0x3x60	156	5,80	10	012920003
0x3x100	196	6,45	5	012920006
1x4,5x80	189	7,85	10	012920009
1x4,5x120	229	8,65	10	012920012
2x6x100	220	10,40	10	012920018
2x6x150	270	11,40	10	012920021
3x8x150	282	14,30	3	012920024
4x10x200	332	19,90	3	012920027

+



1292/S4	€	🔧	📄
PH0x3x60-PH1x4,5x80 PH2x6x100-PH3x8x150 mm	38,50	1	012920304

## 1292N

chaves série curta para parafusos de perfil Phillips®



UNI/ISO 8764

PHxDxL mm	L1 mm	€	🔧	📄
1x4,5x30	86	7,45	5	012920103
2x6x30	86	8,10	5	012920106

## 1292L

chaves série longa para parafusos de perfil Phillips®



UNI/ISO 8764-1

PHxDxL mm	L1 mm	€	🔧	📄
0x3x300	396	12,60	3	012920203
1x4,5x400	509	15,50	3	012920206
2x6x400	520	19,30	3	012920209

# Beta INOX

STAINLESS STEEL

240

## 1293/D...

jogo de chaves de parafusos



1293/D6	€	🔧	📄
1290	51,50	1	012930401
0,6x3,5x75-1x5,5x150 1,2x6,5x150 mm			
1292			
PH0x3x60 -PH1x4,5x80 PH2x6x100 mm			

1293/D8	€	🔧	📄
1290	71,50	1	012930403
0,5x3x75-0,8x4x100 1x5,5x150-1,2x6,5x150 1,2x8x150 mm			
1292			
PH0x3x60 -PH1x4,5x80 PH2x6x100 mm			

## 1293/S...

jogo de chaves de parafusos



1293/S8	€	🔧	📄
1290	64,00	1	012930208
2,5x50-3x75-4x100-5,5x150 6,5x150 mm			
1292			
PH0x3x60-PH1x4,5x80 PH2x6x100 mm			

1293/S10	€	🔧	📄
1290	101,50	1	012930201
0,4x2,5x50 -0,6x3,5x100 1x5,5x100-1,2x6,5x150 1,2x8x150-1,6x10x200 mm			
1292			
PH0x3x60 -PH1x4,5x80 PH2x6x100-PH3x8x150 mm			

1293/S12	€	🔧	📄
1290	111,00	1	012930203
0,5x3x75-0,8x4x125 1x5,5x150-1,2x6,5x150 1,2x8x200 mm			
1290N			
0,8x4x30 mm			
1292			
PH0x3x60 -PH1x4,5x80 PH2x6x100-PH3x8x150 mm			
1292N			
PH1x4,5x30-PH2x6x30 mm			

1293/S7	€	🔧	📄
1292	52,00	1	012930207
PH0x3x60 -PH1x4,5x80 PH2x6x100 mm			
1294			
0,5x2,5x60-0,6x3x75 0,8x4x100-1x5x125 mm			

# Beta

## 1293ES

chaves hexagonal macho com punho



mm	L mm	L1 mm	Ø mm	€	U	W
2	100	196	3	8,00	5	012930001
2,5	100	196	4	8,00	5	012930002
3	100	196	4	8,30	5	012930003
4	100	196	5	9,40	5	012930004
5	100	209	6	10,30	5	012930005
6	125	245	7	11,80	5	012930006
8	150	282	10	15,30	2	012930008



1293ES/S7 € 71,00 1 012930057  
2-2,5-3-4-5-6-8 mm

## 1293BP

chaves hexagonal macho com extremidade esférica e punho



mm	L mm	L1 mm	€	U	W
2	100	196	8,10	5	012930501
2,5	100	196	8,10	5	012930502
3	100	196	8,40	5	012930503
4	100	196	9,40	5	012930506
5	100	209	10,30	5	012930509
6	125	245	12,00	5	012930512
8	150	282	16,20	2	012930515



1293BP/S7 € 72,50 1 012930558  
2-2,5-3-4-5-6-8 mm

## 1294

chaves para parafusos de perfil de fenda sem cabeça



SxDxL mm	L1 mm	€	U	W
0,5x2,5x60	156	5,60	5	012940003
0,6x3x75	171	5,80	5	012940006
0,6x3x100	196	6,00	5	012940009
0,8x4x100	196	7,35	5	012940012
0,8x4x150	246	9,75	5	012940015
1x5x125	234	8,95	5	012940018
1,2x6,5x150	282	10,70	5	012940027



1294/S5 € 39,00 1 012940305  
0,5x2,5x60-0,6x3x100  
0,8x4x100-1x5x125  
1,2x6,5x150 mm

## 1294L

chaves série longa para parafusos de perfil de fenda sem cabeça

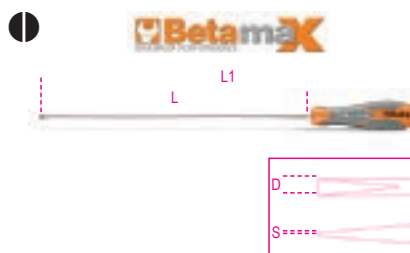

SxDxL mm	L1 mm	€	U	W
0,6x3x300	396	11,90	3	012940206
0,8x4x400	496	14,20	3	012940209
1x5x400	509	17,30	3	012940215
1,2x6,5x400	532	19,30	3	012940218

## 1295

desandador de percussão



1295/S12 € 53,50 1 012950001  
L mm 130

## 1295/C14

desandador de percussão com 14 pontas e 1 porta pontas



1295/C14 € 127,00 1 012950108

866LP	1,2x6,5 - 1,6x10 mm
866PH	PH2 - PH3
866PZ	PZ2 - PZ3
866PE	5 - 6 mm
866TX	T27 - T30 - T40 - T45 - T50 - T55
895/6	□ 1/2 - ○ 5/16
1295	■ 1/2

170x100x35 mm - 1,3 kg

## 1297TX

chaves com punho para parafusos de perfil Torx®



Ø mm	L mm	L1 mm	Ø mm	€	U	W
T6	50	146	3,0	10,60	5	012970006
T7	50	146	3,0	10,80	5	012970007
T8	60	156	3,0	10,90	5	012970008
T9	60	169	4,0	11,50	5	012970009
T10	80	189	4,0	12,00	5	012970010
T15	80	189	4,0	12,10	5	012970015
T20	100	209	4,5	12,60	5	012970020
T25	100	209	5,0	13,00	5	012970025
T27	115	235	6,0	13,30	5	012970027
T30	115	235	6,0	14,00	5	012970030
T40	130	262	7,0	15,30	2	012970040
T45	130	262	8,0	17,50	2	012970045



1297TX/S12 € 154,00 1 012970312  
T6-T7-T8-T9-T10  
T15-T20-T25-T27  
T30-T40-T45

# Beta

**Betamax**

1297TX/D6 € 77,00 1 012970409  
 T10-T15-T20  
 T25-T27-T30

**1298RTX**

chaves com punho para parafusos  
 de perfil Tamper Resistant Torx®

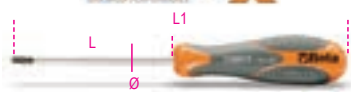
**Betamax**

⊕	L mm	L1 mm	∅ mm	€	1	012980009
T9	60	169	4,0	12,60	5	012980009
T10	80	189	4,0	12,80	5	012980010
T15	80	189	4,0	13,60	5	012980015
T20	100	209	4,0	13,70	5	012980020
T25	100	209	4,5	14,00	5	012980025
T27	115	235	5,5	14,80	5	012980027
T30	115	235	6,0	15,30	5	012980030
T40	130	262	7,0	16,30	2	012980040

**Betamax**

1298RTX/S8 € 113,00 1 012980308  
 T9-T10-T15-T20  
 T25-T27-T30-T40

**1299PZ**

chaves para parafusos  
 de perfil Pozidriv® - Supadriv®

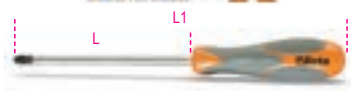
**Betamax**

UNI/ISO 8764

⊕	PZ	L mm	L1 mm	€	1	012990000
	0	60	156	8,00	5	012990000
	1	80	189	9,50	5	012990003
	2	100	220	13,30	5	012990006
	3	150	282	19,30	2	012990009
	4	200	332	27,00	2	012990012

**Betamax**

1299PZ/S6 € 70,00 1 012990306  
 1299PZ PZ0-PZ1-PZ2-PZ3  
 1299N/PZ PZ1-PZ2

**1299N/PZ**

chaves série curta para parafusos  
 de perfil Pozidriv® - Supadriv®

**Betamax**

UNI/ISO 8764

⊕	PZ	L mm	L1 mm	€	1	012990021
	1	30	86	9,40	5	012990021
	2	30	86	10,40	5	012990024

**1302**

encontrador duplo com punho  
 com almofada convexa e pena



770 g € 82,00 1 013020001

**1303**

encontrador tipo virgula



1350 g € 62,50 1 013030001

**1304**

encontrador tipo palmilha com entalhe



875 g € 80,00 1 013040001

**1305**

encontrador curvo



1190 g € 49,00 1 013050001

**1305Z**

encontrador curvo serrilhado



1065 g € 58,50 1 013050002

**1306**

encontrador tipo tacão



1040 g € 47,00 1 013060001

**1307**

encontrador rectangular

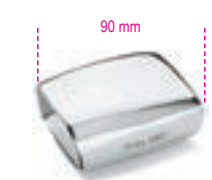

1100 g € 92,00 1 013070001

**1308**

encontrador oval



1100 g € 85,50 1 013080001

**1309**

encontrador de pena dupla



g 460 € 54,50 1 013090001

**1310**

encontrador tipo trilho



g 1225 € 52,50 1 013100001

**1312**

encontrador tipo bigorna



g 1220 € 112,00 1 013120001

**1313**

encontrador tipo tampão



g 990 € 76,50 1 013130001

**1314**

encontrador redondo duplo com almofadas convexa e plana



g 760 € 50,50 1 013140001

**1326**

colher estreita simples



g 560 € 45,50 1 013260001

**1327**

colher larga simples



g 1075 € 64,00 1 013270001

**1328**

colher côncava simples



g 935 € 57,50 1 013280001

**1329**

colher dupla com mesas largas



g 1800 € 174,00 1 013290001

**1330**

colher dupla pescoço de cisne com mesas largas



g 2125 € 185,00 1 013300001

**1331**

colher curva com face em couro



g 1100 € 102,50 1 013310001

**1335BM**

lima de bancada com punho plástico



g 500 € 31,00 2 013350010

**1337/S5**

jogo de 5 espátulas para reparação auto, em aço inoxidável

Tipo Japonês  
(25-50-75-100-125 mm)



L mm € 11,50 1 013370015

**1338A - 1338B**

armações flexíveis com lima de chapeiro



	mm / 1"	L mm	€		
1338A	9	360	86,50	2	013380001
1338B	12	360	89,50	2	013380002

**1338**

armação para limas para refª. 1338R



g 1338 € 47,50 2 013380003

### 1338R9 - 1338R12

limas de substituição  
para ref<sup>as</sup>. 1338A-B



1338R9	9	€ 39,00	2	013380004
1338R12	12	€ 42,00	2	013380005

### 1342

talhadeira extra-chata com lâmina direita



L mm	€	2	013420001
235	26,00	5	

### 1342PM

talhadeira chata com cortante direito  
com punho de protecção

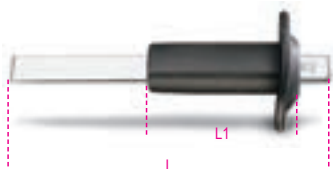

L mm	L1 mm	€	2	013420002
235	118	37,50		

### 1342PMR

punho de protecção para ref<sup>a</sup>. 1342



1342PMR	€ 10,90	1	013420003
---------	---------	---	-----------

### 1343

talhadeira chata com lâmina oblíqua



L mm	€	5	013430001
200	28,00		

### 1344

Apalpa folgas para bate-chapas ,  
par, 10-lâminas, com ventosa de  
apoio

Indicado para :  
- colocação de vidros traseiros  
- controlo de distância entre painéis



1344	€ 33,00	1	013440010
------	---------	---	-----------

### 1345

martelo com cabeça convexa redonda  
e pena, larga cabo em madeira



1345	€ 39,50	2	013450010
------	---------	---	-----------

### 1351

martelo com cabeça plana redonda  
e pena pontiaguda, cabo em madeira



1351	€ 40,50	2	013510010
------	---------	---	-----------

### 1353

martelo com cabeças redondas plana  
e convexa, cabo em madeira



1353	€ 41,50	2	013530010
------	---------	---	-----------

### 1357Z/45

martelo com cabeça redonda  
serrilhada e quadrada plana,  
cabo em madeira



1357Z/45	€ 63,50	2	013570045
----------	---------	---	-----------

### 1359T

martelo com cabeça plana redonda  
e pena horizontal, cabo em madeira

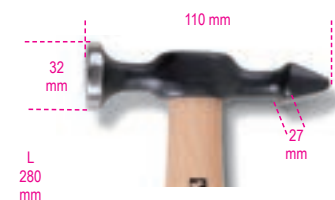

1359 T	€ 39,50	2	013590010
--------	---------	---	-----------

### 1360/K6

Martelo de alumínio com batente plano, com  
pinos de plástico intermutáveis e punção

Fornecido com :  
- 4 pinos de plástico  
- 1 punção, ajustável  
em dois comprimentos diferentes, aplicável ao martelo



L mm	Ø mm	€	1	013600006
320	34	76,50		

### 1362

Refletor de mossas  
com ventosa

Permite detetar mesmo  
as imperfeições mais pequenas



LxH mm	€	1	013620010
240 x 200	70,50		



## 1365/K13

kit chapeiro com bomba hidráulica 10 t e acessórios em trolley

O kit inclui:

- bomba hidráulica, 10 t, com tubo 1,5 m comp., união1/2"
- pistão
- pinça; capacidade: 500 kg
- placa base, 150x90 mm
- base em L, 50x50 mm
- punção 4 pontos
- punção redonda, Ø 50 mm
- punção cunha, 43 mm
- extensão 240-mm
- extensão 450-mm
- extensão 475-mm
- cabeça em borracha
- união macho-macho para instalar acessórios



1365/K13 € 592,00 1 013650013

≡ 900x420x180 mm

## 1365P10

bomba hidráulica

tubo 1,5m comp, união 1/2"



1365P10 € 264,00 1 013650110

## 1366A

Tira mossas com kit de 19 pinos plásticos

Ideal para remover:

- mossas causadas por granizo
- mossas no estacionamento
- pequenas mossas em geral



1366A € 77,50 1 013660200

## 1366KF

Conjunto de 19 pinos plásticos, para artigo 1366A



1366KF € 28,50 1 013660205

## 1366/K5

tira-mossas pneumático, com percutor de 1.1 kg

O kit inclui:

- 1 ventosa Ø 75 mm
- 1 ventosa Ø 100 mm
- 1 ventosa Ø 125 mm
- 1 gancho



1366/K5 € 203,00 1 013660010

≡ 610x240x90 mm

## 1366S

aparelho de soldar por pontos com rodas

- microprocessador para gestão dos parâmetros de soldadura
- regulação da potência e tempo de soldadura
- intervalo de regulação: 400÷2200 Ah
- seletor de pontos simples, pulsados e contínuos
- tabela com parâmetros de soldadura
- indicador de proteção térmica
- pistola de aperto rápido
- voltagem: 230 V

CE



1366S € 1.415,00 1 013660000

## 1366S KIT

kit de acessórios soldadura por pontos

- 10 anilhas ranhuradas
- 10 anilhas ranhuradas 90°
- 100 pinos roscados, 5x18 mm
- 100 pinos auto-roscantes, 5x18 mm
- 100 pinos auto-roscantes, 5x25 mm
- Gancho de anilha, Ø 8x16x1.5 mm
- Eléctrodo para parafusos M5-M6
- Eléctrodo para anilhas ranhuradas



1366S KIT € 188,00 1 013660001

≡ 250x170x35

## 1366SL

alavanca tira-mossas para superfícies metálicas

Cabeça articulada com garra para utilização com arame ondulado



L mm € 164,00 1 013660002

## 1366ST

barra tira-mossas para superfícies metálicas e alumínio

Cabeça articulada com garra para utilização com arame ondulado e olhas de tração



L mm € 524,00 1 013660003

## 1366S/R1

Mandril 3 pontas



1366S/R1 € 20,20 1 013660501

### 1366S/R2

Anilhas de 3 pontas para trabalhos em chapa



1366S/R2 € 20,20 1 013660502

### 1366S/R3

electrodo para anilhas Ø 8x16x1.5 mm



1366S/R3 € 24,00 1 013660503

### 1366S/R4

Grampo, Ø 8x16x1.5 mm



1366S/R4 € 20,80 1 013660504

### 1366S/R5

Anilhas Ø 8x16x1.5mm



1366S/R5 € 11,50 1 013660505

### 1366S/R6

Electrodo para parafusos M5-M6



1366S/R6 € 24,00 1 013660506

### 1366S/R7

100 pinos auto-roscentes, 5x18 mm



1366S/R7 € 20,20 1 013660507

### 1366S/R8

100 pinos auto-roscentes, 5x25 mm



1366S/R8 € 28,00 1 013660508

### 1366S/R9

100 pinos rosçados, M5 x 18 mm



1366S/R9 € 18,60 1 013660509

### 1366S/R10

10 anilhas com fenda



1366S/R10 € 12,80 1 013660510

### 1366S/R11

Electrodo para anilhas com fenda



1366S/R11 € 67,50 1 013660511

### 1366S/R12

Anilhas com fenda 10 90°



1366S/R12 € 25,50 1 013660512

### 1366S/R13

Eléctrodo de soldadura por pontos



1366S/R13 € 49,00 1 013660513

### 1366S/R14

Eléctrodo de soldadura por pontos



1366S/R14 € 23,50 1 013660514

### 1366S/R21

arame ondulado para utilização com alavanca e barra tira-mossas



1366S/R21 € 54,50 1 013660551

### 1366S/R22

suporte magnético para arame ondulado



1366S/R22 € 16,40 1 013660552

### 1366S/R24

olhal de tração M4



1366S/R24 € 64,50 1 013660554

### 1366S/R25

olhal de tração M5



1366S/R25 € 64,50 1 013660555

### 1366S/R26

olhal de tração M6



1366S/R26 € 64,50 1 013660556

## 1367/S6

Jogo de punções para instalação de sensores de estacionamento

Tamanhos:  
17 - 18 - 19 - 20 - 21 - 22 mm



1367/S6	€ 216,00	1	013670100
---------	----------	---	-----------

## 1367

punções para instalação de sensores de estacionamento



Ø mm	Ø mm	€	1	Artigo
17	13	44,00	1	013670117
18	13	44,00	1	013670118
19	13	44,00	1	013670119
20	13	44,00	1	013670120
21	13	44,00	1	013670121
22	13	44,00	1	013670122
23	13	47,00	1	013670123
24	13	47,00	1	013670124
27	13	47,00	1	013670127
28	13	47,00	1	013670128

## 1368

kit de reparação para plásticos

• Permite reparar rapidamente componentes em plástico rachados ou partidos

Potência: 220+240 V com tomada Schuko  
Extensão cabo pistola de calor: 3.5 m  
Comp. cabo eléctrico: 1.35 m  
2 regulações de potência: 35-75 W  
Pistola de aquecimento com terminais em latão, 2 ângulos de inserção do grampo: 0°-90°  
Quebra-circuitos térmico de segurança na entrada  
Fusível 10 A de segurança na saída  
Bolsa para pistola



1368	€ 370,00	1	013680001
------	----------	---	-----------

## 1368G/K400

sortido de 400 grampos para artigo 1368



1368G/K400	€ 61,50	1	013680140
------------	---------	---	-----------

## 1368G/OD

grampos roscados, a direito, para artigo 1368



1368G/OD	€ 15,30	1	013680100
----------	---------	---	-----------

## 1368G/SD

grampos em espiral, a direito, para artigo 1368



1368G/SD	€ 15,30	1	013680110
----------	---------	---	-----------

## 1368G/CV

grampos ângulo convexo para artigo 1368



1368G/CV	€ 15,30	1	013680120
----------	---------	---	-----------

## 1368G/C2U

grampos ângulo côncavo para artigo 1368



1368G/C2U	€ 15,30	1	013680130
-----------	---------	---	-----------

## 1369/C11

jogo de 11 ferramentas



1369/C11	€ 714,00	1	013690033
----------	----------	---	-----------

- 1303
- 1305
- 1306
- 1309
- 1310
- 1314
- 1327
- 1338A
- 1353
- 1357Z/40
- 1390

470x340x70 mm - 15,2 kg

## 1370

martelos para mecânico tipo alemão, cabo em madeira



UNI 7778 DIN 1041

HICKORY

g	A mm	L mm	L1 mm	€	5	Artigo
100	15	260	82	10,40	5	013700051
200	19	280	95	11,80	5	013700052
300	23	300	105	13,50	5	013700053
400	25	310	112	15,20	5	013700054
500	27	320	118	16,40	5	013700055
600	30	330	122	19,10	5	013700056
800	33	350	130	21,60	4	013700058
1000	36	360	135	25,00	4	013700060
1500	42	380	145	29,50	2	013700065
2000	47	400	155	35,00	1	013700070

## 1370/MR...

cabos de substituição para referência 1370



Artigo	€	4	Artigo
1370MR 100 1370/100	4,80	4	013700081
1370MR 200 1370/200	5,25	4	013700082
1370MR 300 1370/300	5,70	4	013700083
1370MR 400 1370/400	6,00	4	013700084
1370MR 500 1370/500	6,65	4	013700085
1370MR 600 1370/600	7,45	4	013700086
1370MR 800 1370/800	7,75	4	013700088
1370MR 1000 1370/1000	8,20	4	013700090
1370MR 1500 1370/1500	9,30	4	013700095
1370MR 2000 1370/2000	10,40	4	013700100

## 1370T

martelos para mecânico cabo em fibra



g	A mm	L mm	L1 mm	€	5	Artigo
200	19	280	95	18,00	5	013700620
300	23	300	105	19,70	5	013700630
500	27	320	118	21,30	5	013700650
800	33	350	130	22,90	4	013700680
1000	36	360	135	29,50	4	013700700
1500	42	365	145	34,50	2	013700750



## 1370F

martelos para mecânico tipo alemão, cabo em madeira



NF E 71.014

A mm	L mm	L1 mm	g	€	U	Art
24	260	77	280	18,60	2	013700424
26	260	80	310	19,70	2	013700426
28	280	86	400	20,80	2	013700428
30	280	92	450	21,30	2	013700430
32	300	100	550	22,90	2	013700432
36	300	104	720	29,50	2	013700436
40	330	110	1065	33,50	2	013700440
42	330	116	1080	34,50	2	013700442
50	380	138	1760	37,00	2	013700450
60	380	160	2585	44,50	2	013700460

## 1370F/MR...

cabos de substituição para referência 1370F



Art	€	U
1370F/MR 24 1370F/24-26	4,70	2 013700474
1370F/MR 28 1370F/28-30	4,95	2 013700478
1370F/MR 32 1370F/32-36	5,80	2 013700482
1370F/MR 40 1370F/40-42	7,45	2 013700490
1370F/MR 50 1370F/50	8,30	2 013700495
1370F/MR 60 1370F/60	10,20	2 013700496

## 1370FT

martelos para mecânicos, cabos em fibra



A mm	L mm	L1 mm	g	€	U	Art
28	280	86	530	31,00	1	013700528
30	280	92	625	32,00	1	013700530
32	300	100	750	34,00	1	013700532
36	300	104	930	39,50	1	013700536
40	330	110	1150	41,50	1	013700540
42	330	116	1250	43,00	1	013700542
50	380	138	2100	47,50	1	013700550
60	380	160	2750	51,00	1	013700560

## 1374F

martelo para carpinteiro tipo francês, cabo em madeira



NF E 71.012

A mm	L mm	L1 mm	g	€	U	Art
16	250	80	180	14,80	2	013740416
20	270	86	250	16,40	2	013740420
22	290	92	335	16,90	2	013740422
26	290	103	425	18,60	2	013740426
28	310	108	510	19,70	2	013740428
30	310	117	580	21,30	2	013740430

## 1374F/MR...

cabos de substituição para referência 1374F



Art	€	U
1374F/MR 16 1374F/16	4,30	2 013740456
1374F/MR 20 1374F/20	4,40	2 013740460
1374F/MR 22 1374F/22-26	4,50	2 013740462
1374F/MR 28 1374F/28	5,05	2 013740468
1374F/MR 30 1374F/30	5,25	2 013740470

## 1375

martelo de orelhas, cabo em madeira



g	L1 mm	Ø mm	L mm	€	U	Art
300	95	25	300	16,40	3	013750000

## 1375/MR

cabos de substituição para referência 1375



Art	€	U
1375/MR	7,45	2 013750003

## 1375A

martelo de orelhas, cabo em material plástico



oz	g	L mm	L1 mm	€	U	Art
16	450	330	130	24,90	3	013750016
20	570	330	130	26,00	3	013750020

## 1375B

martelo de orelhas, cabo em aço



oz	g	L mm	L1 mm	€	U	Art
16	450	330	130	22,40	3	013750026
20	570	330	130	22,90	3	013750030

## 1376X

martelo de carpinteiro com orelhas magnetizadas, cabo de madeira



g	A mm	L1 mm	L mm	€	U	Art
250	20	125	450	15,90	3	013760125
300	25	130	450	16,90	3	013760130
400	27	132	450	18,00	3	013760140

## 1376X/MR

cabo de substituição para o artigo 1376X



Art	€	U
1376X/MR	9,05	2 013760161

## 1376XT

martelo de carpinteiro com orelhas magnetizadas, cabo em material plástico



g	A mm	L1 mm	L mm	€	U	Art
250	20	125	500	19,70	3	013760525
300	25	130	500	20,80	3	013760530
400	27	132	500	21,80	3	013760540

## 1376XT/MR

cabo de substituição para o artigo 1376XT



Art	€	U
1376XT/MR	10,20	2 013760585

## 1377

martelos com batente redondo e pena esférica, cabo em madeira



g	L mm	L1 mm	€	U	Art
340	330	95	24,60	2	013770134
450	350	102	25,50	2	013770145
570	350	110	29,50	2	013770157
680	360	116	30,00	2	013770168
900	380	120	33,00	2	013770190

## 1377/MR...

cabos de substituição  
para referência 1377



	€		
1377MR 340 1377/340	5,25	2	013770234
1377MR 450 1377/450	6,15	2	013770245
1377MR 570 1377/570	6,80	2	013770257
1377MR 680 1377/680	6,90	2	013770268
1377MR 900 1377/900	8,55	2	013770290

## 1377T

Martelo batente redondo e pena simétrica,  
cabo redondo em fibra, para trabalhos em  
latão ou estanho



g	L mm	L1 mm	€		
340	330	95	22,40	2	013770534
450	350	102	27,00	2	013770545
570	350	110	30,00	2	013770557
680	360	116	32,50	2	013770568
900	380	120	37,00	2	013770590

## 1378

martelos com batente redondo  
e pena simétrica, cabo em madeira



g	L mm	L1 mm	Ø mm	€		
340	330	100	27	22,40	2	013780134
570	350	115	32	29,50	2	013780157

## 1378/MR...

cabos de substituição  
para referência 1378



	€		
1378MR 340 1378/340	5,05	2	013780234
1378MR 570 1378/570	7,00	2	013780257

## 1379F

martelo tipo francês para electricista,  
cabo em madeira



NF E 71.011

A mm	L mm	L1 mm	€		
16	250	126	14,80	2	013790416
18	250	135	15,90	2	013790418
20	260	142	16,90	2	013790420

## 1379F/MR...

cabos de substituição  
para referência 1379F



	€		
1379F/MR 16 1379F/16-18	4,60	2	013790426
1379F/MR 20 1379F/20	5,05	2	013790430

## 1380

marretas cabo em madeira



UNI 7777 DIN 6475

g	A mm	L mm	L1 mm	€		
800	38	260	90	18,60	2	013800208
1000	40	260	95	20,20	2	013800210
1250	43	260	100	21,30	2	013800212
1500	45	280	110	24,00	2	013800215
2000	50	300	120	32,00	2	013800220

## 1380/MR...

cabos de substituição para referência 1380



	€		
1380MR 800 1380/800-1000-1250	5,90	2	013800238
1380MR 1500 1380/1500	6,35	2	013800245
1380MR 2000 1380/2000	7,10	2	013800250

## 1380S

marretas com colar salva mãos  
cabo em madeira



g	A mm	L mm	L1 mm	€		
800	36	260	90	20,20	2	013800400
1000	39	260	95	22,40	2	013800405
1250	43	260	100	24,00	2	013800410
1500	45	260	110	27,00	2	013800415

## 1380S/MR...

cabos de substituição  
para referência 1380S



	€		
1380S/MR 800 1380S/800-1000-1250	6,25	2	013800417
1380S/MR 1500 1380S/1500	6,80	2	013800419

## 1380T

Marreta,  
cabo em fibra



g	A mm	L mm	L1 mm	€		
800	35	260	85	28,50	2	013800308
1000	40	260	100	29,00	2	013800310
1250	42	260	110	31,50	2	013800312
1500	45	260	120	34,00	2	013800315

## 1381

marretas serviço pesado  
cabo em madeira de castanheiro americano



g	A mm	L mm	L1 mm	€		
3000	55	800	142	75,50	1	013810030
4000	60	900	152	84,00	1	013810040
5000	70	900	162	95,50	1	013810050
8000*	80	900	185	164,00	1	013810080

\* = cabo em madeira freixo

## 1381/MR...

cabos de substituição  
para referência 1381

	€		
1381MR 3-4 1381/3000-4000	38,50	2	013810730
1381MR 5 1381/5000	40,00	2	013810750
1381MR 8 1381/8000	40,50	2	013810780

## 1381T

marreta com cabo em fibra



g	A mm	L mm	L1 mm	€		
3000	55	900	142	83,00	1	013810330
4000	60	900	152	91,50	1	013810340
5000	70	900	162	103,50	1	013810350

## 1385

marretas com cabeça em cobre  
cabo em madeira



g	A mm	L mm	L1 mm	€		
400	26	260	75	28,50	2	013850404
600	32	270	80	41,00	2	013850406
800	34	280	90	53,50	2	013850408
1000	37	280	100	66,50	2	013850410
1500	43	280	110	98,50	2	013850415
2000	48	300	120	132,00	1	013850420

## 1385/MR

cabo de substituição para o artigo 1385



	€		
1385MR 400 1385 400	8,40	2	013850464
1385MR 600 1385 600	8,65	2	013850466
1385MR 800 1385 800	8,95	2	013850468
1385MR 1000 1385 1000	9,50	2	013850470
1385MR 1500 1385 1500	10,40	1	013850475
1385MR 2000 1385 2000	10,90	1	013850480

## 1390

martelos com batentes plásticos  
intermutáveis, cabo em madeira



UNI 7784

Ø mm	L mm	L1 mm	€		
22	260	70	16,40	5	013900022
28	280	85	20,20	5	013900028
35	310	95	27,50	5	013900035
45	320	107	44,00	4	013900045
60	380	128	75,00	2	013900060

## 1390/MR...

cabos de substituição  
para referência 1390



	€		
1390MR 22 1390/22	4,05	2	013900222
1390MR 28 1390/28	4,60	2	013900228
1390MR 35 1390/35	5,45	2	013900235
1390MR 45 1390/45	6,65	2	013900245
1390MR 60 1390/60	8,30	2	013900260

## 1390R

batente de substituição para refª. 1390



Ø mm	€		
22	2,55	4	013900122
28	3,95	4	013900128
35	5,30	4	013900135
45	9,05	4	013900145
60	15,70	4	013900160

## 1390N

Martelo com batentes em plástico, cabo em madeira

Batentes dureza média: 75 Shore  
Resistente a óleo e ao desgaste  
Particularmente adequado para trabalhar metal



Ø mm	L mm	L1 mm	€		
22	260	70	16,40	3	013900522
28	280	85	20,20	3	013900528
35	310	95	27,50	3	013900535
45	320	107	44,00	2	013900545
60	380	128	75,00	2	013900560

## 1390NR

batentes em nylon de substituição para ref. 1390N



Ø mm	€		
22	2,55	4	013900622
28	3,95	4	013900628
35	5,30	4	013900635
45	9,05	4	013900645
60	15,70	4	013900660

## 1391

martelos anti-recuo totalmente  
revestidos a borracha



Ø mm	L mm	L1 mm	€		
35	280	90	25,00	2	013910135
50	320	105	33,50	2	013910150
55	355	110	39,50	2	013910155
65	380	130	53,50	2	013910165

## 1391A

maceta para assentar tijoleira  
totalmente revestida a borracha branca



g	Ø mm	L mm	L1 mm	€		
500	45	290	100	24,00	2	013910205
1000	60	300	120	32,00	2	013910210

## 1392

martelos anti-recuo com batentes  
intermutáveis, cabo em aço



Ø mm	L mm	L1 mm	€		
30	300	105	43,00	2	013920030
35	305	115	46,00	2	013920035
40	310	125	52,00	2	013920040
50	325	135	62,50	2	013920050
60	385	155	95,00	2	013920060

## 1392R

batente de substituição para ref<sup>a</sup>. 1392



Ø mm	€	🔧	📦
30	5,70	4	013920230
35	8,40	4	013920235
40	12,70	4	013920240
50	16,90	4	013920250
60	25,50	4	013920260

## 1393

martelo com batente em borracha dura



Ø mm	L mm	L1 mm	€	🔧	📦
50	315	90	11,30	3	013930050
60	340	110	12,80	3	013930060
70	370	130	15,10	2	013930070

## 1410/M

chave de gancho para molas



Ø mm	€	🔧	📦
3,5	15,90	2	014100051

## 1428

extractor de porcas com quadra macho



mm	□	L mm	Ø mm	€	🔧	📦
8	3/8	36	17	15,90	2	014280008
10	3/8	36	17	15,90	2	014280010
11	3/8	36	17	15,90	2	014280011
12	3/8	36	19	15,90	2	014280012
13	3/8	36	19	15,90	2	014280013
14	3/8	36	19	15,90	2	014280014
15	1/2	38	21	16,90	2	014280015
16	1/2	38	21	16,90	2	014280016
17	1/2	38	21	16,90	2	014280017
18	1/2	38	26	16,90	2	014280018
19	1/2	38	26	16,90	2	014280019
20	1/2	38	26	18,60	2	014280020
21	1/2	38	26	18,60	2	014280021
22	1/2	38	26	20,20	2	014280022
24	1/2	38	26	20,20	2	014280024
27	1/2	38	26	21,30	2	014280027

## 1428L

extractores, série longa, para porcas de aperto direito danificadas, com quadra



mm	€	🔧	📦
17	41,00	1	014280217
19	42,00	1	014280219
21	45,50	1	014280221

12"



1428L/B3	€	🔧	📦
17-19-21 mm	129,00	1	014280303

38"



1428/SB11	€	🔧	📦
8-10-11-12-13-14 15-16-17-18-19 mm	193,00	1	014280111
1428/SB5	€	🔧	📦
20-21-22-24-27 mm	106,00	1	014280115

## 1429

extractor de porcas e parafusos com quadra macho



mm	□	L mm	€	🔧	📦
2	3/8	60	10,60	3	014290002
3	3/8	60	10,60	3	014290003
4	3/8	60	10,60	3	014290004
5	3/8	60	11,30	2	014290005
6	3/8	60	11,30	2	014290006
8	1/2	70	12,00	2	014290008
10	1/2	70	12,30	2	014290010

38"



1429/SB7	€	🔧	📦
2-3-4-5-6-8-10 mm	87,50	1	014290107

## 1430/...

extractores cónicos de parafusos em aço ligado

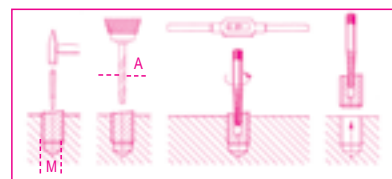

	M	A mm	€	🔧	📦
1430/1	3+6	2,5	3,00	10	014300006
1430/2	6+8	3,0	3,30	10	014300008
1430/3	8+11	4,5	3,95	10	014300011
1430/4	11+14	6,0	5,20	10	014300014
1430/5	14+18	8,0	5,90	10	014300018
1430/6	18+24	11,0	11,50	5	014300024
1430/7	24+33	14,0	17,40	5	014300033
1430/8	33+50	21,0	22,20	5	014300050



1430/S5	€	🔧	📦
1430/1-1430/2-1430/3 1430/4-1430/5	22,40	1	014300105
1430/S6	€	🔧	📦
1430/1-1430/2-1430/3 1430/4-1430/5-1430/6	33,00	1	014300106
1430/S8	€	🔧	📦
1430/1-1430/2-1430/3 1430/4-1430/5-1430/6 1430/7-1430/8	72,00	1	014300108

## 1433

Saca pernos

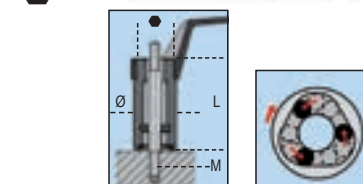

M mm	Ø mm	L mm	● mm	□	€	🔧	📦
5	21	60	19	3/8	11,80	2	014330005
6	24	60	21	1/2	11,80	2	014330006
7	24	60	21	1/2	11,80	2	014330007
8	24	60	21	1/2	11,80	2	014330008
9	28	70	21	1/2	13,90	2	014330009
10	28	70	21	1/2	13,90	2	014330010
10,5	28	70	21	1/2	13,90	2	014330021
11	28	70	21	1/2	13,90	2	014330011
12	28	70	21	1/2	13,90	2	014330012
14	36	72	24	-	21,80	2	014330014
16	36	72	24	-	21,80	2	014330016

## 1433/C11

saca pernos com roletes  
com encadouro quadrado fêmea 1/2"



1433/C11 228,00 € 1 014330311  
M5 - M6 - M7 - M8 - M9 - M10 - M10,5  
M11 - M12 - M14 - M16

340x135x56 mm - 3,0 kg

## 1435

extractor excêntrico de pernos



Ø mm 4÷20 87,50 € 1 014350001

## 1435R

patela excêntrica de substituição  
para a refª. 1435



1435R 26,00 € 1 014350010

## 1435/1

extractor excêntrico de pernos



Ø mm 19÷26 109,00 € 1 014350002

## 1435/1R

patela excêntrica de substituição  
para a refª. 1435/1



1435/1R 27,50 € 1 014350011

## 1437/C12

Jogo de 12 ferramentas para remoção de air  
bags



1437/C12 86,50 € 1 014370001

260x160x55 mm - 1,0 kg

## 1438

aparelho para centrar embraiagens  
com 3 cones expansivos



1438 46,50 € 1 014380001

## 1438R

cones expansivos de substituição  
para a refª. 1438



Ø mm 14÷18 3,20 € 5 014380101  
18÷21 3,20 € 5 014380102  
22÷25 3,20 € 5 014380103

## 1438K/DSG

jogo de 13 ferramentas para remoção,  
instalação e regulação de embraiagens dSg  
VW 6 e 7 velocidades

Permite trabalhar em transmissões automáticas e eletrônicas  
de caixas de velocidades duplas. Inclui alicate para  
remoção/ instalação de anéis de retenção do eixo principal e  
manômetro de regulação do sistema de embraiagem



1438K/DSG 803,00 € 1 014380250

## 1438DSG

Alavanca para bloquear/desbloquear caixas  
de velocidades DSG de dupla embraiagem do  
grupo VAG



1438DSG 27,50 € 1 014380200

## 1438SAC

aparelho para centrar embraiagens SAC  
(Bimassa)

Inclui kit para aplicações sem necessidade de guia de  
rolamentos  
Fornecido com acessório 3 e 4 braços



1438 SAC 1.036,00 € 1 014380050

480x380x130 mm - 9,5 kg

## 1439/K7

porta-pontas angular (90°), série longa,  
com pontas, em caixa

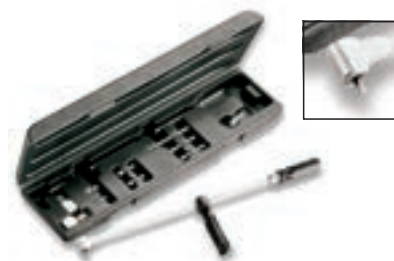

Conteúdo da caixa:  
- Porta-pontas angular  
- 1 cabeça para parafusos de perfil de fenda  
- 1 cabeça 1/4" para pontas  
- 1 cabeça especial para pontas  
- 7 pontas especiais

1439K7 175,00 € 1 014390101

500x120x60 mm 825 g

# Beta

## 1440/...

cintas para segmentos



	Ø mm	L mm	€		
1440/0	40÷75	50	25,00	1	014400000
1440/1	57÷125	80	34,00	1	014400010
1440/1A	57÷125	100	38,50	1	014400011
1440/2	90÷175	80	41,00	1	014400020
1440/2A	90÷175	100	43,00	1	014400021
1440/3	90÷175	165	63,50	1	014400030

## 1445/1 - 1445/2

grampo para segmentos



	Ø mm	€		
1445/1	50÷100	35,00	1	014450001
1445/2	90÷150	45,50	1	014450002

## 1450GC

grampo para válvulas com bicos direitos e curvos



	€		
1450GC	102,50	1	014500005

## 1452K

compressor de molas de válvulas, com três matrizes

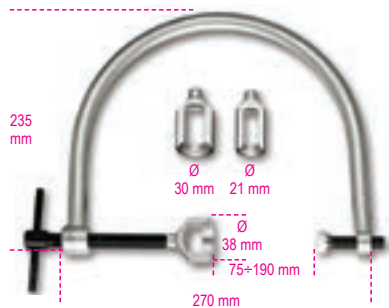

	€		
1452K	133,00	1	014520100

## 1452PN/K

compressor pneumático para molas de válvulas

Pressão de impulso: 1400 N



Ø mm	L mm	L1 mm	€		
16-19-23	230	185	287,00	1	014520110
25-30-42					

## 1455SVP

rectificador de válvulas pneumático

• Pressão de alimentação: 6 bar

CE



	€		
1455SVP	325,00	1	014550001

## 1455SVP/R...

ventosas em borracha de substituição para a refª. 1455SVP



	€		
1455SVP/R1	5,45	5	014550501
1455SVP/R2	5,45	5	014550502
1455SVP/R3	5,45	5	014550503

## 1457/B4

jogo de ferramentas para remover uniões de tubos Rilsan

Tamanhos incluídos:

- 6x8
- 10x12
- 15x16
- 18x12



	€		
1457/B4	41,50	1	014570024

## 1458

alicate para anéis de segurança



DIN 5417

Ø mm	€		
30÷100	65,00	2	014580001

## 1460F

alicate para as juntas de afinação das válvulas



	€		
1460F	54,50	1	014600010

## 1461/C3B

dispositivo de afinação para motores a gasolina

Fiat/Alfa/Lancia

Motores: 1.2-1.4 16V



	€		
1461/C3B	295,00	1	014610032

280x245x75 mm 1,5 kg

## 1461/C5G

dispositivo de afinação para motores a diesel

Fiat/Alfa/Lancia/Opel/Suzuki/Ford

Motores: 1.3 Multijet



	€		
1461/C5G	257,00	1	014610053

280x245x75 mm 2,6 kg

### 1461/C6B

dispositivo de afinação para motores a gasolina

Peugeot/Citroën

Motores: 1.0-1.1-1.4-1.6-1.6 16v-1.6Gti-1.6 18V-1.8-1.8 16v-1.9-2.0-2.0 16v-2.0T-2.0 Hpi-2.2 16v



1461/C6B € 404,00 1 014610063  
310x290x120 mm 3,5 kg

### 1461/C6G

dispositivo de afinação para motores a diesel Peugeot/Citroën

Motores: 1.4-1.6-2.0D,1.4-1.6TDCi, 1.4-1.6-2.0-2.2Hdi, 1.5-1.9-2.5D



1461/C6G € 524,00 1 014610064  
385x290x100 mm 3,8 kg

### 1461/C7B

dispositivo de afinação para motores a gasolina Renault/Nissan

Motores: 1.4-1.6-1.8-2.0 16V



1461/C7B € 306,00 1 014610072  
280x245x75 mm 3,2 kg

### 1461/C8B

dispositivo de afinação para motores a gasolina

Ford

Motores: 1.25-1.4-1.6-1.6 SCTi-1.6 Ti-VCT-1.6 16V



1461/C8B € 208,00 1 014610083  
240x210x50 mm 1,8 kg

### 1461/C8G

dispositivo de afinação para motores a diesel Ford/Mazda

Motores: 1.4-1.6-1.8-2.0-2.2 TDCi, 1.6D 8/16V, 1.8D, 1.8D Turbo, 1.8 TCi, 1.8 TDDi, 2.5D, 2.5D Turbo



1461/C8G € 360,00 1 014610084  
280x245x75 mm 2,2 kg

### 1461/C9B

dispositivo de afinação para motores a gasolina Opel

Motores: 1.0 12V, 1.0-1.2-1.4 16V



1461/C9B € 169,00 1 014610092  
335x145x60 mm 2 kg

### 1461/C10A

dispositivo de afinação para motores Audi, Seat, Skoda e Volkswagen

Motores: 1.9 - 2.0 TDI



1461/C10A € 152,00 1 014610101  
270x120x45 mm - 1,1 kg

### 1461/C10G

Temporizadores para motores Volkswagen/Audi/Seat e Skoda

Motores: 1.2-1.6-2.0 TDI CR (common rail)



1461/C10G € 507,00 1 014610103  
310x290x120 mm 2,8 kg

### 1461/C11A

dispositivo de afinação para motores Renault

Motores: 2.0 dCi



1461/C11A € 174,00 1 014610111  
420x280x60 mm - 1,2 kg



## 1461/C11G

dispositivo de afinação para motores Renault

Motores: 1.5-1.9-2.2-2.5 DCI



1461/C11G € 415,00 1 014610113  
310x290x120 mm 3,8 kg

## 1461/C12A

dispositivo de afinação para motores Fiat

Motores: 1.9-2.2 JTS e 1.9 JTD Euro 4



1461/C12A € 306,00 1 014610123  
280x245x75 mm - 1,8 kg

## 1461/C12G

Temporizadores para motores Fiat/Alfa/Lancia diesel

Motores: 1.9 JTD, 1.6-1.9-2.0 Multijet



1461/C12G € 273,00 1 014610124  
280x245x75 mm 2 kg

# Beta

## 1461/C13A

Temporizadores para motores turbo Fiat 0.9 Twinair



1461/C13A € 144,00 1 014610133  
240x210x50 mm 1,7 kg

## 1461/C13B

Temporizadores para motores Fiat 1.4 Multiair



1461/C13B € 221,00 1 014610134  
240x210x50 mm 2,8 kg

## 1461/C17B

dispositivo de afinação para motores a gasolina Volkswagen/Audi/Seat e Skoda

Motores: 1.2 TSI



1461/C17B € 123,00 1 014610171

## 1461/C18B

dispositivo de afinação para motores a gasolina Volkswagen/Audi/Seat e Skoda

Motores: 1.6-1.8-1.8T, 1.4-1.6-1.8-2.0 16V, 1.4-1.6-2.0 FSI



1461/C18B € 398,00 1 014610182  
310x290x120 mm 2,5 kg

## 1461/C20G

dispositivo de afinação para motores a diesel Fiat Iveco/Peugeot/Citroën/Ford

Motores: 2.2-2.3-3.0 Multijet



1461/C20G € 693,00 1 014610221  
385x290x100 mm 5,5 kg

## 1461/C21G

dispositivo de afinação para motores a diesel Renault

Motores: 1.6 dCi



1461/C21G € 409,00 1 014610222  
310x290x120 mm 3 kg

# Beta

# Beta



### 1461/C22B

dispositivo de afinação para motores a gasolina Peugeot/Citroën

Motores: 1.0-1.2 VTi



1461/C22B € 377,00 1 014610223

280x245x75 mm 2 kg

### 1461/C23B

dispositivo de afinação para motores a gasolina Opel

Motores: 1.0 - 1.2 - 1.4 ecoflex



1461/C23B € 491,00 1 014610224

280x245x75 mm 2,5 kg

### 1461/C24B

dispositivo de afinação para motores a gasolina Mini-Peugeot/Citroën

Motores: 1.4 - 1.6 (N12-N14)



1461/C24B € 611,00 1 014610225

280x245x75 mm 2,8 kg

### 1461/C25G

dispositivo de afinação para motores a diesel Mini

Motores: 1.6 diesel (W16D)



1461/C25G € 137,00 1 014610226

270x120x45 mm 1 kg

### 1461/C26B

dispositivo de afinação para motores a gasolina Fiat/Alfa Romeo/Lancia

Motores: 1.2-1.4 8v



1461/C26B € 338,00 1 014610227

280x245x75 mm 1,7 kg

### 1461/C27G

dispositivo de afinação para motores a diesel Bmw

Motores: 1.6-2.0D (N47-N47S)



1461/C27G € 246,00 1 014610228

280x245x75 mm 2 kg

### 1461/C28B

temporizadores para motores a gasolina Volkswagen, Seat e Skoda

motores 1.0 - 1.0 Bluemotion Tech  
1.0 Ecofuel/Ecomotive - 1.0 Green Tech



1461/C28B € 436,00 1 014610229

280x245x75 mm - 1,7 kg

### 1461/C29B

temporizadores para motores a gasolina Ford

motores 1.0 EcoBoost



1461/C29B € 627,00 1 014610209

280x245x75 mm - 2,6 kg

### 1461/C30G

temporizadores para motores a diesel Volkswagen/Audi/Seat e Skoda

motores 1.6-2.0 CR TDI  
para motores fabricados a partir de 2012



1461/C30G € 545,00 1 014610231

280x245x75 mm - 2 kg

## 1462CF/C6

Jogo de 6 chaves de caixa bi-sextavadas para injectores

Tamanhos:  
12-14-16-17-18-19 mm



1462CF/C6 € 84,00 1 014620006

260x145x60 mm - 1,2 kg

## 1462CF

Jogo de chaves de caixa bi-sextavadas para injectores



mm	€		
12	13,50	1	014620012
14	13,50	1	014620014
16	14,00	1	014620016
17	14,00	1	014620017
19	14,50	1	014620019
18	14,50	1	014620018

## 1462/KD

jogo ferramentas para remoção de injectores Denso, completo com martelo



1462/KD € 750,00 1 014620060

335x210x80 mm - 4,8 kg

## 1462/KI

Jogo de extractores de injectores common rail diesel

Permite a remoção de injectores DELPHI-BOSCH-SIEMENS-DENSO



1462/KI € 2.225,00 1 014620235

530x470x140 mm - 20 kg

## 1462/KMRC

jogo de ferramentas para remoção de injectores de motores Mercedes 2.1L, 2.2L, 3.0 V6 e Chrysler

Para injectores Bosch (2.1 e 2.2L) e Delphi (3.0)  
Permite a remoção de injectores sem extrair o motor.

Particularmente adequado para os seguintes modelos:  
Mercedes Vito, Vario, CLK, Sprinter, Viano, Classes M, GL, C, GLK, E, CLS, S, R, G  
Chrysler 300 C



1462/KMRC € 628,00 1 014620070

310x300x118 mm - 3,5 kg

## 1462/KU

jogo universal para remoção de injectores diesel common rail

Completo com alicate e martelo



1462/KU € 660,00 1 014620100

390x290x100 mm - 4,5 kg

## 1462AD/BSC

adaptador para remoção de injectores Bosch common rail

Para utilização com os artigos Beta 960KI e Beta 1462/KU



1462AD/BSC € 191,00 1 014620435

## 1462AD/SMN

jogo de adaptadores para remoção de injectores Siemens e Denso

Para utilização com o item Beta 960KI/1462KI



1462AD/SMN € 287,00 1 014620436

## 1462PIM

Placas para manutenção de injectores, par

As placas devem ser presas no torno secções:  
Ø 11-12-13-14-16-19-20 mm



1462PIM € 93,00 1 014620502

## 1463/KIT

kit de fixação da polia da árvore de cames



1463/KIT € 349,00 1 014630001

280x140x75 mm - 1,2 kg

## 1464T

Compressómetro digital

### ESPECIFICAÇÕES

- Ecrã touch 5"
- Bateria de lítio recarregável com sensor 80 bar (para baixa pressão) e cabo USB



1464T € 774,00 1 014640050

## 960AD/TP2

jogo de adaptadores para artigo 960TP em caixa plástica



960AD/TP2 € 459,00 1 009600510

≡ 430x310x50 mm - 3,2 kg

## 1464AP

Kit para teste do sistema de alta pressão em motores common rail diesel, com artigo 1464T

### Equipado com:

- jogo mangueiras de alta pressão
- uniões
- sensor 2,000 bar



1464AP € 697,00 1 014640450

≡ 430x310x50 mm - 1,8 kg

## 1464APB

Kit para teste do sistema de alta pressão em motores diesel FSI petrol, com artigo 1464T

Equipado com sensor 200 bar e conectores



1464APB € 344,00 1 014640500

≡ 240x210x50 mm - 0,5

## 1464FG

jogo de reguladores falsos para inspeção de sistema common rail diesel (utilização com item Beta 1464T-1464AP)

Utilizado com os adaptadores e dispositivo de teste adequados, possibilita determinar se o problema se encontra na bomba de alta pressão ou no regulador quando não existe pressão no circuito em motores common rail. Recomendado para reguladores de pressão Bosch, Delphi, Denso e Siemens.



1464FG € 269,00 1 014640470

≡ 350x250x80 mm - 1,8

## 1464IC

Jogo de adaptadores para artigo 1464T

Permite a ligação ao motor para verificar a compressão em motores diesel com o aparelho de teste digital 1464T.



### Conteúdo:

- 22 velas de incandescência falsas
- 5 injectores falsos
- 1 injector falso universal para pesados, motores de embarcações e máquinas agrícolas

1464IC € 513,00 1 014640350

≡ 559x312x50 mm - 4,5 kg

## 1464PB

jogo de 9 conectores para teste de baixa pressão de combustível (utilização com item 1464T)

Conectores rápidos para dispositivo de teste 1464T para rápida verificação da baixa pressão do combustível em motores a gasolina e a diesel.



1464PB € 471,00 1 014640700

≡ 530x440x120 mm - 3,8 kg

## 1464PF

Kit para testar pressão da bomba de travões, com artigo 1464T

Equipado com adaptadores e conectores



1464PF € 620,00 1 014640650

≡ 400x280x60 mm - 3 kg



## 1464PT

Kit para teste da pressão do turbo, com artigo 1464T

Equipado com sensor e cabo de ligação



1464PT € 150,00 1 014640550

240x210x50 mm - 380 g

## 1464TDI

Kit para teste da bomba de pressão em motores TDI, com artigo 1464T

Equipado com conector



1464TDI € 106,50 1 014640600

240x210x50 mm - 400 g

## 1466/C5

Kit de 5 chaves para extração de líquido de travões

Contém:  
• 5 chaves tamanhos 7-8-9-10-11 mm  
• 1 tubo de drenagem com válvula de retenção



1466/C5 € 112,00 1 014660100

260x170x50 mm - 600 g

## 1467

extractor de líquido de travões



Pressão: min 5 bar, max 11.5 bar

1467 1,5 € 300,00 1 014670001

## 1467/RK1

kit de substituição de tubo para artigo 1467



1467/RK1 € 22,40 1 014670501

## 1467/RK2

filtro de substituição para artigo 1467



1467/RK2 € 86,50 1 014670502

## 1467LF

aparelho electrónico para substituição do líquido dos travões

Com "efeito pulsante"



- Para automaticamente quando o depósito está vazio, evitando a entrada de ar
  - Volume máximo do depósito: 20 l
  - Pressão de trabalho: 0.4+3.5 bar
  - Alimentação: 230V
- Fornecido com:
- Depósito de recolha do líquido de travões
  - 1 adaptador universal + 1 adaptador standard E20

1467LF € 1.790,00 1 014670100

## 1467LF/RC

recipiente com tubo de recuperação de líquido de travões para artigo 1467LF



1467LF RC € 87,50 1 014670125

## 1468N

depressores de válvulas para a remoção do disco

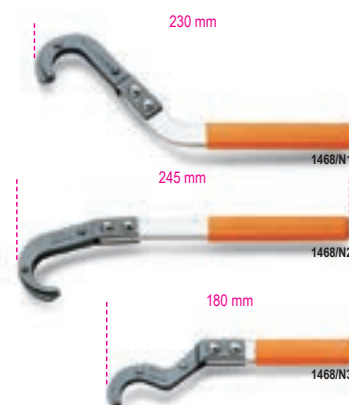

1468N/1	€ 21,30	1	014680011
1468N/2	€ 21,80	1	014680012
1468N/3	€ 22,40	1	014680013

## 1470

alicate para as molas dos travões de tambor



L mm	€		
210	35,00	1	014700001
330	46,00	1	014700002
540	138,00	1	014700010

## 1470FT

Alicate para as molas dos travões de tambor

Pontas em ângulo de 40°  
Acesso fácil a espaços exíguos

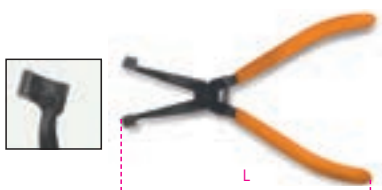

L mm	€		
184	37,50	1	014700000

## 1471

alicate para as molas dos travões de tambor



L mm	€		
330	69,00	1	014710001

## 1471A

alicate para cabos de travões de mão



A max mm	B mm	€		
45	5	84,00	2	014710010

## 1471M/C22

ferramenta pneumática para rodar e recuar os êmbolos de travões direitos e esquerdos, com acessórios



1471M/C22	€		
	270,00	1	014710101

350x310x85 mm - 3,5 kg

## 1471M/50

ferramenta pneumática para rodar e recuar os êmbolos de travões direitos e esquerdos, com acessórios

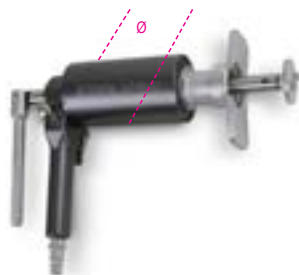

∅ mm	Kg	Bar	€		
50	150	5÷8	151,00	1	014710069

## 1471M/P

Adaptador de calços e pinças de travão TRW-Mégane



1471M/P	€		
	22,90	1	014710080

## 1471M/W50

adaptador de travão de mão VW Passat (posterior a 2005)

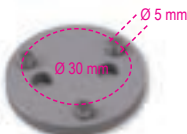

1471M/W50	€		
	8,10	1	014710079

## 1471PN/B1

adaptador de travão de mão Ford

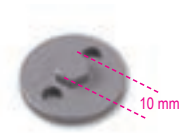

1471PN/B1	€		
	8,00	1	014710081

## 1471PN/B2

adaptador de travão Daily



1471PN/B2	€		
	11,20	1	014710082

## 1471PN/B3

adaptador de travão de mão BMW

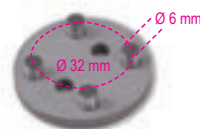

1471PN/B3	€		
	8,00	1	014710083

## 1471PN/B4

adaptador de travão de mão BMW

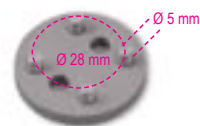

1471PN/B4	€		
	8,00	1	014710084

## 1471PN/B5

adaptador de travão de mão BMW/Mini



1471PN/B5	€		
	6,90	1	014710085

## 1471CF

chave de caixa pentagonal para aperto de porcas de pinças de travões



mm	€		
14	15,30	1	014710314
19	15,30	1	014710319

## 1471CM

chave de caixa pentagonal para aperto de parafusos de pinças de travões



mm	€		
10	15,30	1	014710360

## 1471CM/E11

Chave de caixa sextavada, 11 mm, para parafusos das pinças de travão Mercedes ML (série 166)



mm	∅ mm	L mm	L1 mm	€	🔧	📦
11	24	75	15,5	16,40	1	014710361

## 1471D2

ferramenta para recuar êmbolos dos discos de travões, com pinças fechadas  
Dois pares de placas para trabalhar com 2 e 4 pinças



∅ mm	€	🔧	📦
10	69,50	1	014710301

250x170x60 mm 1,5 kg

## 1472

alicate para abraçadeiras



1472	€	🔧	📦
	40,00	1	014720001

## 1472AU

alicate para abraçadeiras



∅ mm	€	🔧	📦
18+53	117,00	1	014720100

## 1472R/AU

pontas de substituição para alicate 1472AU



1472AU/R	€	🔧	📦
	44,50	1	014720101

## 1472AU/P

alicate com extensão para abraçadeiras de fecho automático



∅ mm	L mm	€	🔧	📦
18+54	630	101,50	1	014720105

## 1472AU/RP

cabo de substituição para alicate 1472AU/P



1472AUP/R	€	🔧	📦
	24,60	1	014720106

## 1472FC

alicate para abraçadeiras Clic(R) com cabeça rotativa



1472FC	€	🔧	📦
	36,00	1	014720090

## 1472FC/GE

alicate para abraçadeiras clic®

Particularmente adequado para abraçadeiras grandes dimensões



L mm	€	🔧	📦
230	63,50	1	014720093

## 1472FC/L

alicate para abraçadeiras Clic® com extensão flexível



L mm	€	🔧	📦
630 mm	98,50	1	014720095

## 1472FCL/RP

cabo de substituição para alicate 1472FC/L



1472FCL/RP	€	🔧	📦
	43,50	1	014720096

## 1472FCA

Alicate para abraçadeiras tipo Visa®



1472FCA	€	🔧	📦
	55,50	1	014720041

## 1472H

ferramenta para remover abraçadeiras Henn



L mm	€	🔧	📦
100	21,30	1	014720000

## 1472TM

alicate para abraçadeiras de filtros multijet



1472TM	€	🔧	📦
	25,00	1	014720200

### 1472VW

alicate para abraçadeiras, com cabeça rotativa  
Para viaturas Volkswagen e Mercedes



1472VW € 41,50 1 014720051

### 1473

alicate para abraçadeiras OETIKER®



1473 275 € 113,00 1 014730001

### 1473A

alicate para abraçadeiras OETIKER®



1473A € 86,50 1 014730010

### 1473Q

Alicate para abraçadeiras OETIKER®

Para utilização com:  
• chaves dinamométricas  
• roquetes  
• quadras macho

3/8"



1473Q € 80,50 1 014730005

# Beta

### 1473P

alicate para abraçadeiras OETIKER® de baixo perfil



1473P A Max mm 53 € 31,00 1 014730020

### 1473FN

alicate para abraçadeiras em aço inox

Para abraçadeiras Panduit(R) e similares



1473FN A mm 4,7÷9,5 € 59,00 1 014730501

### 1473T

Alicate para abraçadeiras em aço

Permite cortar as abraçadeiras sem o risco de causar danos em resguardos, mangas, etc.



1473T A Max mm 14 L mm 220 € 53,00 1 014730582

### 1474/C4

kit de 4 ferramentas para remoção de bobinas em velas de ignição Volkswagen



1474/C4 € 89,50 1 014740100

290x190x50 mm - 1 kg

### 1474E/VW

extractor de bobinas de ignição, grupo Volkswagen



1474E/VW € 24,00 1 014740120

### 1474L

alicate para cachimbos de velas com bicos longos curvos a 15°

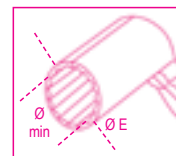

1474L Ø min mm 14 Ø E mm 20 € 72,00 2 014740010

### 1474DL

alicates longos para cachimbos de velas com punhos de dupla camada em PVC



1474DL € 34,00 1 014740015

### 1474G

Alicate para remover cachimbos de velas de incandescência



1474G € 39,50 1 014740200

## 1475U

alicate universal cromado brilhante com punho em forma de pistola e dupla camada em PVC

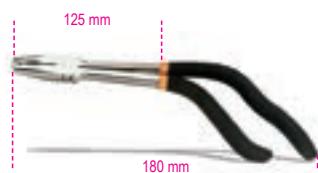

1475U € 36,00 1 014750010

## 1476

alicate de pressão com corrente para o corte de tubos de escape

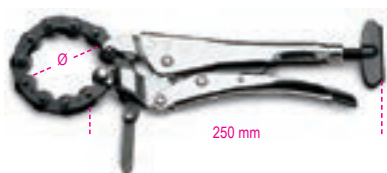

Ø min mm 19 Ø max mm 75 € 113,00 1 014760001

## 1476/RC

corrente de substituição para ref. 1476



1476RC € 88,50 1 014760010

## 1476A

alicate com corrente para o corte de tubos de escape



Ø min mm 30 Ø max mm 95 € 89,50 1 014760005

## 1476A/RC

corrente de substituição para ref. 1476A



1476A/RC € 77,50 1 014760015

# Beta

## 1476C/1

expansor de tubos de escape



1476C/1 € 34,00 1 014760101  
Ø 30÷42 mm  
L = 131 mm  
L1 = 51 mm

## 1476GT

alicate para remoção dos apoios em borracha dos tubos de escape



L mm 280 A Max mm 58 ± mm 3 € 31,00 1 014760050

## 1476PSA

alicate para abraçadeiras com pino do circuito de escape, grupo PSA

A forma da ponta e o bloqueio automático da cremalheira possibilitam trabalhar sem extrair o pino



L mm 309 A Max mm 60 S mm 12,2 € 37,50 1 014760060

## 1476T

Chave para remoção/instalação de turbinas em motores Volkswagen Audi a diesel

Acesso fácil e rápido à porca sob a turbina



mm 12 € 34,00 1 014760200

## 1477/C10

chave de aperto com 9 bits para porcas das polias de correias

1 chave de aperto  
4 bits bisextavados: 12x14 - 13x15 - 16x17 - 18x19 mm  
5 bits para parafusos Torx®: E10 - E12 - E14 - E16 - E18



1477/C10 € 147,00 1 014770310  
530x110x55 mm

## 1477D

chave para aperto de porcas das polias de correias



mm 13 € 25,50 1 014770113  
15 € 25,50 1 014770115  
16 € 25,50 1 014770116  
17 € 25,50 1 014770117  
19 € 25,50 1 014770119

## 1477D/S5

jogo 5 chaves de luneta para porcas de aperto



1477D/S5 € 129,00 1 014770200  
13-15-16-17-19 mm  
600x200x70 mm - 2,2 kg

## 1477K/7

kit com chave de roquete reversível curva e pontas



- 2 pontas TORX T40-T45  
- 1 ponta XZN  
- 1 ponta hexagonal, 8 mm  
- 3 pontas bi-hexagonais, 10-12-13 mm

L mm 250 € 130,00 1 014770051



### 1478

alicate para cavilhas



1478 € 51,50 1 014780001

### 1478T

alicate remoção de pinos em plástico com cabeça rotativa e clips de pressão

Cabeça rotativa a 90°

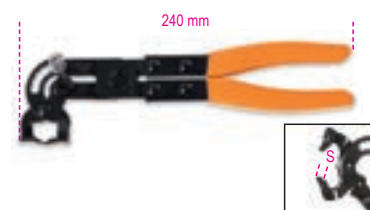

1478T € 40,00 1 014780101

### 1478/3P

Alicate para remoção de pinos plásticos, com 3 pontos de contacto



1478/3P € 56,50 1 014780151

### 1479

extractor de cavilhas



1479 € 21,20 2 014790001



### 1479/B27

kit 27 ferramentas de nylon para remoção de pinos e trabalhos em plásticos e vedantes, com possibilidade de suspensão



1479/B27 € 69,50 1 014790407

### 1479L/S2

Barra de desmontagem, par, Teflon®



1479L/S2 € 32,50 1 014790510

### 1479N/S5

kit de 5 extractores de cavilhas de nylon



1479N/S5 € 36,00 1 014790251

### 1479RB/1

raspador direito



1479RB/1 € 24,60 1 014790315

### 1479RB/2

raspador curvo



1479RB/2 € 24,60 1 014790320

### 1479RB/3

raspador espalmado



1479RB/3 € 28,00 1 014790310

### 1479U/13

extractor de cavilhas, lâmina em aço inoxidável



1479U/13 € 22,40 2 014790010

### 1479U/32

extractor de cavilhas, lâmina em aço inoxidável



1479U/32 € 26,00 2 014790015

### 1480

Kit para enchimento de filtros de óleo diesel sem recurso a bombas eléctricas

• Também para utilização com punhos de encher pneus

Conteúdo:

- uniões rápidas GM
- uniões rápidas Renault, GM, Fiat, Ø interno 6 mm
- uniões rápidas Renault, GM, Fiat, Ø interno 7 mm
- uniões rápidas Ford
- uniões rápidas PSA, Ø interno 6 mm
- uniões rápidas PSA, Ø interno 7 mm
- uniões rápidas Ford
- 2 adaptadores cónicos para veículos sem uniões rápidas



1480 € 338,00 1 014800010

410x320x70 mm

## 1481/C12

Kit de 6 pares de grampos para oclusão de tubos

Contém:

- 2 pares de grampos 1/4"
- 2 pares de grampos 3/8"
- 2 pares de grampos 5/16"
- 3 pares de tampas de borracha



1481/C12 € 108,00 1 014810312

370x270x59 mm

## 1481PL/A

grampos para oclusão de tubos

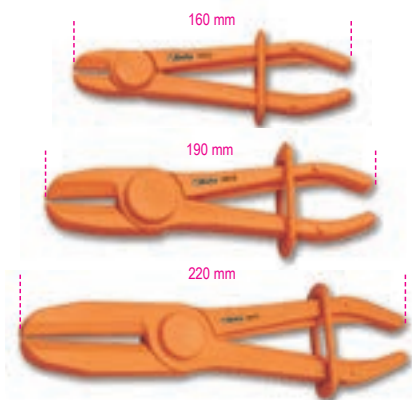

	∅ mm	€		
1481PL/A	8÷15	17,50	3	014810110
1481PL/B	15÷25	19,70	3	014810120
1481PL/C	25÷45	27,00	3	014810130

## 1481PL/S3

jogo de 3 grampos para oclusão de tubos

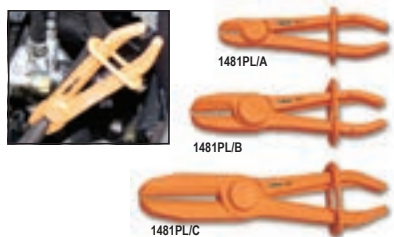

1481PL/S3 € 64,00 1 014810200

1481PL-A ∅ 8÷15 mm  
1481PL-B ∅ 15÷25 mm  
1481PL-C ∅ 25÷45 mm

## 1482

chave para tampas de depósitos de combustível

chave regulável para montagem/desmontagem das tampas dos depósitos de combustível



∅ mm 89÷170 € 98,50 1 014820001

## 1482A/1

chave de três pernas para tampas de depósitos de combustível em alumínio

Para porcas de anel em alumínio instaladas em automóveis Fiat, Volkswagen, Opel, Chevrolet, Mercedes e BMW a partir de 2011



∅ mm 185 € 69,00 1 014820005

## 1482A/2

chave para tampas de depósitos de combustível, 12 estrias

Para porcas de anel sem ranhuras laterais, instaladas em automóveis e carrinhas Fiat e Ford

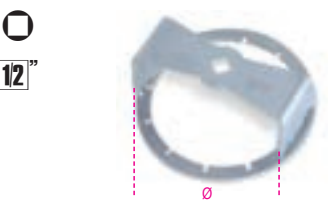

∅ mm 132 € 63,00 1 014820006

## 1482A/3

chave para tampas de depósitos de combustível, grupo PSA

Concebida para possibilitar o trabalho em eixos descentralizados, removendo a tampa sem danificar a linha de combustível



∅ mm 157 € 78,50 1 014820007

## 1482A/4

Chave para tampas de depósitos de combustível, 5 dentes

Para utilização em automóveis do grupo FCA, incluindo Freemont, 500L, 500X, Renegade...



∅ mm 145 € 82,00 1 014820014

## 1482A/5

Chave para tampas de depósitos de combustível, 22 setores

Para utilização em tampas de plástico de automóveis do grupo VAG



∅ mm 180 € 60,00 1 014820015

## 1482/8 - 1482/10

alicates para ligações rápidas de tubos de combustível

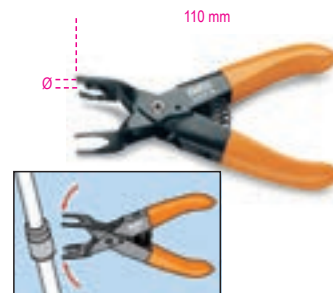

	∅ mm	€		
1482/8	8	34,50	2	014820008
1482/10	10	34,50	2	014820010

## 1482B

alicate para ligações rápidas de tubos de combustível



1482B € 40,00 1 014820021

## 1482C

adaptadores (2 pares) para remoção de uniões de filtros diesel, para os grupos Fiat, Volkswagen, Jeep, Chrysler e Volvo

Rápida substituição do filtro sem danos irreparáveis nas uniões



1482C € 55,50 1 014820022

## 1483K/12

kit para remoção de válvulas de sistemas de ar condicionado com jogo de bits cabeça em estrela

O kit inclui:

- 2 chaves de caixa fêmea octogonais, Ø 12 e 15 mm, para válvulas de alta pressão
- 2 chaves de caixa macho abertas, secção 2.2 e 3.2 mm, para válvulas "borboleta"
- 1 jogo bits cabeça de estrela, tamanhos: PT10, PT15, PT20, PT25, PT27, PT30, PT40



1/4"



1483K/12 € 36,00 1 014830012

120x80x35 mm

## 1483KV-PT/S7

jogo de bits cabeça em estrela

Tamanhos incluídos:

PT10 - PT15 - PT20 - PT25 - PT27 - PT30 - PT40



1/4"



1483KV PT/S7 € 9,85 1 014830117

## 1483K/22

Kit separação de uniões em sistemas de ar condicionado, fornecimento de combustível e lubrificação



1483K/22 € 123,00 1 014830022

300x230x55 mm - 1 kg

## 1484

Jogo 2 ferramentas para remoção e instalação de cintas elásticas

Remoção rápida e instalação correcta de cintas elásticas sem danos



1484 € 109,00 1 014840010

## 1485BP

Chave meia-lua para polias dentadas

Podem ser ajustada através do punho (veio roscado), aperta e bloqueia a polia de fora, evitando que os sensores vizinhos fiquem danificados



A Max mm € 196,00 1 014850000

## 1485BPM

chave meia-lua em alumínio para polias dentadas

Podem ser ajustada através do punho giratório; aperta e bloqueia a polia a partir de fora, evitando danos nos sensores vizinhos



A Max mm € 168,00 1 014850002

## 1485FCA/K2

ferramentas para pré-carregamento dos rolamentos da correia de distribuição, grupo FcA (par)

Recomendadas para motores 1.2, 1.4 8/16 V e 1.4 Multiair

- 1 ferramenta 175 mm comprimento com hastes de 13.5 mm profundidade
- 1 ferramenta articulada 305 mm comprimento com hastes de 13.5 mm profundidade



1485FCA/K2 € 90,00 1 014850220

## 1485FCA/T

Tensionador de correia, série longa, com inserts de 13.5 mm



L mm P mm € 33,00 1 014850210

## 1485FCA/TS

Tensionador de correia, articulado, com inserts 13.5 mm inserts



L mm P mm € 57,50 1 014850215

## 1485FRD/T

alavanca para tensionamento de correias em motores Ford

Podem ser utilizada para remover polias de alternador



L mm Q mm € 70,00 1 014850310

## 1485/KIT

kit para controlar a tensão da correia de distribuição



1485/KIT € 159,00 1 014850100

230x140x75 mm - 580 g

## 1485MJ

Chave de bloqueio de árvore de cames, para motores 1.3 16V Multijet

2 cabeças de 3 formas para trabalhar em todos os motores Multijet 1.3 16 do grupo de veículos FCA, Opel, Ford e Suzuki

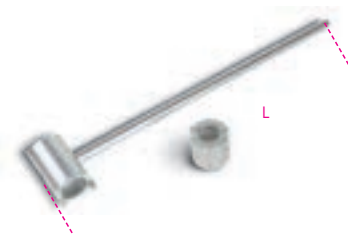

L mm € 109,00 1 014850150

### 1485MTJ/1.3

ferramenta de bloqueio para polia da correia de distribuição para motores 1.3 Multijet

5 pinos de verificação de precisão permitem realizar trabalhos na correia com total segurança



1485MTJ/1.3 € 78,00 1 014850160

### 1485PMTJ

alavanca para desmontagem da polia para motores Multijet

Para bloquear o eixo durante a remoção da polia



L mm 450 € 113,00 1 014850190

### 1485R

ferramenta universal para rodar polias da árvore de cames em ferro fundido com 2 pares de ponteiras



Ø mm 30=120 Ø1 mm 10 - 17 L mm 500 € 139,00 1 014850025

### 1485R/P10

par de pernos



1485R/P10 € 14,20 1 014850035

### 1485R/P17

par de pernos



1485R/P17 € 14,20 1 014850038

### 1485VAG/K2

Chaves para os tensores das correias de distribuição, par

- Cabeça giratória em 3 posições
- 1 ferramenta com cabeça de 12,5 mm de profundidade
- 1 ferramenta com cabeça de 21,5 mm de profundidade



1485VAG/K2 € 66,50 1 014850080

### 1485VAG

chaves para tensores de correias de distribuição

cabeça giratória em 3 posições



	L mm	P mm	€		
1485VAG/12,5	190	12,5	34,50	1	014850062
1485VAG/21,5	195	21,5	32,50	1	014850071

### 1486/10

chave para válvulas cilíndricas de gás natural

- veículos do grupo VW a partir de 2008
- Panda de 2004 a 2012
- Grande Punto de 2005 a 2012
- Ducato a partir de 2010
- novos Doblò e Combo
- Cubo e Fiorino



36 mm

1486/10 € 125,00 1 014860110

### 1486/20

chave para válvulas cilíndricas de gás natural

- Multipla
- Ducato 1ª e 2ª série até 2010
- Berlingo e Ranch
- C3 com cilindros em ferro
- Punto de 1999 a 2010
- Doblò 1ª série
- grupo Daily e Iveco
- Dr5



36 mm

1486/20 € 125,00 1 014860120

### 1486/30

chave para válvulas cilíndricas de gás natural

- Zafira 2ª série
- Combo 1ª série

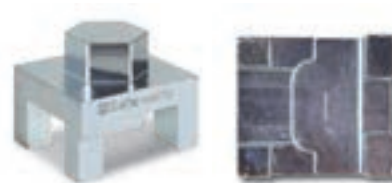

36 mm

1486/30 € 125,00 1 014860130

### 1486/40

chave para válvulas cilíndricas de gás natural

- Touran 1ª série

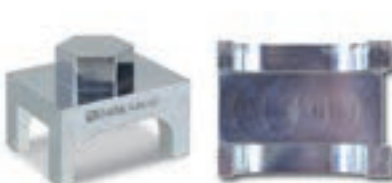

36 mm

1486/40 € 125,00 1 014860140

### 1486/50

chave para válvulas cilíndricas de gás natural

- Panda a partir de 2012
- Novo Ypsilon



36 mm

1486/50 € 125,00 1 014860150



## 1486/60

chave para válvulas cilíndricas de gás natural

- C4 Picasso
- sistemas BRC



□ 36 mm

1486/60 € 125,00 1 014860160

## 1486/70

chaves para válvulas cilíndricas de gás natural, par

- C3 com cilindros compostos

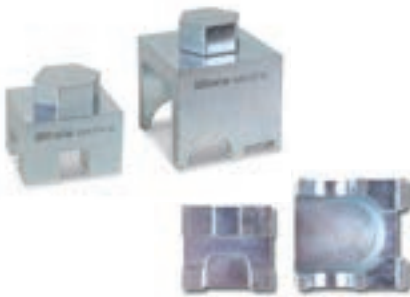

□ 36 mm

1486/70 € 260,00 1 014860170

## 1486/80

chave para válvulas cilíndricas de gás natural

- Classe B
- Zafira 3ª série

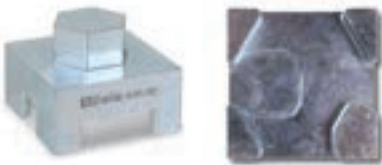

□ 36 mm

1486/80 € 125,00 1 014860180

## 1486/90

chave para válvulas cilíndricas de gás natural

- Zafira 1ª série
- Kangoo 1ª série
- Sprinter



□ 36 mm

1486/90 € 125,00 1 014860190

## 1488 - 1488L

chave articulada com corrente para filtros de óleo



	∅ mm	€		
1488	60÷110	82,00	1	014880001
1488L	60÷160	90,00	1	014880050

## 1488/1

chave articulada com corrente para filtros de óleo



	∅ mm	€		
1488/1	60÷110	95,50	1	014880010

## 1488R...

corrente de substituição



		€		
1488RC	1488	33,50	1	014880101
1488RL	1488/L	53,50	1	014880150
1488RC/1	1488/1	48,00	1	014880110

## 1489/31T

chave para polia de alternador



	T50	∅	mm	€		
1489/31T	15	31	34,50	1	014890016	

## 1489/33

chave para polias de alternadores Bosh



	mm	€		
1489/33	33	13,70	1	014890010

## 1489/33P

chave para polias de alternador, para os novos alternadores Bosch FIAT Grande Punto



	M	∅ mm	mm	€		
1489/33P	10	15	31	43,50	1	014890015

## 1489/E

chave para polia de alternador

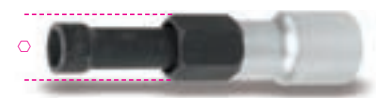

	∅ mm	∅ mm	€		
1489/E	10	15	29,50	1	014890025

## 1489R

chave para polias de alternador



	€		
1489R	14,20	1	014890020

## 1489/Y

chave para polias de alternador, para alternadores Nippondenso



	∅ mm	€		
1489/Y	32	16,40	1	014890040

## 1489/C14

jogo de 14 ferramentas universais para polias do alternador



	€		
1489/C14	257,00	1	014890100

867PE	8 mm
867PE/L	8 mm
867XZN/L	M10
867TX/L	T50
867/2	□1/2"
920B	10 mm
1489/33	
1489/33P	M10
1489R	
1489/Y	
1489/31T	T50
1489/E	10 mm
188	10 mm
188	15 mm

420x250x45 mm - 1,9 kg

## 1490

chaves de correia para filtros de óleo

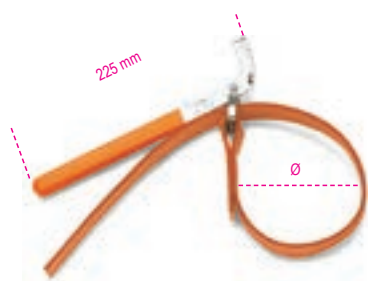

	Ø max mm	€		
1490/1	160	33,00	1	014900001
1490/2	240	35,00	1	014900002

## 1490/R1 - 1490/R2

faixas de tecido sobresselentes para artigo 1490



	Ø mm	€		
1490R/1	160	15,30	1	014900101
1490R/2	240	18,60	1	014900102

## 1491

chave para filtros de óleo com cinta metálica regulável



	Ø mm	€		
1491	65÷110	42,00	2	014910001

## 1491R

cinta metálica de substituição para ref. 1491



	€		
1491R	7,55	10	014910010

## 1491C

alicates ajustáveis para filtros de óleo



	Ø mm	L mm	€		
1491C	60÷100	300	27,00	1	014910030

## 1492/1 - 1492/2

chaves reguláveis para filtros de óleo

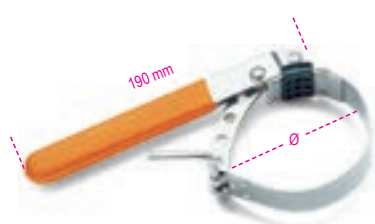

	Ø mm	€		
1492/1	60÷80	40,50	1	014920001
1492/2	80÷110	42,00	1	014920002

## 1492T

chave para filtros de óleo



	Ø mm	H mm	€		
1492T 40	125÷145	40	31,50	1	014920540
1492T 75	120÷140	75	53,50	1	014920575

## 1493B

kit chaves bi-sextavadas para filtros de óleo



mm	mm	€		
24	8	16,90	1	014930524
27	8	17,50	1	014930527
32	8	18,00	1	014930532
36	8	19,10	1	014930536
38	8	19,70	1	014930538

## 1493B/S5

Kit de 5 chaves bi-sextavadas para filtros de óleo

tamanhos: 24-27-32-36-38 mm



	€		
1493B/S5	71,00	1	014930599

## 1493

chave para filtros de óleo



Ø mm	N	€		
65	14	9,40	1	014930200
68	14	9,40	1	014930206
73	14	9,40	1	014930208
74	14	9,40	1	014930209
74	15	9,40	1	014930210
75-77	15	9,40	1	014930212
76	8	9,40	1	014930214
76	14	9,40	1	014930218
76-74	15	9,85	1	014930220
78	15	9,85	1	014930224
80	15	10,40	1	014930226
82-80	15	10,40	1	014930228
86	16	10,90	1	014930230
90	15	10,90	1	014930234
92	10	10,90	1	014930236
93	15	10,90	1	014930238
95	15	10,90	1	014930244
100	15	12,60	1	014930248
106	15	13,10	1	014930250
108	15	13,10	1	014930252
135	18	21,30	1	014930256

## 1493/PF

chaves filtro de óleo Purflux®



Ø mm	N	€		
66	6	9,40	1	014930202
76	12	9,40	1	014930216
76	30	9,85	1	014930222
86	18	10,90	1	014930232
93	36	10,90	1	014930240
93	45	10,90	1	014930242
96	9	33,00	1	014930070
96	18	10,90	1	014930246
108	18	14,20	1	014930254

# Beta

## 1493/C30

jogo de 28 chaves para filtros de óleo

12"



Tamanhos incluídos no jogo (Ø mm / n°. de lados)

1493:

65/14 - 67/14 - 68/14 - 73/14 - 74/15  
76/15 - 75.77/15 - 76/14 - 76/8 - 78/15 - 80/15  
82/15 - 86/16 - 90/15 - 92/10 - 93/15 - 95/15  
100/15 - 106/15 - 108/15

1493PF (Purflux)

66/6 - 76/12 - 76/30 - 86/18  
93/36 - 93/45 - 96/18 - 108/18

- Inclui 1 chave ajustável de filtros de óleo  
Ø 65÷120 mm

1493/C30 € 236,00 1 014930000

530x400x110 mm - 4 kg

## 1493AL

chaves de filtro

N= número de lados

38"

12"



Ø mm	N	•	€	1	014930310
64	14	27	13,70	1	014930310
66,5	14	27	12,00	1	014930315
74	14	27	14,80	1	014930320
79	15	27	13,70	1	014930325
84	14	27	14,80	1	014930330
87	16	27	18,60	1	014930335
92	15	27	15,30	1	014930340
94,5	15	27	15,30	1	014930345
100,5	15	27	15,30	1	014930350

## 1493AL 4S

chaves de filtro  
para veículos de origem asiática  
perfil de 4 ganchos

38"

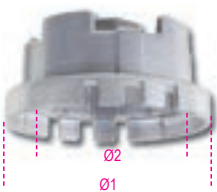

Ø1 mm	Ø2 mm	N	€	1	014930304
70	64,5	27	14,80	1	014930304
80	64,5	27	13,70	1	014930305

## 1493AL CF

chaves de caixa sextavadas  
para cartuchos de filtro

12"



Ø mm	H mm	•	€	1	014930424
24	34	27	8,75	1	014930424
27	34	27	8,75	1	014930427
30	34	27	8,75	1	014930430
32,5	34	27	9,30	1	014930432
36	34	27	9,30	1	014930436
38	34	27	9,30	1	014930438

## 1493/C19

jogo 18 chaves de filtro de óleo,  
particularmente adequadas para automóveis  
de origem asiática

Ø mm	N°. de lados
63-64	14
66.5	14
74	14
79	15
84	14
87	16
92	15
94.5	15
100.5	15
64.5	14 chave de gancho para veículos Toyota
64.5	14 chave de gancho para veículos Lexus
6 chaves de caixa sextavadas, tamanhos 24-27-30-32.5-36-38 mm, para cartuchos de filtro	
Kit inclui 1 chave universal ajustável Ø 58÷93 mm	

12"

38"



1493/C19 € 208,00 1 014930019

490x450x60 mm - 4 kg

## 1493DSG

chave para filtros de óleo DSG

12"



mm

24

€ 33,00 1 014930800

## 1493FF

chave para remover/installar o alojamento em  
plástico  
dos filtros de óleo dos motores Ford Peugeot  
Citroën: TDCi-HDi

Permite o aperto correcto do alojamento em plástico a 25 Nm  
com chave dinamométrica



12"



mm

27

€ 26,00 1 014930127

## 1493FT

chave para filtros de óleo Ford Transit Diesel

Pode ser utilizada para todas as versões  
Transit, Transit Custom e Tourneo Custom  
fabricadas desde 2012

12"



Ø mm

115

€ 22,40 1 014930085

## 1493/C7

chave de filtros de regulação automática  
com três braços cambiáveis, para aperto à  
esquerda e à direita

Revestimento diamantado anti-derrapante

2 jogos de braços:

- 1 jogo com 20 mm comprimento de trabalho
- 1 jogo com 38 mm comprimento de trabalho

38"



Ø mm

1493/C7

50÷100 16

€ 101,00 1 014930079

210x150x50 mm



## 1493/S-U

chave de ajuste automático para filtros de óleo com 3 braços, para aperto manual direito e esquerdo

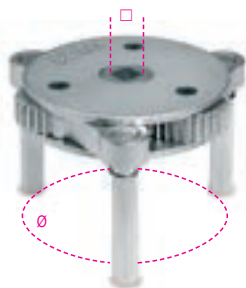

	□	∅ mm	€	🔧	📦
1493/S	3/8-1/2	80-115	75,50	1	014930074
1493/U	1/2	105-165	166,00	1	014930076

## 1493T

chave de regulação automática para filtros de óleo, também para aperto à esquerda



∅ mm	€	🔧	📦
60÷120	27,50	1	014930075

## 1493J

chaves para filtros de óleo MultiJet

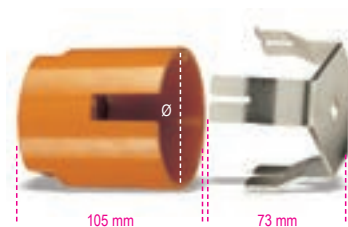

∅ mm	€	🔧	📦
90	106,00	1	014930080

## 1493X

chaves de filtro com bloqueio automático, para aperto à esquerda



	∅ mm	± mm	€	🔧	📦
1493X/1	60÷80	2,9	27,50	1	014930105
1493X/2	80÷98	2,9	27,50	1	014930110

## 1493Y

chaves de filtro com bloqueio automático, para aperto à esquerda e à direita, versão para trabalhos pesados

Item 1493Y/2 também pode ser utilizado para filtros de secado



	∅ mm	± mm	€	🔧	📦
1493Y/1	80÷110	7,3	97,50	1	014930120
1493Y/2	104÷145	7,3	149,00	1	014930122

## 1494

chave quadra para bujões de óleo



mm	€	🔧	📦
10	7,65	1	014940280

## 1494E

chave macho hexagonal para bujões de óleo



mm	€	🔧	📦
8	7,65	1	014940208
9	7,65	1	014940209
10	7,65	1	014940210
11	7,65	1	014940211
12	7,65	1	014940212
14	7,65	1	014940214
17	7,65	1	014940217

## 1494Q

chave macho quadra para bujões de óleo



mm	€	🔧	📦
8	7,65	1	014940258
9,5	7,65	1	014940259
12	7,65	1	014940262
13	7,65	1	014940263

## 1494T

chave macho triangular para bujões



mm	€	🔧	📦
9,5	7,65	1	014940289

## 1494XZN

chave macho perfil XZN® para bujões de óleo

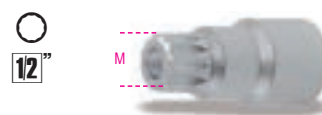

M	€	🔧	📦
16	9,30	1	014940296

## 1494VW

chave especial para bujões do cárter, motores Volkswagen

Permite remover e instalar o bujão em plástico do cárter de óleo.

Especialmente desenvolvido para veículos Volkswagen com motor TFSI e TDI



	€	🔧	📦
1494VW	19,70	1	014940305

## 1494/C14A

jogo de 14 ferramentas para muda de óleo



	€	🔧	📦
1494/C14A	117,00	1	014940150

- 1494E 8-9-10-11-12-14-17
- 1494Q 8-9,5(3/8")-12-13
- 1494 10
- △ 1494T 9,5(3/8")
- 1494XZN M16

📏 380x305x40 mm - 📖 1,7 kg

## 1494M

chave magnética e flexível para bujões sextavados

Permite remover bujões sem risco de queimaduras para o operador

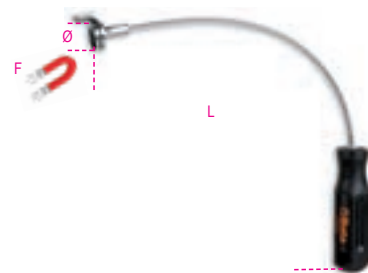

L mm	F kg	∅ mm	€	🔧	📦
293	2,5	19	20,80	1	014940401



## 1495/C6

jogo de ferramentas para reparação de roscas de bujões de óleo



• A rosca danificada é removida por um macho e aumentada uma medida

• Permite reparar e evitar a substituição do cárter de óleo

Conteúdo:

- 1 macho M13x1.25 + 6 parafusos + 12 anilhas
- 1 macho M13x1.5 + 6 parafusos + 12 anilhas
- 1 macho M15x1.5 + 6 parafusos + 12 anilhas
- 1 macho M17x1.5 + 6 parafusos + 12 anilhas
- 1 macho M20x1.5 + 6 parafusos + 12 anilhas
- 1 macho M22x1.5 + 6 parafusos + 12 anilhas

1495/C6	€ 247,00	1	014950500
---------	----------	---	-----------

420x185x60 mm - 2,1 kg

## 1495M

macho para roscas de bujon



M	€	1	014950553
13x1,25	14,80	1	014950553
13x1,50	12,00	1	014950563
15x1,50	13,10	1	014950565
17x1,50	14,80	1	014950567
20x1,50	16,40	1	014950570
22x1,50	21,30	1	014950572

## 1495T

jogo 6 bujons e anilhas



M	€	1	014950503
13x1,25	17,50	1	014950503
13x1,50	17,50	1	014950513
15x1,50	17,50	1	014950515
17x1,50	19,70	1	014950517
20x1,50	21,80	1	014950520
22x1,50	29,00	1	014950522

## 1496/C

chave para bujões de óleo



8 x 10 mm	€ 19,10	3	014960010
-----------	---------	---	-----------

## 1497CEL

Ferramenta para remoção de terminais elétricos de veículos do grupo VAG

Permite a remoção fácil dos terminais, sem causar danos.



1497CEL	€ 18,60	1	014970170
---------	---------	---	-----------

## 1497D

Alicate para remoção de relays, pontas direitas

Permite a remoção fácil de todos os tipos de relays, sem o risco de os partir



1497D	€ 29,50	1	014970150
-------	---------	---	-----------

## 1497P

Alicate para remoção de relays, pontas angulares, 60°

Permite a remoção fácil de todos os tipos de relays, sem o risco de os partir



1497P	€ 31,00	1	014970160
-------	---------	---	-----------

## 1497/C23

Sortido 23 ferramentas para remoção de terminais eléctricos



1497/C23	€ 198,00	1	014970200
----------	----------	---	-----------

440x250x70 mm - 1,7 kg

## 1497/C94

sortido de 94 conectores de teste auto para utilização com as principais ferramentas de diagnóstico

- 2 machos em T
- 2 potenciômetros
- 2 luzes de aviso
- 2 conectores SRS
- 2 pinças
- 2 sondas de agulha
- 2 pinças para extracção de terminais
- 2 conectores tipo banana duplos
- 4 conectores tipo banana single
- 24 terminais tipo lingueta macho 0.6+6 mm
- 12 terminais redondos macho 1.6+3.9 mm
- 24 terminais tipo lingueta fêmea 0.6+6 mm
- 12 terminais redondos fêmea 1.6+3.9 mm



1497/C94	€ 347,00	1	014970300
----------	----------	---	-----------

430x390x100 mm - 3 kg

## 1497RC

Pinças para cabos rouba corrente, par

- secção do cabo: 1.5+3.5 mm
- voltagem: 0+330V
- corrente máx.: 5A



1497RC	€ 67,50	1	014970351
--------	---------	---	-----------

## 1498

verificador de tensão

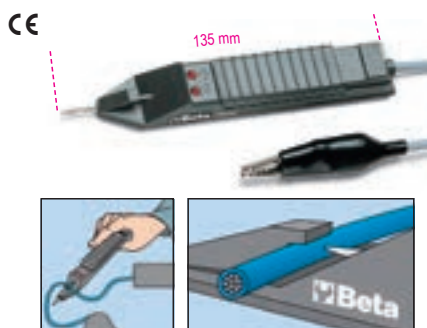

3=48V € 43,50 2 014980100

## 1498CM/12

Arrancador portátil para motos

3 funções numa só:

- arrancador
- bateria adicional para dispositivos eletrónicos (tablets, smartphones etc.)
- lanterna LED alta luminosidade



Equipamento:

- Cabo de arranque com pinças isoladas e díodo de proteção
- Carregador de bateria
- Carregador de isqueiro
- Cabo USB com adaptadores de carga

**CARACTERÍSTICAS TÉCNICAS**  
 Corrente de arranque: 200A  
 Pico de corrente : 400A  
 Saída USB: 5V 2,1A  
 Dimensões: 130x50x15 mm  
 Peso: aproximadamente 300 g

1498CM/12 € 210,00 1 014980030

## 1498MN/12

arrancador portátil multifunções

- Arranque de veículos motorizados com baterias de 12 volt (motores diesel e gasolina, até 2,000 cc)
- Carga de tablets, telemóveis e dispositivos eletrónicos em geral
- Tocha LED multiusos



ACESSÓRIOS STANDARD

- bateria cobalto de lítio
- cabos de arranque com grampos isolados e dispositivo de proteção contra inversão de polaridade e curto-circuitos
- porta USB para carga de dispositivos eletrónicos
- monitor digital e indicador de carga da bateria
- cabo USB com adaptadores de carga
- dispositivo de alimentação

CARACTERÍSTICAS TÉCNICAS

Corrente: 600A  
 Tipo de bateria: LiCoO2  
 Corrente de arranque : 12 volts

1498MN/12 € 322,00 1 014980000

## 1498MN/12-C

cabos de arranque com grampos para artigo 1498MN/12



1498MN/12-C € 51,50 1 014980005

## 1498MN/12-R

Dispositivo de alimentação para mini arrancadores LT/12-R



1498MN/12-R € 39,00 1 014980003

## 1498MN/12-P

Dispositivo de alimentação para mini arrancadores T/12-P



1498MN/12-P € 22,90 1 014980004

## 1498MN/12-U

Cabos USB com adaptadores universais U



1498MN/12-U € 16,40 1 014980009

## 1498LT/12

arrancador de baterias portátil de alta performance, ultra leve



Voltagem: 12 V  
 Amperagem contínua: 800 A  
 Amperagem máx. de arranque: 2000 A  
 Pico de amperagem: 4000 A  
 Comprimento do cabo: 500 mm  
 Tipo de bateria: 4 células LifePo4  
 Função de memorização: SIM  
 Dimensões: 260 x 135 x 72 mm  
 Peso: 2,5 kg  
 Com carregador 12 V 1,3A  
 Proteção eletrónica: SIM

1498LT/12 € 750,00 1 014980012

## 1498LT/12-SF

suporte de parede para arrancador 1498LT/12



1498LT/12-SF € 123,00 1 014980013

## 1498LT/12-R7

Arrancador portátil alta performance, ultraleve 1498LT/12



1498LT/12-R7 € 52,50 1 014980657

# Beta

## 1498/12

arrancador de baterias portátil para viaturas, 12V



### DADOS TÉCNICOS:

- Pico de corrente de arranque: 2200A
- Alça incluída
- Bateria blindada, electrólito sólido tipo (AGM)

1498/12 € 565,00 1 014980480

13 kg

## 1498/24

arrancador de baterias portátil para veículos ligeiros e comerciais, 12-24V



### DADOS TÉCNICOS:

- Pico de corrente de arranque: 4200A (12V) - 2100A (24V)
- Alça incluída
- Bateria blindada, electrólito sólido tipo (AGM)

1498/24 € 1.240,00 1 014980490

17 kg

## 1498B12/R02

bateria auxiliar 12V para arrancadores 1498B/12 e 1498B/24



1498B/12-R02 € 268,00 1 014980502

## 1498C/24

Arrancador com rodas, 24V



- Estrutura com rodas para facilidade de movimentos e esforço mínimo
- Excelente performance para todos os arranques, mesmo os mais exigentes
- Carregador de bateria electrónico incluído
- Sinalização luminosa e sonora em caso de inversão da polaridade
- Protecção contra picos de corrente
- Indicador de carga da bateria
- Bateria AGM de electrólito sólido

Amperagem contínua 1700 A  
 Voltagem de trabalho 24 V  
 Amperagem de arranque 4000 A  
 Comprimento do cabo 2000 mm  
 Secção do cabo 70 mm  
 Voltagem de carga 230 V  
 Carregador de bateria automático 24 V - 10 A

1498C/24 € 3.600,00 1 014980244

## 1498/2A

Carregador electrónico de baterias de motos, 12V

Permite o carregamento de todos os tipos de bateria Pb Wet, Agm, Gel, Mf e Vrla e baterias de lítio LiFePo4.



- Dois tipos de carga diferentes, para lítio e bateria de chumbo ácido, respetivamente
- Ciclo de carga automático multi-estágios
- Protecção contra inversão de polaridade e curtos circuitos
- Grau de protecção IP65
- Fornecido com cabo, grampos e cabo com olhais
- Voltagem: 220-240V

### CARACTERÍSTICAS TÉCNICAS:

- Corrente de carga: 1A
- Capacidade de carga: 2Ah-40Ah
- Frequência: 50-60 Hz
- Voltagem: 12V
- Dimensões: 180x80x40 mm
- Peso: 0.5 kg

1498/2A € 115,00 1 014980102

## 1498/4A

carregador de baterias electrónico para automóveis/motociclos, 6-12V



- protecção contra inversão de polaridade e curto-circuitos
- selecção automática de 6 ou 12 volt
- selecção automática do tipo de bateria
- monitor digital com iluminação
- gancho de fixação

### CARACTERÍSTICAS TÉCNICAS

Voltagem: 220V-240V  
 Frequência: 50-60 Hz  
 Corrente nominal (min-max): 1-4 Amp  
 Voltagem bateria: 6V/12V  
 Capacidade bateria: 4Ah-80Ah  
 Tempo de carga: 12 horas  
 Grau de protecção: IP65

1498/4A € 139,00 1 014980104

## 1498SA/2A-4A

Cabo com ligação a isqueiro para os artigos 1498 / 2A e 1498 / 4A



1498SA/2A-4A € 28,50 1 014980120

## 1498/8A

carregador baterias electrónico para automóveis ligeiros/ligeiros de mercadorias, 12V



- carga rápida e lenta (2A-8A)
- função recuperação da bateria
- função de alimentação 13.8V-5A
- protecção contra inversão de polaridade e curto-circuitos
- selecção manual do tipo de bateria
- monitor digital com iluminação
- gancho de fixação

### CARACTERÍSTICAS TÉCNICAS

Voltagem: 220V - 240V  
 Frequência: 50-60 Hz  
 Corrente nominal (min-max): 2-8 Amp  
 Voltagem da bateria: 12V  
 Capacidade da bateria: 5Ah-160Ah  
 Função de memorização: 13.8V - 5A  
 Grau de protecção: IP65

1498/8A € 195,00 1 014980108

## 1498/4A-8A CO

cabo com olhal para artigos 1498/4A e 8A



1498/4A-8A-CO € 13,70 1 014980114

## 1498/4A-8A CP

cabo com grampos para artigos 1498/4A e 8A



1498/4A-8A-CP € 17,50 1 014980118

## 1498/30A

Carregador de baterias eletrônico multiusos, 6-12-24V

Permite carregar baterias e fornecer energia a veículos a motor durante operações de diagnóstico



- corrente de carga máxima contínua: 30A
- carga e manutenção
- recuperação de baterias
- alimentação ECU
- proteção contra inversão de polaridade, curto-circuitos, voltagem incorreta e sobrecarga

Características Técnicas  
Alimentação 220-240V  
Potência 150 W  
Corrente de carga 5-30A  
Tipos de bateria Agm - Wet - Lítio (LiFePo4)  
Capacidade de carga 5-300Ah  
Capacidade manutenção 5-900Ah  
Voltagem 6-12-24 Volt  
Dimensões 330x270x130 mm  
Peso 4,2 kg

1498/30A € 889,00 1 014980130



## 1498/50A

carregador de baterias eletrônico multiusos, 12V

Para carregamento de veículos durante operações de reprogramação e autodiagnóstico



CE



### ESPECIFICAÇÕES

- Corrente max. carga/alimentação: 50 Amp
- carga
- recuperação de baterias
- alimentação para protocolos de diagnóstico ECU
- gestão eletrônica através de microprocessador
- proteção contra inversão de polaridade e curto-circuitos

### CARACTERÍSTICAS TÉCNICAS

Comprimento cabo: 3m  
Secção: 10 mm<sup>2</sup>  
Capacidade de carga: 5-500Ah  
Capacidade de manutenção: 5-1500Ah  
Voltagem: 12V

1498/50A € 1.475,00 1 014980050

150x100x250 mm

## 1498/120A

Carregador de baterias eletrônico multiusos, 12V

Permite carregar baterias e fornecer energia a veículos automóveis durante funções de programação e auto-diagnóstico



- corrente de carga máxima contínua: 120°
- carga e manutenção com microprocessador CPU
- função de recuperação de bateria
- alimentação ECU
- proteção contra inversão de polaridade, curto-circuitos, voltagem incorreta e sobrecarga

Características Técnicas  
Alimentação 90-260V  
Potência 1500 W  
Corrente de carga 10-120A  
Tipos de bateria Agm - Wet - Lítio (LiFePo4)  
Capacidade de carga 10-1200Ah  
Capacidade de manutenção 5-3600Ah  
Voltagem de saída 12 Volt  
Comp. cabo, com grampos 2700 mm  
Dimensões 310x150x350 mm  
Peso 8,5 kg

1498/120A € 2.570,00 1 014980142

## 1498/40A

carregador de baterias / arrancador multiusos, 12-24V com rodas



CE



- 3 ciclos de carga programados e 1 ciclo manual
- potenciômetro eletrônico de regulação
- ciclos de carga específicos WET-SPIRAL/GEL-AGM
- comando eletrônico e sistema de proteção
- processo de carga de 10 níveis
- função de dessulfatação e recuperação de baterias
- função alimentação
- voltagem dupla, 12-24V
- também adequado para baterias Start&Stop
- grampos profissionais em latão com isolamento em borracha

### CARACTERÍSTICAS TÉCNICAS

Potência de alimentação: 230V  
Voltagem de saída: 12-24V  
Corrente de carga: 1-40A  
Corrente de arranque: 350A max cc  
Capacidade de carga: 4-450Ah

1498/40A € 1.050,00 1 014980140

330x250x792

## 1498SM

bateria auxiliar, 12 V

Evita a perda de informação do computador de bordo durante trabalhos de manutenção ou substituição da bateria.



CE



- Características técnicas:
- auto-alimentada
  - bateria interna Pb 5 Ah
  - 12 volts
  - ligação profissional com tomada OBD

1498SM € 221,00 1 014980020

### 1498SM-C

União BD II, para segurança da memória de veículos, 12V, para o item 1498SM/C



1498SM-C € 24,00 1 014980021

### 1498SM-CP

Cabos de arranque com grampos, braçadeira de 12V para o artigo 1498SM/CP



1498SM-CP € 20,80 1 014980022

### 1498SM-A

Dispositivo USB para o item 1498SM/A



1498SM-A € 24,00 1 014980023

### 1498TB/12-24

teste digital de baterias e sistema de carga/ arranque 12-24 V

- permite realizar testes em: baterias, alternadores (inteligentes e standard) e arrancadores, diodos e chassis
- inclui software para teste de impressão a partir de PC
- display luminoso
- compacto, revestimento antichoque
- software em 10 línguas
- com entrada para ligação a mini-impressora amovível (acessório opcional, Beta 1498ST/TB)



#### Características Técnicas:

- Aplicações - teste de baterias 12V - teste carga de alternador, 12-24V - teste arrancador
- Intervalo de trabalho 100-2000 CCA
- Normas de referência CCA,SAE,DIN,EN,IEC,JIS
- Baterias compatíveis PB, WET, GEL, AGM, AGM FLAT, EFB
- Voltímetro 9V-36V
- Comprimento do cabo 1600 mm
- Línguas Italiano, Inglês, Francês, Alemão, Espanhol, Polaco, Romeno, Holandês, Sueco e Finlandês
- Acessórios incluídos cabo USB e software
- Peso 1,5 kg

1498TB/12-24 € 595,00 1 014980401

### 1498ST/TB

mini impressora

para aparelho de teste ref. 1498TB/12

- Pode ser directamente ligada ao aparelho de teste
- Permite imprimir os resultados do teste



CE

1498ST/TB € 212,00 1 014980410

### 1498ST/TB ROT

recarga de papel para impressora 1498ST/TB



1498ST/TB ROT € 9,30 2 014980411

### 1498PC

estabilizador de voltagem, 12-24 V

Protege unidades de controlo em processos de soldadura e arranque



1498PC € 87,50 1 014980801



### 1498TC

aparelho de teste digital para velas de incandescência

- Teste rápido e preciso de velas de incandescência
- Adequado para todos os tipos de velas de incandescência, 4.4-5-7-8.5-10-11 Volts
  - Visor digital com retroiluminação
  - Adequado para velas de incandescência em aço e cerâmica
  - Protecção contra curto-circuito e inversão de polaridade
  - Desliga-se automaticamente quando não estiver em utilização
  - Com aviso sonoro
  - Com lanterna SMD LED
  - Compacto, com estrutura anti-impacto



CE

- Intervalo de medição: 0.00±25.0Ω
- Tolerância: ± 2%
- Resolução: 0.01
- Visor led: 1.8"
- Temperatura de funcionamento: 0°C+50°C
- Alimentação: 1 pilha 9V (não incluída)

1498TC € 177,00 1 014980450

### 1499

estetoscópio



1499 € 89,00 1 014990001

## 1500/...

extractores universais  
com duas pernas

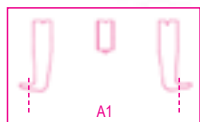

	L mm	€		
1500/1	100	74,50	1	015000301
1500/2	100	77,50	1	015000302
1500/3	150	128,00	1	015000303
1500/4	150	178,00	1	015000304
1500/5	205	322,00	1	015000305
1500/6	205	378,00	1	015000306
1500/7	205	567,00	1	015000307
1500/8	230	900,00	1	015000308

	A min+Max mm	A1 min+Max mm
1500/1	25÷80	70÷130
1500/2	25÷130	80÷180
1500/3	50÷160	105÷220
1500/4	60÷200	120÷270
1500/5	80÷250	160÷330
1500/6	80÷350	160÷420
1500/7	110÷520	195÷600
1500/8	170÷640	260÷715



	€		
1500/SP5	832,00	1	015000325
1500/1-1500/2-1500/3			
1500/4-1500/5			
1500/SPV	64,00	1	015000001

## 1500G/...

pernas tipo normal,  
para artigos 1500 e 1580/8I



	$\pm$ mm	$\ddagger$ 1500	€		
1500G/1	35	/1-2	49,00	1	015000311
1500G/3	35	/3-4	71,00	1	015000313
1500G/5	35	/5-6-7	143,00	1	015000315
1500G/8	50	/8	177,00	1	015000317
		1580/8I			

## 1500N/...

extractor universal de 2 pernas

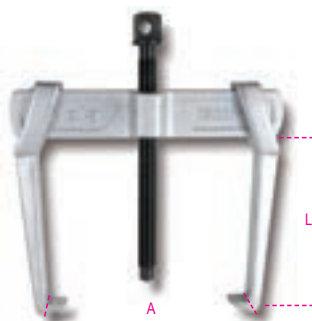

	A min+Max mm	L mm	€		
1500N/0	18÷65	70	66,00	1	015000600
1500N/1	23÷70	100	69,50	1	015000601
1500N/2	23÷100	100	75,00	1	015000602
1500N/3	35÷140	150	124,00	1	015000603
1500N/4	35÷190	150	133,00	1	015000604
1500N/5	43÷250	205	260,00	1	015000605
1500N/6	43÷320	205	278,00	1	015000606



	€		
1500N/SP6	725,00	1	015000626
1500N/0-1500N/1-1500N/2-1500N/3			
1500N/4-1500N/5			
1500N/SPV	70,00	1	015000006

## 1500N/G...

pernas para extractor 1500N



	$\pm$ mm	$\ddagger$ 1500N	€		
1500N/G0	10	/0	21,80	2	015000650
1500N/G1-2	12	/1-2	23,50	2	015000651
1500N/G3-4	17	/3-4	41,50	2	015000653
1500N/G5-6	23	/5-6	78,50	2	015000655



## 1501/1 - 2 - 3

extractores de pernas finas



	L mm	€		
1501/1	100	168,00	1	015010101
1501/2	200	179,00	1	015010102
1501/3	250	188,00	1	015010103

	A min+Max mm
1501/1	25÷130
1501/2	25÷130
1501/3	25÷130

## 1501G/1 - 2 - 3

pernas para 1501

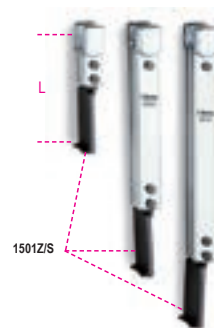

	L mm	€		
1501G/1	100	93,00	1	015010111
1501G/2	200	106,50	1	015010112
1501G/3	250	118,00	1	015010113

## 1501Z/S - P - R

terminal para pernas 1501G



	$\pm$ mm	D mm	€		
1501Z/S	2,0	27	33,50	2	015010211
1501Z/P	3,6	27	34,00	2	015010212
1501Z/R	3,6	14	37,50	2	015010213

## 1505V

extractor do braço limpa pára-brisas dianteiro e traseiro

Ponta de bronze perfurada amovível para extração do braço, com jacto de água

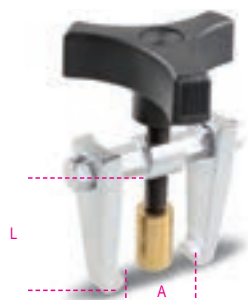

1505V	A Max mm	L mm	€	1	015050001
	43	37	38,00		

## 1505/C5

kit extractores do braço limpa pára-brisas

1 extractor de 2 pernas, Ø 25÷40 mm  
4 chaves curvas, Ø 25 mm, Ø 30 mm, Ø 35 mm, Ø 41 mm



mm	€	1	015050300
12	129,00		

320x150x60 mm - 1,2 kg

## 1506

extractor de duas pernas com aperto automático

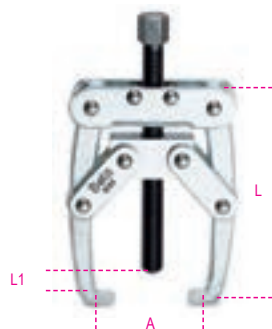

1506	A min+Max mm	L mm	L1 mm	€	1	015060001
	10÷50	80	40	40,50		

## 1508/1 - 1508/2

extractores de duas pernas, série ligeira



1508/1	L mm	€	1	015080001
	105	132,00		
1508/2	L mm	€	1	015080002
	130	157,00		

1508/1	A min+Max mm	L1 mm
	6÷100	105
1508/2	A min+Max mm	L1 mm
	10÷140	130

## 1511/1 - 1511/3

extractores exteriores com duas pernas reversíveis

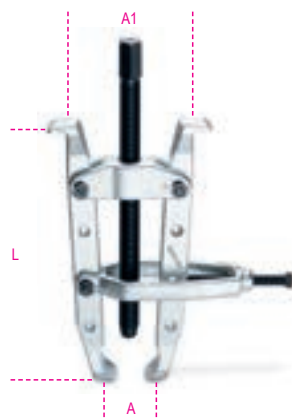

1511/1	L mm	€	1	015110001
	235	226,00		
1511/2	L mm	€	1	015110002
	330	282,00		
1511/3	L mm	€	1	015110003
	405	349,00		

1511/1	A min+Max mm	A1 min+Max mm
	20÷100	65÷95
1511/2	A min+Max mm	A1 min+Max mm
	40÷150	103÷190
1511/3	A min+Max mm	A1 min+Max mm
	40÷150	103÷175

## 1515/1 - 2 - 3

extractores com duas pernas oscilantes

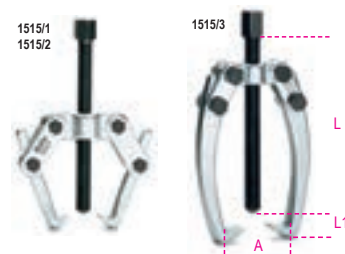

1515/1	L mm	€	1	015150101
	85	30,00		
1515/2	L mm	€	1	015150102
	85	32,50		
1515/3	L mm	€	1	015150103
	105	47,50		

1515/1	A Max mm	L1 mm
	60	105
1515/2	A Max mm	L1 mm
	70	105
1515/3	A Max mm	L1 mm
	90	105

## 1516/1 - 2 - 3

extractor com três pernas oscilantes



1516/1	L mm	€	1	015160001
	85	43,50		
1516/2	L mm	€	1	015160002
	85	46,50		
1516/3	L mm	€	1	015160003
	105	65,50		

1516/1	A Max mm	L1 mm
	60	85
1516/2	A Max mm	L1 mm
	70	85
1516/3	A Max mm	L1 mm
	90	105

## 1517

extractor de 3 pernas com bloqueio automático

- Para maiores cargas de extração.
- Efeito autoblocante

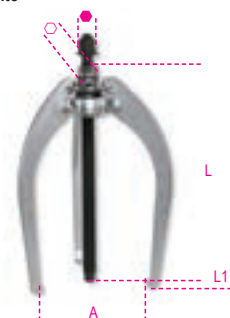

1517/90	L mm	L1 mm	Ø mm	€	1	015170000
	182	60	22	227,00		
1517/150	L mm	L1 mm	Ø mm	€	1	015170010
	242	115	22	236,00		
1517/200	L mm	L1 mm	Ø mm	€	1	015170020
	307	150	22	271,00		
1517/260	L mm	L1 mm	Ø mm	€	1	015170030
	395	180	30	314,00		

1517/90	Ø mm	A mm	kg	N
	19	18÷90	6000	59000
1517/150	Ø mm	A mm	kg	N
	19	25÷150	6000	59000
1517/200	Ø mm	A mm	kg	N
	19	40÷200	6000	59000
1517/260	Ø mm	A mm	kg	N
	27	50÷260	8000	78500

**Beta**

**Beta**

## 1518/...

extractores com três pernas



L	€	1	
1518/1 105	73,50	1	015180001
1518/2 135	94,00	1	015180002
1518/3 235	163,00	1	015180003
1518/4 270	240,00	1	015180004
1518/5 270	281,00	1	015180005
1518/6 270	295,00	1	015180006

A	L1
1518/1 24÷100	105
1518/2 32÷160	150
1518/3 40÷220	220
1518/4 80÷250	240
1518/5 80÷300	350
1518/6 80÷350	400

## 1520/1 - 1520/2

extractores com duas pernas reversíveis

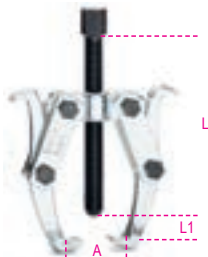

L	€	1	
1520/1 135	70,00	1	015200101
1520/2 235	119,00	1	015200102

A	L1
1520/1 110	85
1520/2 160	140

## 1521/1 - 1521/2

extractores com três pernas reversíveis



L	€	1	
1521/1 135	90,00	1	015210101
1521/2 235	155,00	1	015210102

A	L1
1521/1 110	90
1521/2 160	140

## 1529

extractor multi-passos para polias cónicas

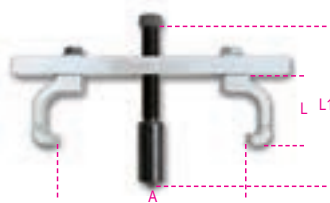

A	L	L1	€	1	
24÷240	60÷95	90÷135	232,00	1	015290000

260x210x60 mm - 2,6 kg

## 1529/C7

kit extractores de polia

Contém:

- extrator de 2 pernas com 2 pés 4.7 mm espessura
  - extrator de 2 pernas com 1 pé 4.3 mm espessura
  - extrator de 1 perna com 2 pés 2.3 mm espessura
  - extrator de 1 perna com 1 pé 2.3 mm espessura
- O par de pernas pode ser constituído de acordo com as necessidades do trabalho



L	L1	A	€	1	
1529/C7 50	72,5	53÷114	132,00	1	015290100

285x155x50 mm - 2 kg

## 1529PI

extractor de polia da bomba injectora

- remoção rápida e precisa da polia de injeção de combustível
- particularmente adequado para veículos Fiat, Ford, Volkswagen, Citroën e Peugeot

Inclui 3 parafusos para fixar o extrator na polia:

- M6 x 1.0 x 49 mm
- M7 x 1.0 x 75 mm
- M8 x 1.25 x 76 mm



€	1	
1529PI 95,00	1	015290051

## 1530/C5

Kit extractores dos cubos das rodas e rolamentos,

3, 4, 5 orifícios

Contúdo:

- 1 flange universal (96÷138 mm)
- 1 parafuso hidráulico (12 t)
- 1 batente para martelo (2.8 kg), necessário para cubos sem parafusos de fixação centrais



€	1	
1530/C5 480,00	1	015300300

760x320x120 mm - 11,5 kg

## 1530/C16

kit para extração de cubos de rodas e rolamentos, com prato, 3, 4, 5 furos

Ideal para cubos de rodas com anéis centrais projetados

Inclui:

- 1 flange universal (90÷130 mm)
- 1 contra-peso (5 kg)
- 4 parafusos M12
- 4 parafusos M14



€	1	
1530/C16 584,00	1	015300316

760x310x100 mm - 13,5 kg

## 1532

extractor de juntas



€	2	
1532 14,80	2	015320001



## 1533/...

forças para separadores refª. 1534



L mm	€	1	015330002
1533/2 150	98,50	1	015330002
1533/3 210	188,00	1	015330003
1533/4 315	297,00	1	015330004
1533/5 305	356,00	1	015330005

A min+Max mm	L1 mm
1533/2 45÷130	110
1533/3 85÷225	175
1533/4 80÷285	175
1533/5 145÷370	235

## 1533PR/1 - 2 - 3

extensões para forças refª. 1533



	€	1	015330011
1533PR/1	21,80	1	015330011
1533/2			
1533PR/2	23,50	1	015330012
1533/3			
1533PR/3	25,00	1	015330013
1533/4-5			

## 1534/...

separadores

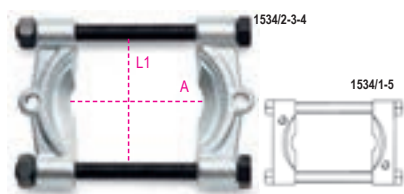

	€	1	015340001
1534/1 1533/2	86,50	1	015340001
1534/2 1533/2	101,50	1	015340002
1534/3 1533/3	169,00	1	015340003
1534/4 1533/4	283,00	1	015340004
1534/5 1533/5	593,00	1	015340005

A min+Max mm	L1 mm
1534/1 5÷60	88
1534/2 12÷75	118
1534/3 22÷115	160
1534/4 25÷155	205
1534/5 30÷220	290

## 1535/C...

jogos de forças e separadores



1535/C1	€	1	015350001
---------	---	---	-----------

1533/2			
1533PR/1			
1534/1			
260x180x40 mm - 2,5 kg			

1535/C2	€	1	015350002
---------	---	---	-----------

1533/2			
1533PR/1			
1534/2			
260x180x40 mm - 2,8 kg			

1535/C3	€	1	015350003
---------	---	---	-----------

1533/3			
1533PR/2			
1534/3			
380x280x55 mm - 8,0 kg			

1535/C4	€	1	015350004
---------	---	---	-----------

1533/4			
1533PR/3			
1534/4			
420x380x65 mm - 14,8 kg			

1535/C5	€	1	015350005
---------	---	---	-----------

1533/5			
1533PR/3			
1534/5			
530x510x85 mm - 27,4 kg			

## 1539

extractor de percussão para chapa



1539	€	1	015390001
------	---	---	-----------

## 1540

extractor de percussão

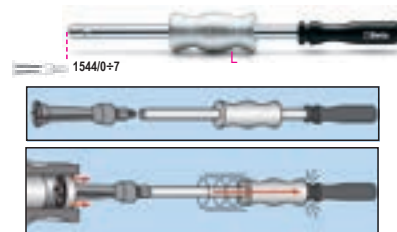

L mm	A mm	1544 0÷7	€	1	015400001
---------	---------	-------------	---	---	-----------

## 1542/1 - 1542/2

extractores de duas pernas para expansores



1542/1	A min+Max mm	1544 0÷7	€	1	015420001
--------	--------------------	-------------	---	---	-----------

1542/2	60÷130	9C-10C	108,00	1	015420002
	A min+Max mm	A1 mm			
1542/1	35÷75	105			
1542/2	60÷130	160			

## 1544/...

pinças de expansão para interiores

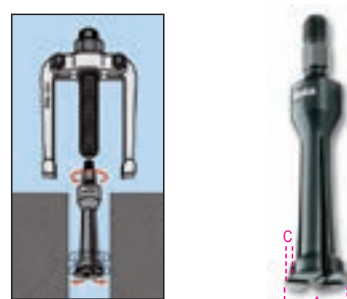

1544/0	C mm	A mm	€	1	015440100
--------	---------	---------	---	---	-----------

A= 5÷7			65,00	1	015440100
1544/A	0,80	M10	66,50	1	015440105
A= 7÷9					
1544/1	0,80	M10	67,50	1	015440110
A= 9÷12					
1544/2	1,15	M10	69,50	1	015440120
A= 13÷17					
1544/2B	1,00	M10	70,00	1	015440121
A= 14÷19					
1544/3	1,70	M10	72,00	1	015440130
A= 16÷21					
1544/4	1,65	M10	80,00	1	015440140
A= 20÷25					
1544/5	2,00	M10	86,50	1	015440150
A= 25÷30					
1544/6	3,00	M10	108,00	1	015440160
A= 30÷37					
1544/7	3,80	M10	125,00	1	015440170
A= 38÷45					
1544/9C	2,60	G 3/8"	175,00	1	015440189
A= 40÷75					
1544/10C	7,30	G 3/8"	249,00	1	015440199
A= 70÷115					

## 1545/C5M

extractor refª. 1542/1  
com 5 expansores da refª. 1544



1545/C5M € 477,00 1 015450011

- 1542/1 ● 24 mm
- 1544/1 9+12 mm
- 1544/2 13+17 mm
- 1544/3 16+21 mm
- 1544/4 20+25 mm
- 1544/5 25+30 mm

265x180x45 mm - 2,4 kg

## 1547/C6

extractor de rolamentos de esferas



1547/C6 € 249,00 1 015470006

420x185x60 mm - 3 kg

## 1547KP

jogo de 3 pares de terminais redondos falsos



	∅ mm	€		
1547KP/1	9-11-12,5	40,00	1	015470106
1547KP/2	5-6-8	26,00	1	015470206

## 1547P

extensões hexagonais



	L mm	∅ mm	€		
1547P/1	205	1547/1	8,20	1	015470101
1547P/2	102	1547/2	5,45	1	015470201

## 1547PC/2

extensões redondas, série curta



	L mm	∅ mm	€		
1547PC/2	42	1547/2	4,40	1	015470202

## 1547PL/2

extensões redondas, série longa



	L mm	∅ mm	€		
1547PL/2	106	1547/2	4,95	1	015470203

## 1548/C8

Extrator do rolamento interno da caixa de velocidades para veículos do grupo FCA e Opel

Fornecido com 2 pares de pernas e 4 apoios diferentes para ajustar aos diferentes modelos fabricados desde 2007

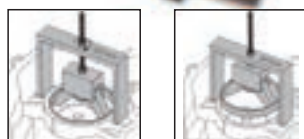

1548/C8 € 504,00 1 015480800

## 1549

kit para remoção e instalação de amortecedores de duplo efeito a gás

Permite manter a haste direita ao instalar as molas



1549 € 344,00 1 015490001

310x270x110 mm - 3 kg

## 1550U

prensa pneumática para molas de amortecedores de automóveis, carrinhas e veículos comerciais

CE

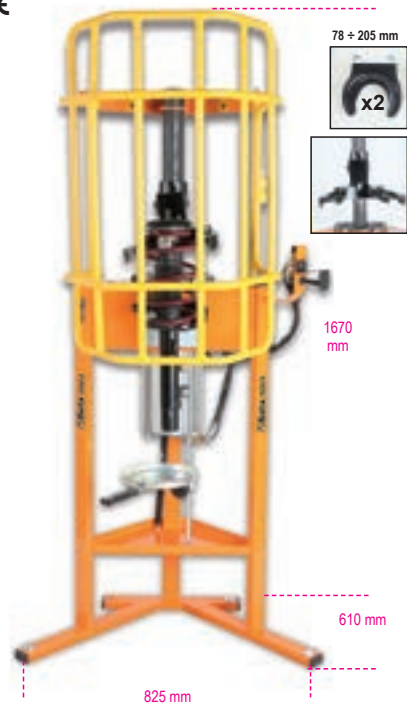

MAIOR POTÊNCIA: pressão máxima 2 toneladas (10 bars)  
SISTEMA DE FIXAÇÃO SUPERIOR UNIVERSAL: permite a compressão de todos os diâmetros de mola esq./dir. com um prato superior adaptável  
SISTEMA DE SEGURANÇA ATIVO NA MOLLA: gancho de segurança e 3 válvulas de bloqueio permitem o posicionamento correto da mola, mantendo a posição durante a compressão. Se a mola não estiver na posição correta, o sistema imobiliza a máquina  
GRELHA DE PROTEÇÃO: máxima segurança e cobertura da área de trabalho  
ALAVANCA DE COMANDO: maior precisão e sensibilidade durante a compressão  
POSIÇÃO DE TRABALHO: altura de trabalho no garfo posterior elevado até 875 mm

Fornecido com 2 garfos inferiores para diâm. 78-205 mm

CARACTERÍSTICAS TÉCNICAS

Pressão máxima:  
2 toneladas (10 bars) - 1.6 toneladas (8 bars) - 1.2 toneladas (6 bars)  
Curso compressão da mola: 335 mm

1550U € 2.640,00 1 015500010

## 1550U/CGS-R

Garfos superiores rebaixados, para item 1550U



1550U CGS-R € 491,00 1 015500035

### 1550U/MRC-ABE

garfos especiais para artigo 1550U, especialmente concebidos para veículos Mercedes classe A-B-E



1550U/MRC-ABE € 507,00 1 015500031

### 1550U/MRC-C

garfos especiais para artigo 1550U, especialmente concebidos para veículos Mercedes classe C



1550U/MRC-C € 442,00 1 015500032

### 1550U/S...

forquilha para artigo 1550U



	∅ mm	€		
1550U/S 130	78÷130 mm	330,00	1	015500014
1550U/S 182	105÷182 mm	330,00	1	015500015
1550U/S 205	125÷205 mm	330,00	1	015500016

### 1550U/SS187

garfo esquerdo para item 1550U

Particularmente adequado para molas esquerdas, por ex. em: Nissan Qashqai e Renault Koleos



1550U/SS 187 € 330,00 1 015500018

### 1550U/M

tomo para ferramenta remoção de amortecedores 1550U

Permite bloquear a haste do amortecedor



1550U/M € 312,00 1 015500021

### 1555/Q

compressor para molas de amortecedores MacPherson e equivalentes  
Impulso máx.: 1500 kg

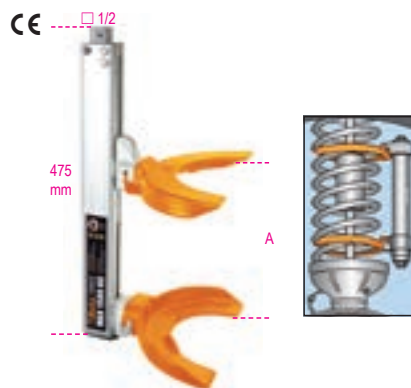

A	∅	€		
min+Max mm	min+Max mm			
65÷354	80÷195	709,00	1	015550006

### 1555/QS

compressor para molas de amortecedores tipo MacPherson e equivalente

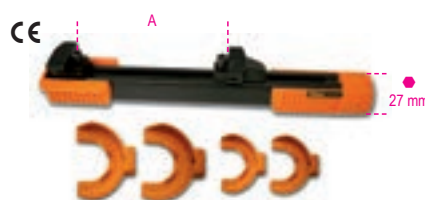

A	∅	€		
min+Max mm	min+Max mm			
70÷300	80÷200	872,00	1	015550005

### 1555S/BMW-RNT

forquilha para BMW E39, amortecedores E46 e Renault Mégane II, para artigos 1555DS e 1555/QS



1555S/BMW-RNT € 273,00 1 015550303

### 1555C

compressor telescópico para molas de amortecedores com 4 matrizes e barra de torção



A	∅	N	t	€		
min+Max mm	min+Max mm					
80÷225	90÷160	25000	8,5	862,00	1	015550202

### 1556/1A

compressores de molas de amortecedores

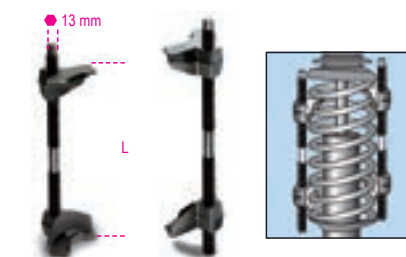

min L Max mm	€		
65÷320	207,00	1	015560101

### 1556/2A

compressores de molas de amortecedores

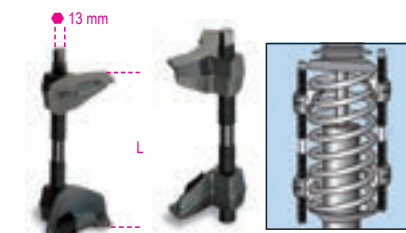

min L Max mm	€		
65÷200	204,00	1	015560102

### 1557

chave de caixa para casquilhos de amortecedores de camião



L mm	L1 mm	€		
37	28	77,50	1	015570137
46	34	78,50	1	015570146
56	34	84,00	1	015570156

### 1557V

chaves de caixa para casquilhos de amortecedores Volvo



mm	€		
27	40,50	1	015570299

### 1557/S3

jogo de 3 chaves para casquilhos de amortecedores

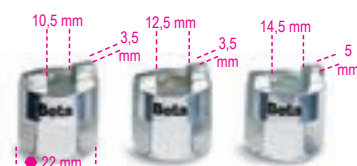

€		
60,00	1	015570010

## 1558/C4

ferramenta para anel retentor interno e externo, operada por parafuso

Encabadouro quadrado permite a aplicação de uma força elevada em ambas as condições de operação

Pontas fornecidas:  
Ø 2.5-3-3.5 mm



Ø mm	Ø mm	€	📦	📄
1558/C4	5,5 ÷ 77	5,5 ÷ 77	144,00	1 015580100

330x220x50 mm - 900 g

## 1558P

Par de pontas para anéis de retenção para artigo 1558



Ø mm	€	📦	📄
2,5	6,25	1	015580125
3,0	6,25	1	015580130
3,5	6,25	1	015580135

## 1559

extractor se rótulas tipo ligeiro

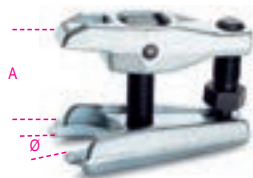

	A Max mm	Ø mm	€	📦	📄
1559/22	50	18÷22	77,00	1	015590001
1559/36	90	36	349,00	1	015590036
1559/45	115	45	529,00	1	015590045

## 1559V/8T

parafuso hidráulico para extractores de rótulas 1559/36 e 1559/45



Nm	t	€	📦	📄
80000	8	260,00	1	015590145

## 1560/1 - 1560/2

extractor de rótulas modelo profissional



	A min=Max mm	Ø mm	€	📦	📄
1560/1	12÷50	20	132,00	1	015600001
1560/2	60÷85	20	163,00	1	015600002

## 1560A

extractor de rótulas



	€	📦	📄
1560A	224,00	1	015600601

## 1561/...

extractor de rótulas



	L mm	A mm	Ø mm	€	📦	📄
1561/1	39	36,6	18	58,50	1	015610001
1561/2	47	45,7	25	76,50	1	015610002
1561/3	63	62	30	112,00	1	015610003
1561/4	75	63	40	144,00	1	015610004

## 1562D

extractor de rótulas

Fornecido com 2 parafusos para extracção de rótulas da suspensão e da direcção



A max mm	Ø mm	mm	L mm	€	📦	📄
50	39	26	155	295,00	1	015620239

## 1565/1 - 2 - 3

extractor de rótulas por percussão



	Ø mm	L1 mm	€	📦	📄
1565/1	18	65	68,00	1	015650001
1565/2	23	65	75,50	1	015650002
1565/3	30	88	78,50	1	015650003

## 1566N

ferramenta para remoção/instalação de braços de direcção



Ø x L mm	Ø mm	mm	€	📦	📄
28÷35 x 400	27	12"	108,00	1	015660005
35÷45 x 190	27	-	107,00	1	015660008
35÷45 x 400	27	12"	118,00	1	015660010

## 1566/G01

extractor de rótulas homocinético

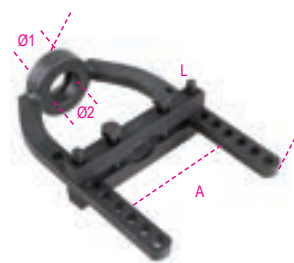

L mm	A mm	Ø1 mm	Ø2 mm	€	📦	📄
250	115	29	36	128,00	1	015660052

## 1566P

alicate de freios para veios estriados

O alicate comprime o circlip, facilitando o encaixe do veio do eixo na junta homocinética



L mm	A Max mm	€	📦	📄
280	36	58,00	1	015660091

## 1567

alavanca para extracção do terminal do braço oscilante da suspensão e dos amortecedores

Utilização apenas por um operador



A mm	B min+Max mm	€	📦	📄
1060	100÷300	294,00	1	015670001

## 1569/A

jogo de ferramentas para extracção e colocação de sino-blocos no eixo traseiro, vedantes de óleo do eixo de direcção e rolamentos das rodas

- Possibilidade de utilização dos casquilhos no veículo ou na prensa hidráulica
- Contém: 4 veios roscados: M10-M12-M14-M16 4 anilhas casquilhos para diâmetros entre 44 mm e 82 mm



1569/A € 907,00 1 015690011

530x415x115 mm

## 1569/B

Jogo de ferramentas para extração e instalação de sinoblocos, vedantes de óleo e rolamentos de rodas

Diâmetro: 14÷32 mm



1569/B € 709,00 1 015690015

## 1569/F

jogo ferramentas para remoção e inserção de sinoblocos em Fiat Panda, Fiat 500 e Ford Ka



1569/F € 387,00 1 015690021

## 1569CP

chave de pancada para instalação de rolamentos cônicos e vedantes

Ajuste rápido

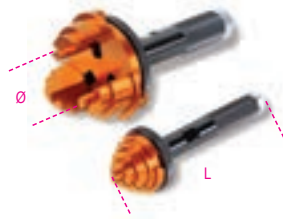

	Ø min+Max mm	L mm	€		
1569CP/50	9,5÷50	130	116,00	1	015690750
1569CP/90	18÷90	145	144,00	1	015690790

## 1570/3

pressas hidráulicas para extractores



t	L mm	L1 mm	Ø mm	€	
30	243	36	19	204,00	1 015700003

## 1580/8I

extractor hidráulico universal com duas pernas

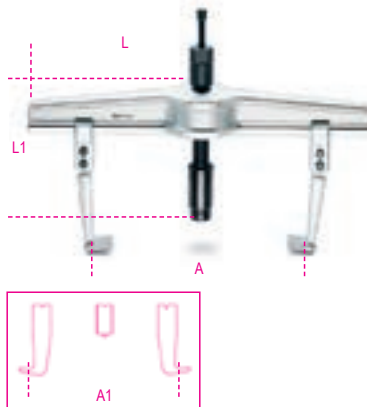

1580/8I € 1.350,00 1 015800008

	A min+Max mm	L mm	L1 mm	A1 min+Max mm	N Max
1580/8I	170÷640	715	280	260÷715	180000

## 1580GL

pernas soltas, série longa, para extractores 1580/8I



	L mm	€		
1580GL/8A	300	153,00	1	015800227
1580GL/8B	400	169,00	1	015800228
1580GL/8C	500	216,00	1	015800229

## 1585/5I - 6I - 7I

extractores hidráulicos de três pernas

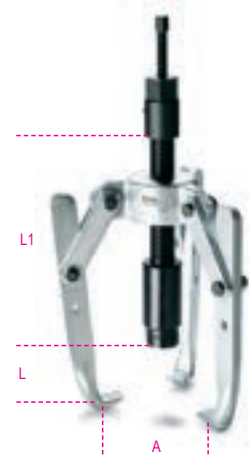

	€		
1585/5I	949,00	1	015850005
1585/6I	981,00	1	015850006
1585/7I	1.014,00	1	015850007

	A min+Max mm	L1 mm	L mm	N Max
1585/5I	50÷350	135	280	150000
1585/6I	50÷350	235	280	150000
1585/7I	50÷350	335	280	150000

## 1585GI/5 - 6 - 7

pernas para extractor hidráulico ref.<sup>a</sup> 1585/I-1585/6I-1585/7I

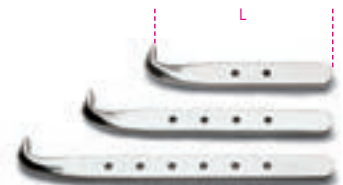

	L mm	€		
1585GI/5	135	87,50	1	015850205
1585GI/6	235	104,00	1	015850206
1585GI/7	335	126,00	1	015850207

## 1589VI

fuso hidráulico para extractores 1580/8I e 1585/5I-1585/6I-1585/7I

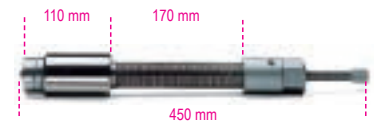

1589VI € 556,00 1 015890001

## 1589PI/50 - 100 - 150

extensão para fuso hidráulico



	L mm	L1 mm	€		
1589PI/50	50	70	50,50	1	015890005
1589PI/100	100	120	57,00	1	015890010
1589PI/150	150	170	62,50	1	015890015

## 1590

extensão para fuso hidráulico



A max mm	L1 mm	€	🔧	📦
60	55	23,00	2	015900305
80	65	30,00	2	015900307
100	65	37,50	2	015900310
120	85	43,00	2	015900312
150	95	61,50	2	015900315

## 1591

grampos de carpinteiro



A ~	A max mm	L1 mm	€	🔧	📦
200	200	80	24,60	2	015910020
300	310	85	31,00	2	015910030
400	410	85	32,50	2	015910040
500	500	95	43,00	2	015910050
600	600	95	45,00	2	015910060
800	800	95	53,00	2	015910080
1000	1000	110	66,50	2	015910100

## 1593

grampos com fuso

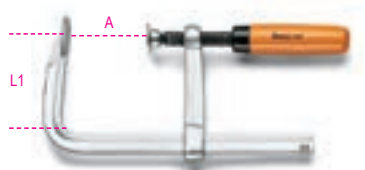

A ~	A max mm	L1 mm	€	🔧	📦
160	170	80	30,00	2	015930016
200	240	100	45,00	2	015930020
300	320	145	63,50	2	015930030

## 1594

grampos com alavanca

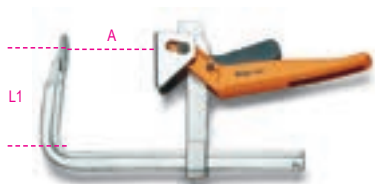

A ~	A max mm	L1 mm	€	🔧	📦
200	240	145	96,50	1	015940020
250	290	145	101,50	1	015940025
300	340	145	109,00	1	015940030
400	430	150	114,00	1	015940040
500	530	150	120,00	1	015940050
600	630	150	125,00	1	015940060

## 1595

grampos com fuso

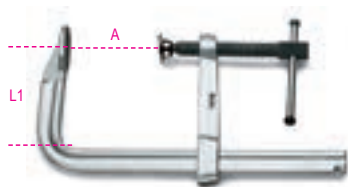

A ~	A max mm	L1 mm	€	🔧	📦
200	230	100	47,00	2	015950020
250	270	120	51,00	2	015950025
300	330	120	64,50	2	015950030
400	420	120	72,50	2	015950040
500	520	125	78,50	2	015950050
600	620	125	83,50	2	015950060
800	820	125	98,50	1	015950080
1000	1030	125	109,00	1	015950100

## 1599F

tornos paralelos de bancada

com topo e guias reforçados



L1 mm	BxH mm	Ø mm	A MAX mm	€	🔧	📦
100	92x46	11	125	294,00	1	015990100
125	108x54	13	150	370,00	1	015990125
150	125x62	13	200	520,00	1	015990150
175	140x70	15	220	698,00	1	015990175

## 1599P

tornos paralelos de bancada

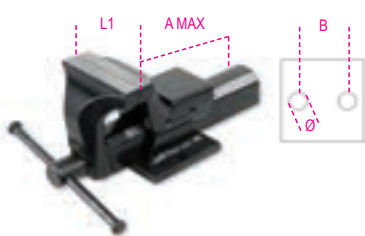

L1 mm	B mm	Ø mm	A MAX mm	€	🔧	📦
100	92	11	111	256,00	1	015990000
125	108	13	130	306,00	1	015990025
150	130	15	170	426,00	1	015990050

## 1599B

bases rotativas para artigo 1599P



1599P	€	🔧	📦
1599B 100	107,00	1	015990810
1599B 125	121,00	1	015990812
1599B 150	151,00	1	015990815

## 1599T

tornos paralelos de perfuração

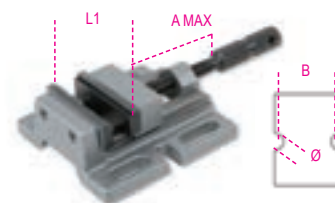

L1 mm	B mm	Ø mm	A MAX mm	€	🔧	📦
80	111	11	65	144,00	1	015990480
100	120	13	87	179,00	1	015990500

## 1599G

par de protecções de alumínio



A mm	€	🔧	📦
100	47,50	1	015990910
125	50,00	1	015990912
150	53,00	1	015990915
180	59,50	1	015990917

## 1601/PC

alicate para cravar terminais de cabos de telefone e de transmissão de dados

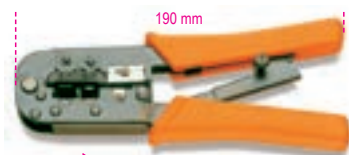

RJ11-RJ12-RJ45	€	🔧	📦
	56,00	2	016010011

## 1602

alicate para cravar terminais isolados série ligeira



mm <sup>2</sup>	€	🔧	📦
0,75÷6	13,70	5	016020001

## 1602/C9T

alicate para cravar terminais com jogo de 450 terminais



1602/C9T € 147,00 1 016020013

1602	n.
1602	1
1620 R/6,3	50
1620 B/6,3	50
1620 G/6,3	50
1624 R/6,3	50
1624 B/6,3	50
1624 G/6,3	50
1628 R/1,6	50
1628 B/2,3	50
1628 G/3,6	50

420x350x35 mm - 1,5 kg

## 1602A

alicate para cravar terminais isolados modelo standard

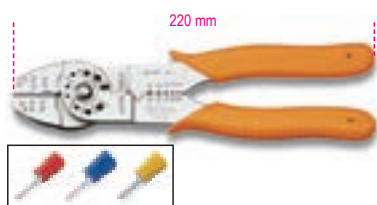

mm<sup>2</sup> 0÷6 € 51,50 2 016020005

## 1603

alicate para cravar terminais não isolados série ligeira

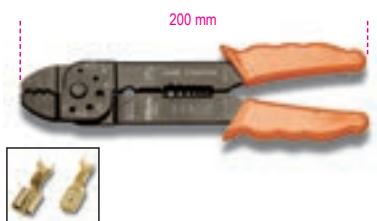

mm<sup>2</sup> 1,25÷5,5 € 13,70 5 016030001

## 1603A

alicate para cravar terminais não isolados fechados modelo standard

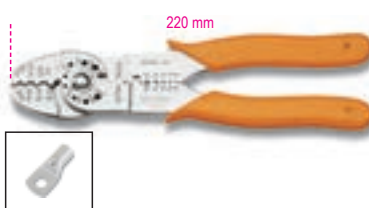

mm<sup>2</sup> 0÷8 € 51,50 2 016030005

## 1603B

alicate para cravar terminais não isolados abertos modelo standard

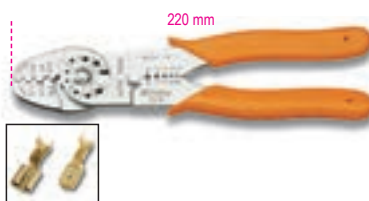

mm<sup>2</sup> 0÷8 € 52,00 2 016030010

## 1604

alicate de pressão para cravar terminais isolados



mm<sup>2</sup> 0,5÷6 € 87,50 1 016040001

## 1604/C9T

alicate de pressão 1604 com jogo de 450 terminais



1604/C9T € 221,00 1 016040013

1604	n.
1604	1
1620 R/6,3	50
1620 B/6,3	50
1620 G/6,3	50
1624 R/6,3	50
1624 B/6,3	50
1624 G/6,3	50
1628 R/1,6	50
1628 B/2,3	50
1628 G/3,6	50

420x350x35 mm - 2 kg

## 1605

alicate de pressão para cravar terminais não isolados

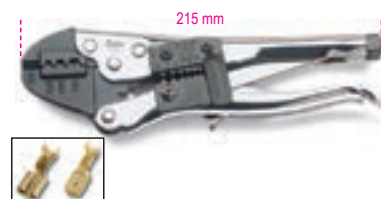

mm<sup>2</sup> 0,5÷6 € 87,50 1 016050001

## 1606

alicate para cravar terminais cilíndricos, serviço pesado



mm<sup>2</sup> 0,5÷6 € 295,00 1 016060001

## 1606A

alicate de cravar terminais tubulares



1606A6	mm <sup>2</sup>	€	1	016060010
1606A6	0,5÷6	81,00	1	016060010
1606A16	6÷16	81,00	1	016060016

## 1606A/C9

alicate de cravar para terminais tubulares com jogo de 450 terminais, 0,5÷6 mm<sup>2</sup>



1606A/C9 € 153,00 1 016060100

1606A	n.
1606A	1
1632 W/0,5K	50
1632 N/1,5K	100
1632 B/2,5K	100
1632 G/4K	100
1632 Y/6K	100

420x350x35 mm - 2,5 kg



## 1607

alicates para cravar terminais de cabo coaxial BNC RG 58, RG 59, RG 62, RG 71



6,48 - 5,41 - 1,69 mm

1607	L mm	A mm	B mm	€	mm²	1	016070001
	220	73	19	269,00			

## 1608

alicate para cravar terminais isolados, com regulador de pressão



mm²	€	1	016080001
0,5÷6	104,00		

## 1608/C9T

alicate 1608 com jogo de 450 terminais



1608/C9T	€	1	016080013
	237,00		

1608	n.
1620 R/6,3	50
1620 B/6,3	50
1620 G/6,3	50
1624 R/6,3	50
1624 B/6,3	50
1624 G/6,3	50
1628 R/1,6	50
1628 B/2,3	50
1628 G/3,6	50

420x350x35 mm - 2 kg

## 1608A

alicate para cravar terminais isolados, para serviço pesado



mm²	€	1	016080005
0,75÷6	210,00		

## 1609

alicate para cravar terminais não isolados modelo profissional

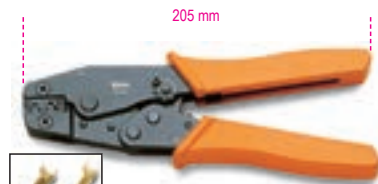

mm²	€	1	016090001
0,5÷2,5	104,00		

## 1609A

alicate para cravar terminais não isolados, para serviço pesado



mm²	€	1	016090005
0,5÷6	409,00		

## 1609B

alicate de cravar terminais para terminais não isolados matrizes, 10 mm² ÷ 120 mm²



L mm	mm²	€	1	016090101
600	10÷120	276,00		

## 1609C/C5

alicate para cravar terminais hidráulico com 5 pares de matrizes

matrizes hexagonais, 25 mm² ÷ 240 mm²



mm²	€	1	016090210
50÷240	1.780,00		

500x300x110 mm - 4 kg

## 1609M

matrizes para artigo 1609C

matrizes hexagonais



mm²	€	1	016090221
1609M/16 10-16	63,50		
1609M/35 25-35	63,50		
1609M/70 50-70	63,50		
1609M/120 95-120	63,50		
1609M/150 150	63,50		
1609M/185 185	63,50		
1609M/240 240	63,50		

## 1610

terminais com olhal

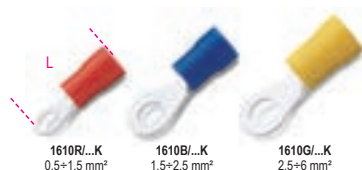

1610R/...K 0,5÷1,5 mm² 1610B/...K 1,5÷2,5 mm² 1610G/...K 2,5÷6 mm²

1602; 1602A; 1604; 1606; 1608A

D mm	mm²	L mm	€	1	016100104
1610R/4K 4	0,5-1,5	17	15,50		
1610R/5K 5	0,5-1,5	20	15,50		
1610B/5K 5	1,5-2,5	22	18,40		
1610B/6K 6	1,5-2,5	27	23,80		
1610B/8K 8	1,5-2,5	27	23,80		
1610G/6K 6	2,5-6	31	34,50		
1610G/8K 8	2,5-6	34	43,50		

Os preços indicados são para 100 unidades

**Beta**



## 1614

terminais pontiagudos

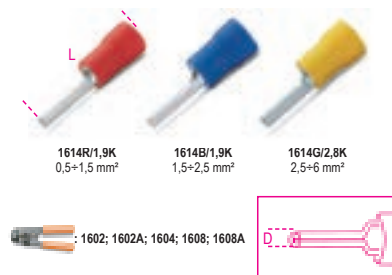

	D mm	L mm	€		
1614R/1,9K	1,9	0,5-1,5	21	18,40	1 016140101
1614B/1,9K	1,9	1,5-2,5	21	20,80	1 016140102
1614G/2,8K	2,8	2,5-6	25	41,00	1 016140103

Os preços indicados são para 100 unidades

## 1616

terminais cilíndricos, macho

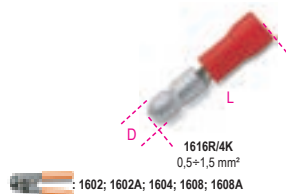

	D mm	L mm	€		
1616R/4K	4	0,5-1,5	21	16,60	1 016160104

Os preços indicados são para 100 unidades

## 1618

terminais cilíndricos, fêmea

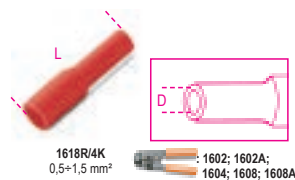

	D mm	L mm	€		
1618R/4K	4	0,5-1,5	24	21,00	1 016180104

Os preços indicados são para 100 unidades

## 1620

terminais tipo lingueta, macho



	D mm	L mm	€		
1620R/6,3K	0,5+1,5	22	22	15,50	1 016200101
1620B/6,3K	1,5-2,5	22	22	15,50	1 016200102
1620G/6,3K	2,5-6	22	22	18,40	1 016200103

Os preços indicados são para 100 unidades

## 1622

terminais tipo clipe, fêmea

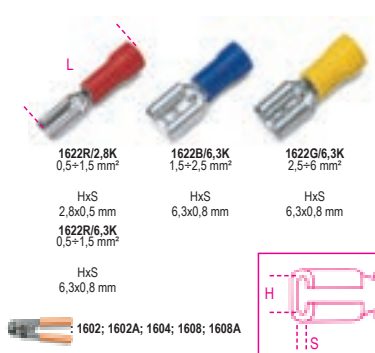

	HxS mm	L mm	€		
1622R/2,8K	2,8x0,5	20	20	14,40	1 016220101
1622R/6,3K	0,5+1,5	22	22	18,40	1 016220103
1622B/6,3K	1,5-2,5	22	22	19,50	1 016220106
1622G/6,3K	2,5-6	22	22	20,50	1 016220108

Os preços indicados são para 100 unidades

## 1624

terminais isolados tipo clipe



	HxS mm	L mm	€		
1624R/6,3K	0,5-1,5	23	23	23,80	1 016240102
1624B/6,3K	1,5-2,5	24	24	23,80	1 016240104
1624G/6,3K	2,5-6	24	24	26,00	1 016240105

Os preços indicados são para 100 unidades

## 1628

ligadores

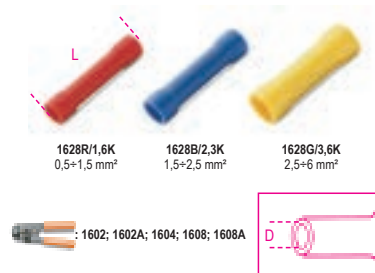

	D mm	L mm	€		
1628R/1,6K	1,6	0,5-1,5	25	18,40	1 016280101
1628B/2,3K	2,3	1,5-2,5	25	19,80	1 016280102
1628G/3,6K	3,6	2,5-6	26	31,50	1 016280103

Os preços indicados são para 100 unidades

## 1630

ligadores rápidos



	mm²	L mm	€		
1630R/K	0,5-1,5	20	20	30,00	1 016300101
1630B/K	1,5-2,5	20	20	30,00	1 016300102

Os preços indicados são para 100 unidades

## 1632

terminais

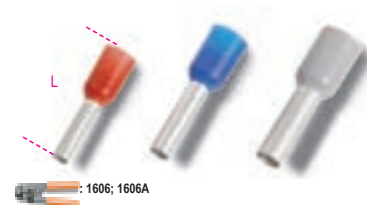

	mm²	L mm	€		
1632W/0,5K	0,5	14	14	5,05	1 016320005
1632G/0,75K	0,75	14	14	5,05	1 016320007
1632R/1K	1	14	14	5,05	1 016320010
1632N/1,5K	1,5	15	15	5,05	1 016320015
1632B/2,5K	2,5	15	15	6,00	1 016320025
1632G/4K	4	17	17	9,30	1 016320040
1632Y/6K	6	20	20	11,50	1 016320060

Os preços indicados são para 100 unidades

## 1634

terminais duplos



	mm²	L mm	€		
1634W/0,5K	0,5	15	15	8,40	1 016340005
1634G/0,75K	0,75	15	15	8,40	1 016340007
1634R/1K	1	15	15	8,40	1 016340010
1634N/1,5K	1,5	16	16	9,60	1 016340015
1634B/2,5K	2,5	19	19	10,70	1 016340025
1634G/4K	4	23	23	27,00	1 016340040
1634Y/6K	6	26	26	32,00	1 016340060

Os preços indicados são para 100 unidades

## 1639NS-N

fita de fricção, preta



L m	€		
25	5,15	10	016390025

**Beta**

## 1639S

extractor fios de nylon

com cabeças intercambiáveis



L	Ø	€		
m	mm			
10	4	18,00	1	016390010

## 1640K

puncionadora fornecida em estojo com 4 punções  
punções redondas  
22.5-25.5-32.5-55.5 mm



1640K	€		
1.495,00	1	016400001	

470x400x100 mm

## 1640

pressa furadora para chapa metálica



1640	€		
964,00	1	016400100	

## 1640A

adaptador para artigo 1640



1640A	€		
10,40	1	016400080	

## 1640P

pino roscado para artigo 1640



	Ø	€		
	mm			
1640P/9	9,5	32,50	1	016400088
1640P/19	19	37,00	1	016400089

## 1640Q

punções quadradas para artigo 1640



1640Q 45	mm	€		
45x45	647,00	1	016400065	

## 1640T

punções redondas para artigo 1640

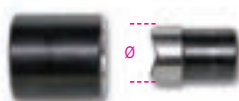

	Ø	€		
	mm			
1640T 22,5	22,5	62,00	1	016400022
1640T 25,5	25,5	80,00	1	016400025
1640T 32,5	32,5	96,50	1	016400032
1640T 55,5	55,5	125,00	1	016400055

## 1650

paquímetro leitura vigesimal



UNI EN ISO 13385-1DIN 862

A max	L	€		
mm	mm			
150	235	55,50	1	016500001
200	290	72,00	1	016500002

## 1650FD

paquímetro para discos de travões,  
leitura decimal

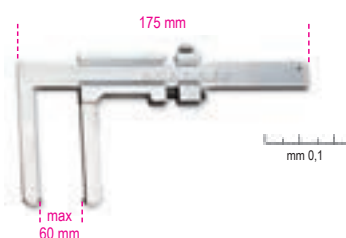

1650FD	€		
192,00	1	016500050	

## 1650FT

paquímetro para tambores de travões,  
leitura vigesimal



	A max	L	€		
	mm	mm			
1650FT/1	350	438	355,00	1	016500060
1650FT/2	500	550	627,00	1	016500070

## 1651DGT

paquímetro digital,  
leitura até 0.01 mm  
leitura até 0.0005"



UNI EN ISO 13385-1DIN 862CE

A Max	L	€		
mm	mm			
150	225	115,00	1	016510111
200	285	133,00	1	016510112

## 1651DGT/IP

paquímetro digital,  
leitura até 0.01 mm, grau de protecção IP67

Protecção total contra poeira e líquidos; funciona mesmo quando completamente imerso



UNI EN ISO 13385-1 DIN 862CE

1651DGT/IP	€		
268,00	1	016510611	

270x115x35 mm - 450 g

## 1652

paquímetro analógico  
leitura analógica quinquagesimal



UNI EN ISO 13385-1DIN 862

1652	€		
115,00	1	016520016	

## 1654

paquímetro leitura quinquagesimal



UNI EN ISO 13385-1DIN 862

A max mm	L mm	€	📦	📄
200	330	251,00	1	016540020
300	410	343,00	1	016540030

## 1654DGT

paquímetro digital, leitura até 0.01 mm  
leitura até 0.0005"

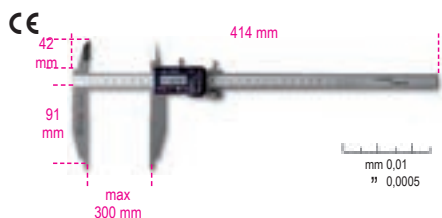

UNI EN ISO 13385-1DIN 862CE

1654DGT	€	📦	📄
	578,00	1	016540111

## 1656

paquímetro de profundidade com ponta leitura vigesimal



UNI EN ISO 13385-2DIN 862

A max mm	L mm	€	📦	📄
200	260	119,00	1	016560020
300	360	175,00	1	016560030

## 1657DGT/2

paquímetro digital de profundidade leitura centesimal

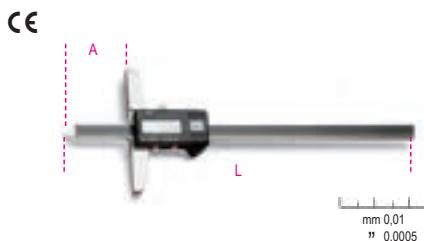

UNI EN ISO 13385-2DIN 862CE

1657DGT/2	A max mm	L mm	€	📦	📄
	200	270	223,00	1	016570002

## 1658/...

micrômetros para exteriores leitura centesimal



DIN 863/II

	A mm	€	📦	📄
1658/25	0÷25	69,00	1	016580025
1658/50	25÷50	75,50	1	016580050
1658/75	50÷75	85,50	1	016580075
1658/100	75÷100	93,00	1	016580100

## 1658/C4

jogo de 4 micrômetros modelo 1658



DIN 863

1658/C4	€	📦	📄
	273,00	1	016580001

1658/25	0÷25 mm
1658/50	25÷50 mm
1658/75	50÷75 mm
1658/100	75÷100 mm

365x245x35 mm - 2,5 kg

## 1658DGT

micrômetro exterior, leitura até 0.001 mm



DIN 863CE

	A mm	€	📦	📄
1658DGT25	0÷25	312,00	1	016580325
1658DGT50	25÷50	357,00	1	016580350

## 1658SP/1

suporte para micrômetro



1658SP/1	€	📦	📄
	47,50	1	016580910

## 1659

medidor de espessura com comparador leitura centesimal

C = campo de comparação

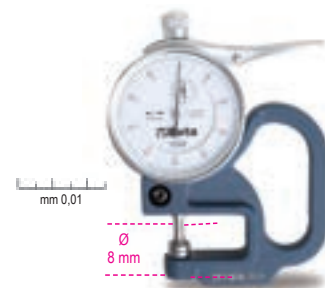

1659	C mm	€	📦	📄
	0÷10	177,00	1	016590001

## 1662/1 - 1662/2

comparador leitura centesimal

C = campo de comparação



	C mm	€	📦	📄
1662/1	0÷5	81,00	1	016620001
1662/2	0÷10	99,50	1	016620010

## 1662DGT/A

comparador digital,  
leitor para 0.01 mm  
C = Campo de leitura



C	€	1	016620311
mm 0-12,5	246,00		

## 1662AN

comparador analógico,  
com ponteira orientável,  
leitura até 0.01 mm  
Campo de leitura



DIN 2270

C	€	1	016620200
mm 0=0,8	191,00		

## 1662SP0

base magnética



€	1	016620800
68,00		

## 1662SP2

suporte com base magnética  
articulado



€	1	016620910
123,00		

## 1666

esquadro simples em aço inoxidável  
rectificado e polido



DIN 875/0

L	L1	€	1	016660210
mm 100	mm 70	56,50		
150	100	81,50		016660215
200	130	97,50		016660220
250	165	127,00		016660225
300	200	159,00		016660230

## 1666A

esquadro de ceppo em aço inoxidável  
rectificado e polido



DIN 875/0

L	L1	€	1	016660110
mm 100	mm 70	82,00		
150	100	111,00		016660115
200	130	155,00		016660120
250	170	195,00		016660125
300	200	250,00		016660130

## 1668

esquadro de ceppo  
em aço normalizado  
retificado



DIN 875/2

L	L1	€	2	016680210
mm 100	mm 70	24,60		
150	100	34,00		016680215
200	130	43,00		016680220
250	165	63,50		016680225
300	174	76,50		016680230

## 1668A

esquadro de ceppo  
em aço normalizado rectificado



DIN 875/2

L	L1	€	2	016680110
mm 100	mm 70	29,50		
150	100	45,50		016680115
200	130	57,50		016680120
250	165	82,50		016680125
300	176	98,50		016680130

## 1670

esquadros de precisão  
em aço rectificado



L	L1	€	3	016700010
mm 100	mm 70	15,30		
150	100	15,90		016700015
200	130	18,00		016700020
250	160	19,70		016700025
300	175	21,80		016700030
400	230	33,00		016700040
500	280	36,00		016700050
600	330	38,50		016700060
800	420	52,00		016700080
1000	500	62,50		016700099

# Beta

## 1670A

esquadros de cepo  
em aço rectificado



L mm	L1 mm	€	U	Art.
100	70	20,20	3	016700110
150	100	21,80	3	016700115
200	130	24,00	3	016700120
250	165	28,50	3	016700125
300	175	34,00	3	016700130
400	230	44,00	2	016700140
500	280	59,00	2	016700150
600	330	66,50	2	016700160
700	375	78,50	1	016700180
1000	500	97,50	1	016700199

## 1672

suta corrediça lâmina e base em aço

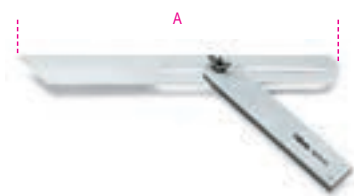

A mm	€	U	Art.
300	47,50	2	016720030

## 1672A

suta corrediça com lâmina em aço cromado  
e base em alumínio

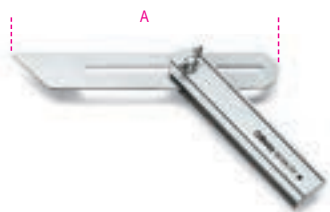

A mm	€	U	Art.
200	24,90	3	016720120
300	27,00	3	016720130

## 1674A

esquadros para marceneiro  
lâmina em aço base em alumínio,  
dupla escala milimétrica

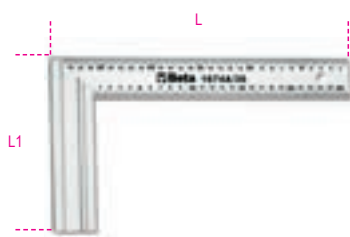

L mm	L1 mm	€	U	Art.
300	169	23,20	2	016740130
400	214	29,00	2	016740140

## 1676

goniômetros simples  
em aço inoxidável

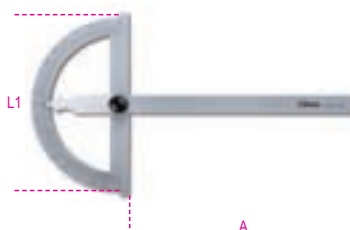

A mm	A mm	L1 mm	G mm	€	U	Art.
120	120	80	1°	37,00	2	016760012
150	165	120	1°	42,00	2	016760015
200	210	150	1°	51,00	2	016760020
300	310	200	1°	68,00	1	016760030

## 1678/C3

transferidor de ângulos  
em aço inoxidável



L Max mm	D mm	€	U	Art.	
1678/C3	300	70	257,00	1	016780030

# Beta

## 1679

paquímetro de traçagem com rolete  
em aço inoxidável, leitura decimal

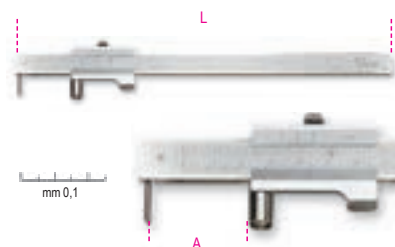

L mm	A Max mm	€	U	Art.
235	200	78,50	1	016790020

## 1679/PR

ponta sobresselente para manómetro  
universal 1679



€	U	Art.	
1679/PR	12,60	1	016790021

## 1680

compassos de vara corpo e pontas  
de traçagem em aço temperado

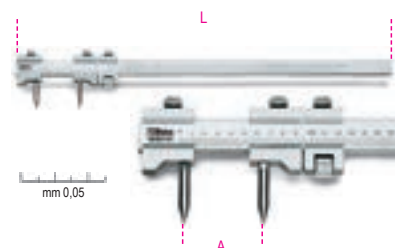

L mm	A Max mm	€	U	Art.
660	500	257,00	1	016800050

## 1680A

compassos de precisão  
para interiores



L mm	A Max mm	€	U	Art.
150	144	16,90	2	016800115
200	200	20,80	2	016800120
250	245	25,50	1	016800125
300	300	29,50	1	016800130

# Beta

# Beta

## 1680B

compassos de precisão para exteriores



L mm	A Max mm	€	📦	📄
150	155	16,90	2	016800215
200	190	20,80	2	016800220
250	235	25,50	1	016800225
300	280	29,50	1	016800230

## 1680C

compassos de precisão para traçagem pontas direitas em aço temperado



L mm	A Max mm	€	📦	📄
150	138	16,90	2	016800315
200	190	20,80	2	016800320
250	235	25,50	1	016800325
300	280	29,50	1	016800330

## 1682

réguas graduadas flexíveis em aço inoxidável

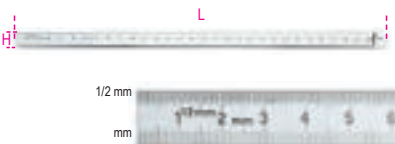

L mm	H mm	± mm	€	📦	📄
150	13	0,5	2,70	5	016820015
200	13	0,5	2,95	5	016820020
250	13	0,5	3,60	5	016820025
300	13	0,5	4,60	5	016820030
500	13	0,5	10,20	2	016820050
1000	13	0,5	26,00	2	016820100

## 1683

réguas graduadas semi-rígidas em aço inoxidável

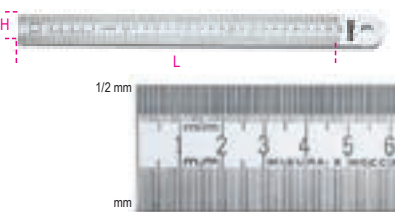

L mm	H mm	± mm	€	📦	📄
300	30	1	7,95	5	016830030
500	30	1	13,30	2	016830050
1000	30	1	34,00	2	016830100
1500	30	1	76,50	1	016830150

## 1685/C7

jogo de 7 ferramentas para medir e traçar



1685/C7	€	📦	📄
	266,00	1	016850110

1650	160 mm
1658/25	0+25 mm
1670	100 mm
1680C	150 mm
1682	150 mm
1688BC	165 mm
1688BC/R	

320x210x37 mm - 1,2 kg

## 1687A

riscador com punho para mecânico, tipo curvo a 90°



1687A	L mm	L1 mm	€	📦	📄
	153	80	5,70	1	016870120

## 1687AC

riscador com punho para mecânico, tipo curva curta a 90°

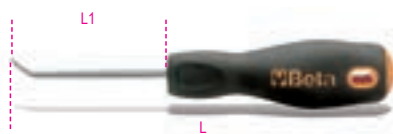

1687AC	L mm	L1 mm	€	📦	📄
	153	80	5,70	1	016870125

## 1687D

riscador com punho para mecânico, tipo direito



1687D	L mm	L1 mm	€	📦	📄
	153	80	5,70	1	016870110

## 1687U

riscador com punho para mecânico, tipo gancho



1687U	L mm	L1 mm	€	📦	📄
	153	80	5,70	1	016870115

## 1687/S4

jogo de 4 riscadores com punho para mecânico



1687/S4	€	📦	📄
1687A-1687AC 1687D-1687U	22,70	1	016870150

## 1688

riscador em aço temperado



1688	L mm	Ø mm	€	📦	📄
	250	2	7,45	5	016880020

## 1688A

riscador em aço temperado, extremidade em carbonato de tungstênio



1688A	L mm	Ø mm	€	📦	📄
	200	4	13,70	5	016880120

## 1688PC

riscador em aço temperado, com acabamento cromado



1688PC	L mm	Ø mm	€	📦	📄
	150	1	33,00	1	016880300

## 1688PC/R

ponta de substituição para artigo 1688PC



1688PC/R	€	📦	📄
	9,50	1	016880310

### 1688M

lápiz



L	mm	€	U	U
1688M	180	0,95	50	016880880

### 1690F

fita métrica feita de fibra de vidro, classe III



L	S	€	U	U
m	mm			
1690F/2	2	10,70	5	016900220

### 1690L

fita métrica feita de vidoeiro flexível, classe III



L	S	€	U	U
m	mm			
1690L/2	2	11,80	5	016900200

### 1691BM

fita métrica  
revestimento ABS de dois componentes  
resistentes ao choque,  
fita em aço,  
precisão classe II

CE



L	S	€	U	U
m	mm			
1691BM/5	5	14,10	1	016910205
1691BM/8	8	21,00	1	016910208
1691BM/10	10	25,50	1	016910210

### 1692

fitas métricas,  
caixa em ABS anti-choque,  
fitas em aço,  
classe de precisão II

CE



L	S	€	U	U
m	mm			
1692/2	2	6,80	5	016920052
1692/3	3	8,65	5	016920053
1692/5	5	12,40	5	016920055
1692/8	8	17,90	5	016920058

### 1694/L

fitas métricas longas caixa em ABS  
anti-choque, fita em fibra de vidro  
revestida a PVC, classe de precisão III



L	S	€	U	U
m	mm			
1694L10	10	11,30	1	016940110
1694L20	20	13,90	1	016940120

### 1694A/L

fita métrica com punho,  
caixa em ABS anti-choque,  
fita em fibra de vidro revestida a PVC,  
classe de precisão III



L	S	€	U	U
m	mm			
1694A/L30	30	28,00	1	016940230
1694A/L50	50	37,00	1	016940250

### 1694B/L

fitas métricas com punho caixa em ABS  
anti-choque, fita em fibra de vidro  
revestida a PVC, classe de precisão II



L	S	€	U	U
m	mm			
1694B/L50	50	56,00	1	016940350

### 1695XS

nível de bolso com base magnética em V  
em alumínio  
2 bolhas inquebráveis  
precisão: 1mm/m



L	H	S	€	U	U
mm	mm	mm			
70	48,5	20	11,50	5	016950250

### 1696

níveis com bolhas inquebráveis  
e corpo em perfil de alumínio  
anodizado – precisão: 1 mm/m



L	H	S	€	U	U
mm	mm	mm			
200	50	19	19,30	2	016960002
400	50	19	22,40	2	016960004
500	50	19	24,20	2	016960005
600	50	19	26,00	2	016960006
800	50	19	33,00	2	016960008
1000	50	19	36,00	2	016960010

### 1696A

nível em alumínio moldado sobre pressão,  
envernizado, com 1 base rectificada  
e 2 bolhas invioláveis,  
precisão de 1 mm/m



L	H	S	€	U	U
mm	mm	mm			
300	43	23	27,50	2	016960103
400	43	23	29,50	2	016960104
500	43	23	32,50	2	016960105
600	43	23	35,00	2	016960106
800	43	23	57,00	1	016960108
1000	43	23	70,50	1	016960110

### 1696B

nível magnético corpo em perfil  
de alumínio anodizado,  
2 bolhas invioláveis, precisão de 1 mm/m



L	H	S	€	U	U
mm	mm	mm			
200	49	22	30,00	2	016960202
300	49	22	32,00	2	016960203
400	49	22	33,50	2	016960204
500	49	22	40,00	2	016960205
600	49	22	42,00	2	016960206



## 1696D

níveis em alumínio anodizado com pegas, 4 bases e 3 bolhas inquebráveis, precisão: 1 mm/m

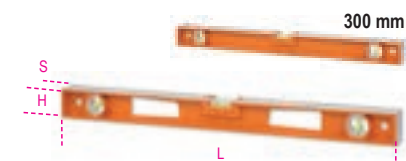

L mm	H mm	S mm	€	🔧	📦
300	47	25	26,00	2	016960353
400	47	25	29,50	2	016960354
500	47	25	32,50	2	016960355
600	47	25	36,00	2	016960356

## 1696S

níveis de pedreiro em alumínio com 2 bolhas inquebráveis precisão: 1 mm/m

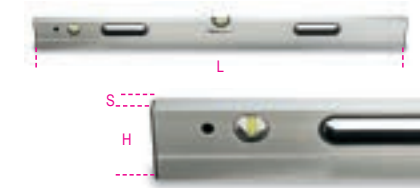

L mm	H mm	S mm	€	🔧	📦
1500	90	25	93,00	1	016960415
2000	90	25	111,00	1	016960420
2500	90	25	137,00	1	016960425
3000	90	25	155,00	1	016960430

## 1699L

nível linear de precisão em ferro fundido com base prismática rectificada, 2 bolhas invioláveis precisão de 0,05 mm/m



DIN 877

1699L	L mm	A mm	€	🔧	📦
	200	49	275,00	1	016990002

## 1699L/1

nível linear de precisão em ferro fundido com base prismática rectificada, 2 bolhas invioláveis em caixa de madeira precisão de 0,02 mm/m



DIN 877

1699L/1	L mm	A mm	€	🔧	📦
	200	49	293,00	1	016990005

## 1699Q

nível quadrado de precisão em ferro fundido com 2 bases prismáticas e 2 bases planas rectificadas e 2 bolhas invioláveis precisão de 0,05 mm/m



DIN 877

L mm	A mm	€	🔧	📦
150	40	393,00	1	016990015
200	48	489,00	1	016990020

## 1700N

ponteiros para pedreiro



L mm	S mm	€	🔧	📦
250	16	14,20	5	017000005
300	16	15,30	5	017000006

## 1700N/PM

ponteiros para pedreiro com punho de protecção



L mm	S mm	€	🔧	📦
250	16	19,10	2	017000105
300	16	21,80	2	017000106

## 1701N

cinzéis para pedreiro



L mm	A mm	S mm	€	🔧	📦
250	23	16	15,30	5	017010001
300	23	16	16,40	5	017010003

## 1701N/PM

cinzéis para pedreiro com punho de protecção



L mm	A mm	S mm	€	🔧	📦
250	23	16	19,70	2	017010101
300	23	16	21,80	2	017010103

## 1701PMR

punhos de protecção para artigos 1700N e 1701N

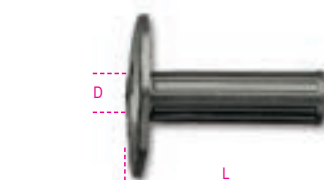

D mm	L mm	€	🔧	📦
16	115	9,30	1	017010206

## 1701NE/...

cinzéis para electricistas



	SxL mm	€	🔧	📦
1701NE3	10x200	9,30	5	017010406
1701NE4	10x250	9,85	5	017010409

## 1702N

talhadeiras largas



A mm	SxH mm	€	🔧	📦
50	12x25	19,90	2	017020005
70	12x25	20,40	2	017020007

## 1702N/PM

talhadeiras largas com punho de protecção



A mm	SxH mm	€	🔧	📦
50	12x25	24,00	2	017020105
70	12x25	26,00	2	017020107



Aconselhamos uma refrigeração constante da lâmina durante o re-afiação

## 1702PMR

punho de protecção para artigo 1702N



L mm	€	🔧	📦
115	7,10	1	017020200



## 1704

pés-de-cabra

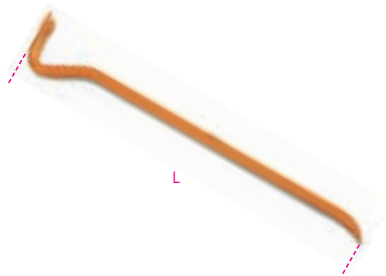

L mm	6 mm	1 mm	1 mm	€	U	IT
500	16	35	28	25,50	2	017040050
600	16	34	26	29,00	2	017040060
800	18	38	29	41,00	2	017040080

## 1704A

pés-de-cabra

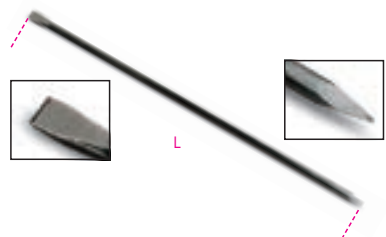

L mm	6 mm	1 mm	€	U	IT
1500	45	25	72,50	1	017040110
2000	28	55	104,00	1	017040120

## 1704C

alavanca com extremidades pontiaguda e chata fechada



L mm	8 mm	10 mm	1 mm	€	U	IT
1200	21-31	39		87,50	1	017040210
1400	31-37	42		105,50	1	017040212
1600	25-37	42		130,00	1	017040215

## 1705

traçador de linhas em alumínio



L m	€	U	IT
1705	30	16,90	4 017050001

## 1705PT

pó para traçagem



g	€	U	IT
250	10,90	5	017050025

## 1706DGT

Instrumento digital de medição da profundidade das ranhuras dos pneus



€	U	IT
32,50	1	017060011

## 1707

conta-fios

rosca métrica ISO a 60° e Whitworth a 55°



P (ISO)	W	€	U	IT
0,25÷6	62÷4x1"	15,60	5	017070001

## 1707A/1 - 2 - 3

medidor de raios, lâminas côncavas e convexas em aço

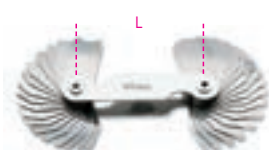

R	L	€	U	IT
1707A/1	1,0÷7,0 70 34	24,10	2	017070007
1707A/2	7,5÷15 85 32	26,00	2	017070015
1707A/3	15,5÷25 85 30	26,00	2	017070025

## 1708/8 - 13 - 20

apalpa-folgas



1708/8	€	U	IT
S = 0,05÷0,50 mm	5,85	5	017080008
1708/13	6,55	5	017080013
S = 0,05÷1,00 mm			
1708/20	10,70	5	017080020
S = 0,05÷1,00 mm			

## 1709/10 - 1709/18

quebra porcas



L	A max	€	U	IT
1709/10	90 17 (M10)	48,00	1	017090010
1709/18	108 25 (M16)	52,50	1	017090018

## 1710

quebra porcas hidráulico



C min	C max	€	U	IT
7 (M4)	22 (M14)	217,00	1	017100001

## 1712E/1 - 2 - 3

pesca peças magnético

F = força magnética



L	D	F	€	U	IT
1712E/1	420 7,5 0,5	27,50	2	017120011	
1712E/2	530 15 1,8	35,00	2	017120012	
1712E/3	532 19 3,0	43,50	2	017120013	

## 1712E/L1

pesca peças flexível magnético com luz LED

F = força magnética

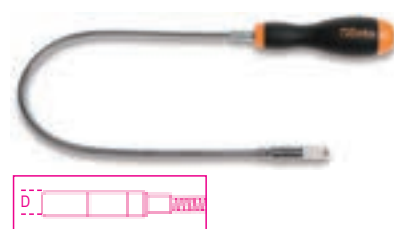

L	D	F	€	U	IT
1712E/L1	500 11 0,75	39,00	2	017120111	

### 1712E/R-L1

cabeças de substituição para artigo 1712E/L1, com LED e íman

1712E/R-L1	€ 17,50	1	017120611
------------	---------	---	-----------

### 1712TF

Iman telescópico com cabeça flexível

• Com anilha de limpeza a jacto



L mm	D mm	F kg	€		
150÷590	11	1	18,00	1	017120600

### 1713M

pesca peças magnético



L mm	D mm	€		
500	7	38,00	2	017130011
1000	7	66,50	1	017130015

### 1714

espelho de inspeção plástico



1714	L mm	D mm	€		
	155	25	3,30	5	017140001

### 1715

espelho telescópico orientável, corpo em metal cromado



1715	L mm	D mm	€		
	180÷540	30	29,00	1	017150001

### 1715FL/A

espelho quadrado



1715FL/A	L mm	A mm	B mm	€		
	600	53	90	34,50	1	017150110

### 1715R/FL

jogo de 2 espelhos de substituição para artigos 1715FL/A e 1715FL/B

1715R/FL	€		
	7,10	1	017150151

### 1715FL/B

espelho rectangular com iluminação

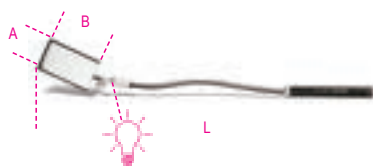

1715FL/B	L mm	A mm	B mm	€		
	553	53	90	41,50	1	017150115

### 1715B/R5L

jogo de 5 lâmpadas de substituição para artigo 1715FL/B

1715B/R5L	€		
	5,70	1	017150152

### 1716A

raspador angular para uso genérico

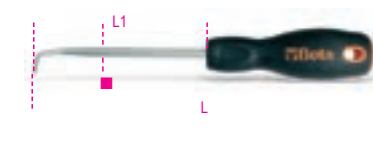

1716A	L mm	L1 mm	□ mm	€		
	240	125	6	9,85	3	017160040

### 1716P

raspador para embalagens

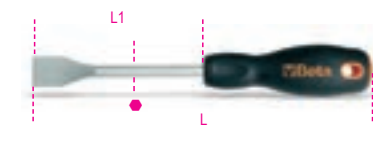

1716P	L mm	L1 mm	● mm	€		
	250	125	6	12,00	3	017160020

### 1716Q

furador com ponta quadrada

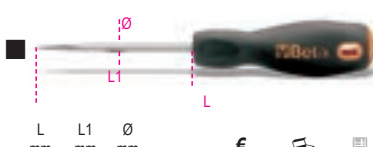

1716Q	L mm	L1 mm	∅ mm	€		
	215	100	6	8,40	5	017160010

### 1716R

furador com ponta redonda

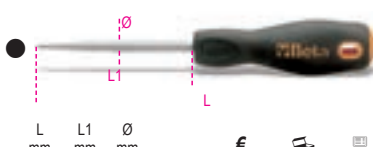

1716R	L mm	L1 mm	∅ mm	€		
	215	100	6	8,40	5	017160001

### 1716U

raspador em gancho para uso genérico

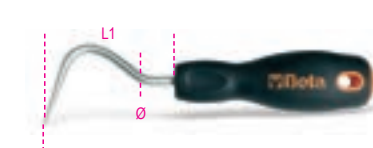

1716U	L mm	L1 mm	∅ mm	€		
	195	80	6	9,85	3	017160025

### 1717A

rascador curvo



L mm	L1 mm	L2 mm	€		
150	70	260	18,60	2	017170015
200	75	310	20,20	2	017170020
250	100	360	22,40	2	017170025

### 1717B

rascador triangular



L mm	L1 mm	L2 mm	€		
150	75	260	15,90	2	017170115
200	85	310	18,60	2	017170120
250	100	360	20,80	2	017170125

### 1717C

rascador direito



L mm	S mm	L1 mm	€		
150	18	270	15,90	2	017170215
200	20	320	18,00	2	017170220
250	25	370	20,20	2	017170225

### 1717D

rascador direito de corte frontal



1717D	L mm	S mm	L1 mm	€		
150	150	23	240	21,80	2	017170320

### 1718D...Q

limas quadradas bastardas, sem punho



1718D6/Q	L mm	L" "	€		
	150	6	8,00	5	017180121
1718D8/Q	200	8	9,60	5	017180131
1718D10/Q	250	10	13,00	5	017180141

### 1718A...Q

limas quadradas meia-murças, sem punho

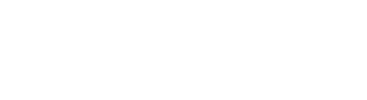

1718A6/Q	L mm	L" "	€		
	150	6	8,20	5	017180021
1718A8/Q	200	8	9,85	5	017180031
1718A10/Q	250	10	13,60	5	017180041

### 1718D...T

limas triangulares bastardas, sem punho

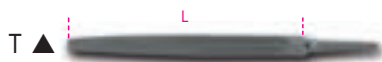

	L mm	L "	€		
1718D6/T	150	6	9,75	5	017180123
1718D8/T	200	8	12,30	5	017180133
1718D10/T	250	10	16,20	5	017180143

### 1718A...T

limas triangulares meia-murças, sem punho



	L mm	L "	€		
1718A6/T	150	6	9,85	5	017180023
1718A8/T	200	8	12,70	5	017180033
1718A10/T	250	10	17,10	5	017180043

### 1718D...P

limas chatas bastardas, sem punho



	L mm	L "	€		
1718D6/P	150	6	7,65	5	017180125
1718D8/P	200	8	8,95	5	017180135
1718D10/P	250	10	12,00	5	017180145

### 1718A...P

limas chatas meia-murças, sem punho



	L mm	L "	€		
1718A6/P	150	6	8,00	5	017180025
1718A8/P	200	8	9,20	5	017180035
1718A10/P	250	10	12,90	5	017180045

### 1718D...M

limas meia-cana bastardas, sem punho

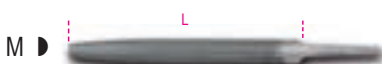

	L mm	L "	€		
1718D6/M	150	6	10,50	5	017180127
1718D8/M	200	8	13,00	5	017180137
1718D10/M	250	10	17,10	5	017180147

### 1718A...M

limas meia-cana bastardas, sem punho



	L mm	L "	€		
1718A6/M	150	6	10,90	5	017180027
1718A8/M	200	8	13,30	5	017180037
1718A10/M	250	10	17,90	5	017180047

### 1718D...R

limas redondas bastardas, sem punho



	L mm	L "	€		
1718D6/R	150	6	7,65	5	017180129
1718D8/R	200	8	8,95	5	017180139
1718D10/R	250	10	11,80	5	017180149

### 1718A...R

limas redondas meia-murças, sem punho



	L mm	L "	€		
1718A6/R	150	6	8,00	5	017180029
1718A8/R	200	8	9,20	5	017180039
1718A10/R	250	10	12,30	5	017180049

### 1718D...S5

jogo de 5 limas bastardas, sem punhos



	L mm	L "	€		
1718D6/S5	150	6	44,00	1	017180130
1718D8/S5	200	8	53,00	1	017180140
1718D10/S5	250	10	70,00	1	017180150

### 1718A...S5

jogo de 5 limas meia-murças, sem punhos

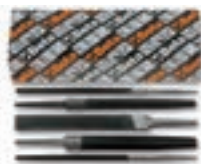

	L mm	L "	€		
1718A6/S5	150	6	45,00	1	017180030
1718A8/S5	200	8	54,00	1	017180040
1718A10/S5	250	10	74,00	1	017180050

### 1719BMD...Q

limas quadradas bastardas, com punho

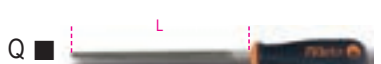

	L mm	L "	€		
1719BMD6/Q	150	6	11,40	5	017190191
1719BMD8/Q	200	8	12,60	5	017190221
1719BMD10/Q	250	10	16,70	5	017190241
1719BMD12/Q	300	12	21,80	3	017190325

### 1719BMA...Q

limas quadradas meia-murças, com punho



	L mm	L "	€		
1719BMA6/Q	150	6	11,30	5	017190021
1719BMA8/Q	200	8	13,20	5	017190052
1719BMA10/Q	250	10	17,30	5	017190071
1719BMA12/Q	300	12	26,00	3	017190311

### 1719BMX...Q

limas quadradas murças, com punho



	L mm	L "	€		
1719BMX6/Q	150	6	12,00	5	017190022
1719BMX8/Q	200	8	15,60	5	017190053
1719BMX10/Q	250	10	21,00	5	017190072

### 1719BMD...T

limas triangulares bastardas, com punho



	L mm	L "	€		
1719BMD6/T	150	6	13,10	5	017190193
1719BMD8/T	200	8	15,30	5	017190223
1719BMD10/T	250	10	19,90	5	017190243
1719BMD12/T	300	12	29,50	3	017190326

### 1719BMA...T

limas triangulares meia-murças, com punho



	L mm	L "	€		
1719BMA6/T	150	6	13,10	5	017190023
1719BMA8/T	200	8	16,30	5	017190054
1719BMA10/T	250	10	20,80	5	017190073
1719BMA12/T	300	12	31,50	3	017190313

### 1719BMX...T

limas triangulares murças, com punho



	L mm	L "	€		
1719BMX6/T	150	6	15,90	5	017190024
1719BMX8/T	200	8	20,80	5	017190055
1719BMX10/T	250	10	27,00	5	017190074

## 1719BMD...P

limas chatas bastardas, com punho



	L mm	L "	€		
1719BMD6/P	150	6	11,40	5	017190195
1719BMD8/P	200	8	11,90	5	017190225
1719BMD10/P	250	10	16,70	5	017190245
1719BMD12/P	300	12	21,50	3	017190327

## 1719BMA...P

limas chatas meia-murças, com punho



	L mm	L "	€		
1719BMA6/P	150	6	11,80	5	017190025
1719BMA8/P	200	8	13,10	5	017190056
1719BMA10/P	250	10	16,90	5	017190075
1719BMA12/P	300	12	24,80	3	017190315

## 1719BMX...P

limas chatas murças, com punho



	L mm	L "	€		
1719BMX6/P	150	6	12,00	5	017190026
1719BMX8/P	200	8	15,90	5	017190057
1719BMX10/P	250	10	20,80	5	017190076

## 1719BMD...M

limas meia-cana bastardas, com punho



	L mm	L "	€		
1719BMD6/M	150	6	14,80	5	017190197
1719BMD8/M	200	8	15,90	5	017190227
1719BMD10/M	250	10	21,40	5	017190247
1719BMD12/M	300	12	30,00	3	017190328

## 1719BMA...M

limas meia-cana meia-murças, com punho



	L mm	L "	€		
1719BMA6/M	150	6	15,30	5	017190027
1719BMA8/M	200	8	17,90	5	017190058
1719BMA10/M	250	10	22,60	5	017190077
1719BMA12/M	300	12	34,00	3	017190317

## 1719BMX...M

limas meia-cana murças, com punho



	L mm	L "	€		
1719BMX6/M	150	6	16,10	5	017190028
1719BMX8/M	200	8	20,30	5	017190059
1719BMX10/M	250	10	28,00	5	017190078

## 1719BMD...R

limas redondas bastardas, com punho



	L mm	L "	€		
1719BMD6/R	150	6	11,40	5	017190199
1719BMD8/R	200	8	11,70	5	017190229
1719BMD10/R	250	10	15,90	5	017190249
1719BMD12/R	300	12	21,50	3	017190329

## 1719BMA...R

limas redondas meia-murças, com punho



	L mm	L "	€		
1719BMA6/R	150	6	12,00	5	017190029
1719BMA8/R	200	8	13,10	5	017190060
1719BMA10/R	250	10	16,70	5	017190079
1719BMA12/R	300	12	22,50	3	017190319

## 1719BMX...R

limas redondas murças, com punho



	L mm	L "	€		
1719BMX6/R	150	6	13,70	5	017190031
1719BMX8/R	200	8	15,30	5	017190061
1719BMX10/R	250	10	20,80	5	017190081

## 1719BMD...S5

jogo de 5 limas bastardas, com punhos



	L mm	L "	€		
1719BMD6/S5	150	6	62,00	1	017190200
1719BMD8/S5	200	8	67,50	1	017190230
1719BMD10/S5	250	10	90,50	1	017190250
1719BMD12/S5	300	12	125,00	1	017190363

## 1719BMA...S5

jogo de 5 limas meia-murças, com punhos



	L mm	L "	€		
1719BMA6/S5	150	6	63,50	1	017190030
1719BMA8/S5	200	8	74,00	1	017190070
1719BMA10/S5	250	10	94,50	1	017190080
1719BMA12/S5	300	12	138,00	1	017190361

## 1719BMX...S5

jogo de 5 limas murças, com punhos



	L mm	L "	€		
1719BMX6/S5	150	6	69,50	1	017190032
1719BMX8/S5	200	8	88,00	1	017190069
1719BMX10/S5	250	10	117,00	1	017190082

## 1719BMB/P

limas chatas universais,  
punhos em material plástico



L mm	L "	€		
250	10	25,50	5	017190152
300	12	31,00	5	017190153

## 1719BMC

limas meia-cana e chatas,  
punhos em material plástico



UNI 5569 - UNI 5568

	L mm	L "	€		
1719BMC/M 250	250	10	17,30	6	017190252
1719BMC/M 300	300	12	21,50	4	017190253
1719BMC/P 250	250	10	13,60	6	017190262
1719BMC/P 300	300	12	16,70	4	017190263

## 1719BM/RR

lima redonda,  
punho em material plástico

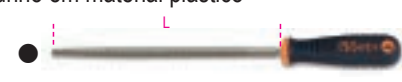

L mm	L "	€		
200	8	14,40	5	017190351

## 1719BM/RL

lima chata paralela,  
punho em material plástico



	L mm	L <sup>*</sup> mm	€	📦	🚚
1719BM/RL	200	8	13,70	5	017190360

## 1719BMR

punho para limas



	L mm	A mm	€	📦	🚚
1719BMR/0	95	25	3,20	10	017190950
1719BMR/0B	110	29	3,20	10	017190955
1719BMR/1	110	29	3,20	10	017190951
1719BMR/1B	110	29	3,20	10	017190953
1719BMR/2	123	31	3,20	10	017190952
1719BMR/2B	123	31	3,20	10	017190954

	mm	"	📦	🚚
1719BMR/0	100/150	4/6	▲▶	■●
1719BMR/0B	100/150	4/6	■●	■●
1719BMR/1	150/200	6/8	▲▶	■●
1719BMR/1B	150/200	6/8	■●	■●
1719BMR/2	250/300	10/12	▲▶	■●
1719BMR/2B	250/300	10/12	■●	■●

## 1720/...

limas de calado

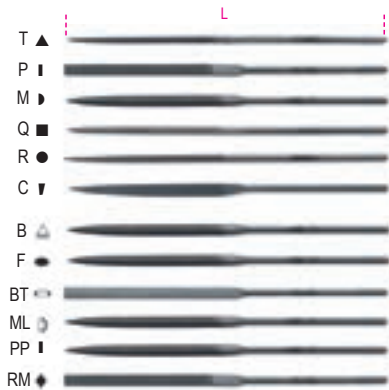

UNI 5569 UNI 5670

	L mm	€	📦	🚚
1720T	160	6,25	5	017200004
1720P	160	6,25	5	017200006
1720M	160	6,25	5	017200008
1720Q	160	6,25	5	017200009
1720R	160	6,25	5	017200010
1720C	160	6,25	5	017200012
1720B	160	6,25	5	017200005
1720ML	160	6,25	5	017200007
1720BT	160	6,25	5	017200011
1720F	160	6,25	5	017200013
1720PP	160	6,25	5	017200014
1720RM	160	6,25	5	017200015



	€	📦	🚚
1720/S3	18,70	1	017200000

## 1720/B



	€	📦	🚚
1720/B6	40,00	1	017200002
1720/B12	75,00	1	017200003

## 1720D/...

limas de calado diamantadas



	L mm	€	📦	🚚
1720D/T	160	41,50	2	017200104
1720D/P	160	41,50	2	017200106
1720D/M	160	41,50	2	017200108
1720D/Q	160	41,50	2	017200109
1720D/R	160	41,50	2	017200110
1720D/C	160	41,50	2	017200112



	€	📦	🚚
1720D/B6	251,00	1	017200120

## 1721/B6

jogo de 6 limas para contactos  
em bolsa de plástico



	€	📦	🚚
1721/B6	21,30	1	017210010

## 1723

saca-molas



	L mm	€	📦	🚚
1723	210	13,50	5	017230001

## 1725

serrote



	L mm	L1 mm	€	📦	🚚
1725	420	300	18,60	4	017250001

## 1725CR

mini serrote

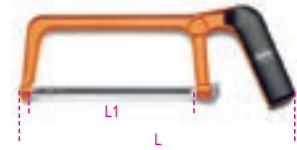

	L mm	L1 mm	€	📦	🚚
1725CR	250	150	10,30	5	017250010

## 1726

serrote, sistema tensor da folha  
incorporado no punho

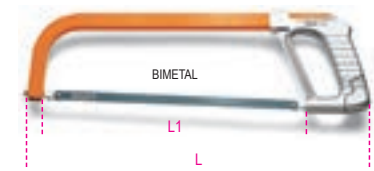

	L mm	L1 mm	€	📦	🚚
1726	440	300	25,00	4	017260001

## 1726BM

Serrote com sistema de substituição rápida da  
lâmina



	L mm	L1 mm	€	📦	🚚
1726BM	400	300	40,50	1	017260050

## 1727

serrote, série pesada

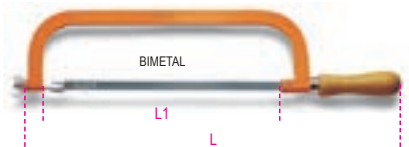

	L mm	L1 mm	€	📦	🚚
1727	515	300	17,50	4	017270001

## 1727BM

serrote,  
trabalho com uma mão



	L mm	L1 mm	€	📦	🚚
1727BM	315	300	20,80	5	017270020

## 1728...

folhas de serra

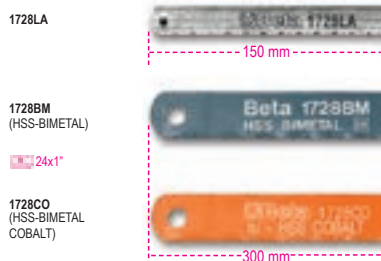

1728LA	€ 1,30	100	017280001
1725CR			
1725MQ			
1728BM	€ 3,20	100	017280010
1725-1726			
1727-1727M			
1728CO	€ 4,30	50	017280030
1725-1726			
1727-1727M			

## 1729

serrote de arco

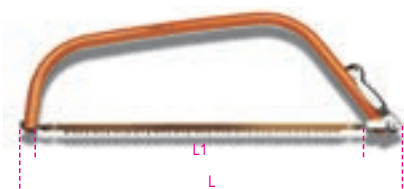

1729	L mm 710	L1 mm 610	€ 20,80	5	017290001
------	----------	-----------	---------	---	-----------

## 1729LR

folha de serra de substituição para o modelo 1729



1729LR	€ 5,25	10	017290010
--------	--------	----	-----------

## 1729CG

serra para gesso cartonado



1729CG	L mm 310	L1 mm 160	€ 20,80	2	017290200
--------	----------	-----------	---------	---	-----------

## 1729DM 450

serra para madeira

dentado médio, 12 dentes/polegadas



1729DM 450	L mm 450	L1 mm 400	€ 24,00	4	017290450
------------	----------	-----------	---------	---	-----------

## 1736A

escova de aço para limas



1736A	L mm 240	€ 9,60	10	017360010
-------	----------	--------	----	-----------

## 1737

escovas em latão



1737	L mm 145	€ 4,60	10	017370001
------	----------	--------	----	-----------

## 1737NX

escova curva em aço



1737NX	L mm 270	€ 5,45	5	017370010
--------	----------	--------	---	-----------

## 1737AC

escova em aço



1737AC	L mm 275	€ 5,15	5	017370020
--------	----------	--------	---	-----------

## 1737B

pares de escovas de limpeza de terminais e bornes de baterias



1737B	€ 12,90	1	017370050
-------	---------	---	-----------

## 1738

pincel



1738	L mm 210	H mm 30	€ 7,55	10	017380001
------	----------	---------	--------	----	-----------

## 1739B

rebitadora extensível, fornecida com 5 bicos intermutáveis



Ø mm	3,2	4	4,8	5	6	6,4
Alumínio	•	•	•	•	•	•
Aço inox	•	•	•	•		

1739B	€ 109,00	1	017390151
-------	----------	---	-----------

## 1740A

rebitadora, trabalho pesado, fornecida com 5 bicos intermutáveis



Ø mm	3,2	4	4,8	5	6	6,4
alumínio	•	•	•	•	•	•
aço inox	•	•	•	•		

1740A	€ 100,50	1	017400101
-------	----------	---	-----------

## 1740B

alicate de cravagem para trabalhos pesados, fornecido com 5 pontas intercambiáveis



Ø mm	2,4	3	3,2	3,2	4,8
alumínio	•	•	•	•	•
aço inox	•	•	•	•	•
Inox	•	•	•	•	•

1740B 280	L mm 280	€ 64,50	1	017400280
-----------	----------	---------	---	-----------

Ø mm	3,2	4	4,8	5	6	6,4
alumínio	•	•	•	•	•	•
aço inox	•	•	•	•	•	•
Inox	•	•	•	•	•	•

1740B 330	L mm 330	€ 75,50	1	017400330
-----------	----------	---------	---	-----------

## 1741B

alicate de rebitar fornecido com 4 bicos intercambiáveis



Ø mm	2,4	3,2	4	4,8	5
Alluminio	•	•	•	•	•
Aço	•	•	•	•	•
Aço inoxidável	•	•	•		

1741B € 34,50 1 017410000

## 1741B/C5

alicate de rebitar 1741B com jogo de 700 rebites em alumínio



1741B/C5 € 101,00 1 017410025

	Ø mm	L mm	n.
1741RV2,9K	3,0	6	200
1741RV3,2K	3,2	8	200
1741RV3,8K	4,0	10	100
1741RV4K	4,0	12	100
1741RV4,8K	4,8	12	100

415x155x60 mm - 3,1 Kg

## 1741BP

alicate de rebitar fornecido com 4 bicos intercambiáveis



Ø mm	2,4	3,2	4	4,8	5
Alluminio	•	•	•	•	•
Aço	•	•	•	•	•
Aço inoxidável	•	•	•		

1741BP € 51,50 1 017410350

## 1741U

alicate de rebitar compacto com força ajustável com 4 bicos intercambiáveis  
3 pernas: melhor fixação do rebite



Ø mm	2,4	3	3,2	4	4,8
Alumínio	•	•	•	•	•
Aço	•	•	•	•	•
Aço inoxidável	•	•	•		

1741U € 40,50 1 017410450

## 1741RV...K

rebites em alumínio

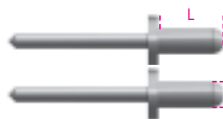

	€	1	017410191
1741RV 2,9K ØxL = 3x6 mm	15,90	1	017410191
1741RV 3,2K ØxL = 3,2x8 mm	16,40	1	017410192
1741RV 3,8K ØxL = 4x10 mm	20,80	1	017410193
1741RV 4K ØxL = 4x12 mm	22,90	1	017410194
1741RV 4,8K ØxL = 4,8x12 mm	28,50	1	017410195

## 1742

alicate ajustável de cravar porcas, com 4 bicos intercambiáveis



1742 € 114,00 1 017420001

M	Ø mm	L mm
3	5	11
4	6	11
5	7	13
6	9	17

**Beta**

## 1742KR

kit com bicos de substituição (conj.4 por medida) para substituição para a referência 1742



	€	1	017420043
M3	43,50	1	017420043
M4	43,50	1	017420044
M5	43,50	1	017420045
M6	43,50	1	017420046

## 1742R-AL/M...

rebites roscados em alumínio para itens 1742-1742A-1946KF



	€	1	017420023
1742R-AL M3 ØxL = 5x10 mm M = 3	3,95	1	017420023
1742R-AL M4 ØxL = 6x12 mm M = 4	4,05	1	017420024
1742R-AL M5 ØxL = 7x13 mm M = 5	4,40	1	017420025
1742R-AL M6 ØxL = 9x15 mm M = 6	5,25	1	017420026

## 1742R-A/M...

rebites roscados em aço para itens 1742-1742A-1946KF



	€	1	017420013
1742R-A M3 ØxL = 5x11 mm M = 3	4,15	1	017420013
1742R-A M4 ØxL = 6x11 mm M = 4	4,30	1	017420014
1742R-A M5 ØxL = 7x13 mm M = 5	4,60	1	017420015
1742R-A M6 ØxL = 9x17 mm M = 6	5,35	1	017420016
• 1742R-A M8 ØxL = 11x17 mm M = 8	5,25	1	017420018
• 1742R-A M10 ØxL = 13x24 mm M = 10	6,15	1	017420020

## 1742/C4

alicate de cravar 1742 com jogo de 400 porcas em aço



1742/C4 € 242,00 1 017420005

	M	∅ mm	n.
1742R-A/M3	3	5	100
1742R-A/M4	4	6	100
1742R-A/M5	5	7	100
1742R-A/M6	6	9	100

415x155x60 mm - 2,9 kg

## 1742A

alicate de cravar porcas para trabalhos pesados com 4 bicos intermutáveis



1742A € 423,00 1 017420100

M	∅ mm	L mm
5	7	13
6	9	17
8	11	17
10	13	24

## 1742A/KR

kit com bicos de substituição (conj.4 por medida) para artigo 1742A



M5



M6



M8



M10

	M	∅ mm	L mm	€	1	017420143
1742A/KR M5	M5			29,50	1	017420143
1742A/KR M6	M6			29,50	1	017420144
1742A/KR M8	M8			29,50	1	017420145
1742A/KR M10	M10			29,50	1	017420146

## 1742A/C

alicate de cravar porcas 1742A com jogo de 60 porcas em aço



1742A/C € 458,00 1 017420105

	M	∅ mm	n.
1742R-A/M5	5	7	20
1742R-A/M6	6	9	20
1742R-A/M8	8	11	10
1742R-A/M10	10	13	10

536x310x80 mm - 2,1 kg

## 1743

alicate para abraçadeiras em Nylon

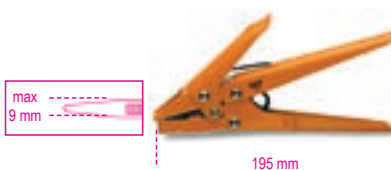

1743 € 49,50 1 017430001

## 1743T

Tesoura para abraçadeiras

• Também adequada para corte de pequenos cabos (3x1.5mm<sup>2</sup>; 1x17mm<sup>2</sup>)



1743T € 28,50 1 017430100

## 1748/...K

abraçadeiras em Nylon com cabeça autoblocante

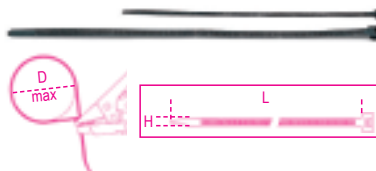

	€	1	017480203
1748/3K HxL = 2,5x100 mm D = 18 mm	4,60	1	017480203
1748/6K HxL = 2,5x160 mm D = 40 mm	9,30	1	017480206
1748/7K HxL = 3,6x150 mm D = 33 mm	10,70	1	017480207
1748/8K HxL = 3,6x200 mm D = 46 mm	10,90	1	017480208
1748/9K HxL = 3,6x300 mm D = 70 mm	14,80	1	017480209
1748/14K HxL = 4,8x190 mm D = 43 mm	17,70	1	017480214

1748/17K HxL = 4,8x300 mm D = 72 mm	19,10	1	017480217
1748/18K HxL = 4,8x360 mm D = 85 mm	22,40	1	017480218
1748/23K HxL = 7,6x300 mm D = 67 mm	38,00	1	017480223
1748/24K HxL = 7,6x368 mm D = 88 mm	43,50	1	017480224

## 1748B/...K

abraçadeiras em nylon, brancas



	€	1	017480303
1748B/3K HxL = 2,5x100 mm D = 18 mm	4,60	1	017480303
1748B/6K HxL = 2,5x160 mm D = 40 mm	9,30	1	017480306
1748B/7K HxL = 3,6x150 mm D = 38 mm	10,70	1	017480307
1748B/8K HxL = 3,6x200 mm D = 46 mm	10,90	1	017480308
1748B/9K HxL = 3,6x300 mm D = 70 mm	14,80	1	017480309
1748B/14K HxL = 4,8x190 mm D = 44 mm	17,70	1	017480314
1748B/17K HxL = 4,8x300 mm D = 72 mm	19,10	1	017480317
1748B/18K HxL = 4,8x360 mm D = 86 mm	22,40	1	017480318

## 1749

pistola para isolantes envernizada



1749 L min 340 mm € 12,00 2 017490001





## 1749A

pistola para isolantes  
modelo profissional, corpo em alumínio



	L min mm	€		
1749A	360	38,00	1	017490010

## 1749A/RB

câmara de substituição para artigo 1749A

	€		
1749A/RB	0,85	2	017490051

## 1749A/RT

placa de pressão para artigo 1749A

	€		
1749A/RT	1,90	1	017490052

## 1749AC

pistola injectora para produtos químicos



	L min mm	€		
1749AC	360	34,00	1	017490005

## 1750

pistola de massa



1 g, 550 bar Max

cc	L mm	€		
500	380	37,50	1	017500500
750	450	44,50	1	017500750

## 1750R/1 - 1750R/2

tubos flexíveis de substituição Nylon



	L mm	€		
1750R/1	310	5,90	2	017500030
1750R/2	410	6,55	2	017500040

## 1750RC

ponteira rígida curva



	L mm	M mm	€		
1750RC	150	10x1	4,80	2	017500050

## 1750RT

ponteira de lubrificação  
com 4 garras modelo hidráulico



	M mm	€		
1750RT	10x1	4,30	5	017500110

## 1750RP/1 - 1750RP/2

acoplamentos para ligações planas

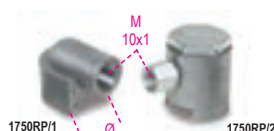

	Ø mm	M mm	€		
1750RP/1	16	10x1	10,70	2	017500115
1750RP/2	22	10x1	24,60	2	017500120

## 1750CG

cartuchos de massa para refª. 1750



cc	€		
400	13,00	18	017500140
600	16,40	18	017500160

## 1750KG10

Bomba de massa com balde de 10 kg  
com mangueira de alta pressão, 2 m

- Fornecido com união giratória, para evitar o estrangulamento da mangueira
- Bomba em alumínio fundido com válvula de retenção

3 níveis de pressão disponíveis:

- 4 g - 275 bar
- 7 g - 206 bar
- 9 g - 137 bar



	€		
1750KG10	168,00	1	017500100

## 1750TA

Bico de alta pressão com bloqueio através de 6 pinos

Uma vez posicionado, permanece no eixo e conectado ao copo; não precisa de ser mantido como um bico comum  
Fácil de desconectar mesmo sob pressão  
Rosca intermediária universal M10x1: adequada para todos os tipos de pistolas de massa: elétrica, pneumática, manual etc.  
Sem deformação até 550 bar



	€		
1750TA	39,50	1	017500111

## 1750M

mini pistola de massa

- Com micro bocal
- Particularmente adequada para ferramentas pneumáticas



	cc	D mm	L mm	€		
1750M	100	43	145	19,70	1	017500025

## 1751

almotolias metálicas bico flexível



cc	D mm	L mm	€		
200	62	140	14,10	4	017510002
300	75	140	15,20	4	017510003
500	85	140	15,90	4	017510005
750	100	140	17,50	2	017510007
1000	100	140	18,80	2	017510011

## 1751R

bico de substituição para refª. 1751



	€		
200÷1000	4,15	5	017510010

## 1752

almotolias plásticas bico rígido



cc	D mm	L mm	€	📦	📄
200	67	140	9,20	4	017520002
300	77	140	9,75	4	017520003
500	95	140	10,20	4	017520005
700	95	140	10,90	2	017520007

## 1752R

bico de substituição para refª. 1752



cc	€	📦	📄
200÷700	3,60	5	017520020

## 1753

almotolias plástica bico flexível



cc	D mm	L mm	€	📦	📄
200	65	190	9,30	4	017530002
300	80	190	9,50	4	017530003
500	95	190	9,85	4	017530005
700	95	190	10,60	2	017530007

## 1753R

bico de substituição para refª. 1753



cc	€	📦	📄
200÷700	3,75	5	017530020

## 1754

almotolias plásticas bico flexível



cc	D mm	L mm	€	📦	📄
150	60	130	7,85	5	017540015
250	65	130	8,65	5	017540025

## 1755

oleadores em plástico bico retráctil



cc	L mm	A mm	€	📦	📄
30	160	30	6,15	5	017550003
80	170	47	6,80	5	017550008
150	230	58	7,55	5	017550015

## 1756

oleador tipo caneta



cc	L mm	€	📦	📄
5	140	19,90	2	017560001

## 1756B

oleador tipo caneta



cc	L mm	€	📦	📄
500	280	19,10	2	017560220

# Beta

# Beta

## 1756C

oleador tipo caneta, 200 ml, em polipropileno

- Adequado para fluido dos travões
- Junta dupla EPDM
- Temperatura de funcionamento: +0 - +50 °C
- NÃO adequado para combustível



1756C	€	📦	📄
	31,00	1	017560502

## 1756D

oleador tipo caneta, 1500 ml, em polipropileno

- Junta dupla NBR
- Temperatura de funcionamento: +0 - +50 °C
- NÃO adequado para combustível

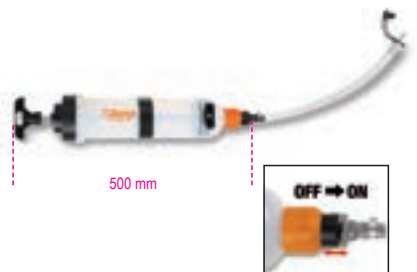

1756D	€	📦	📄
	68,50	1	017560515

## 1756C-20R

O-rings (par) para oleadores 1756C

1756C-20R	€	📦	📄
	3,85	1	017560503

## 1756D-20R

O-rings (par) para oleadores 1756D

1756D-20R	€	📦	📄
	6,00	1	017560516

## 1757

reservatório para líquido de baterias



cc	D mm	€	U	IT
250	60	3,10	4	017570002
500	75	3,60	4	017570004
1000	90	4,95	2	017570006

## 1757A

reservatório para líquido de baterias



cc	€	U	IT
2000	37,50	1	017570020

## 1758

funil adaptável

Particularmente útil para veículos sem profundidade nos bujões



1758	€ 47,50	U 1	IT 017580020
------	---------	-----	--------------

## 1758A

funil de não-retorno com encaixe rápido, Ø 38 mm  
Para veículos do grupo Volkswagen



1758A	€ 73,50	U 1	IT 017580010
-------	---------	-----	--------------

## 1758LG

folha de alumínio moldável, com revestimento em borracha, para canalização de líquidos



L mm	H mm	€	U	IT
365	168	40,50	1	017580006

## 1758M

Funil



L mm	€	U	IT
1758M 350	12,00	1	017580000

## 1758R

reservatório para líquidos

Bico flexível, amovível e prático



	lt	€	U	IT
1758R 3	3	15,70	1	017580203
1758R 5	5	19,10	1	017580205

## 1758VT

kit de teste para cabeça do cilindro

Indica num curto espaço de tempo se o tanque de expansão contém dióxido de carbono.



1758VT	€ 153,00	U 1	IT 017580100
--------	----------	-----	--------------

290x190x50 mm - 1 kg

## 1758VT/L

líquido de teste para cabeça do cilindro



1758VT/L	€ 44,00	U 1	IT 017580101
----------	---------	-----	--------------

## 1759

dispositivo óptico para análise de refrigerantes, baterias, limpa-vidros e fluidos AdBlue®

Fornecido em estojo rígido

Compensação automática de temperatura

Acido de bateria: intervalo de medição:

1.1÷1.3 kg/l

Refrigerante propileno: -25 °C ÷ -50 °C

Refrigerante etileno: -25 °C ÷ -50 °C

Limpa-vidros: -25 °C ÷ -40 °C

AdBlue: medição percentagem de ureia: 30% ÷ 45%



1759	€ 140,00	U 1	IT 017590251
------	----------	-----	--------------

# Beta

## 1759A

densímetro para líquido anti-congelante



1759A	L mm	€	1	017590001
	340	60,00		

## 1759B

densímetro para líquido de baterias



1759B	L mm	€	1	017590005
	280	39,50		

## 1759HD/3

Kit ferramentas para detecção de fugas e enchimento rápido de sistemas de refrigeração

• Para detecção de fugas do circuito de refrigeração (tubos, juntas, bombas, radiadores) e enchimento rápido, prevenindo a formação de bolhas de ar



1759HD/3	€	1	017590063
	507,00		
600x500x140 mm - 6,5 kg			

## 1759HD/RR

aparelho de teste de fugas de sistemas de arrefecimento



1759HD/RR	€	1	017590064
	155,00		
450x310x110 mm - 2,2 kg			

## 1759HD/TRUCK

ferramenta de teste e vedante para sistema de refrigeração em veículos pesados



1759HD/TRUCK	€	1	017590065
	349,00		
440x330x100 mm - 3 kg			

## 1759TT

Kit de 4 pares de tampões para detecção de fugas no turbo para utilização com punho de encher pneus



1759TT	€	1	017590300
	184,00		
400x160x100 mm - 1,8 kg			

## 1760DGT

multímetro digital auto



### CARACTERÍSTICAS TÉCNICAS

RPM (tacómetro):  
Para motores de 2 e 4 cilindros  
RPM4 600 - 4000 RPM  
RPM4 600 - 12000 RPM (x10 RPM)  
RPM2/DIS 300 - 4000 RPM  
RPM2/DIS 300 - 6000 RPM (x10 RPM)  
Ângulo excêntrico: 4-8 CYL  
Tensão DC: 400mV-4/40/400/1000V  
Tensão AC: 4/40/400/700V  
Corrente DC: 40/400mA-4/20A  
Corrente AC: 40/400mA-4/20A  
Resistência: 400Ω-4/40/400kΩ-4/40MΩ  
Capacidade: 40/400nF-4/40/100μF  
Frequência: 5/50/500Hz-50/500-10MHz  
Ciclo de trabalho: 0.1% - 99.9%  
Amplitude de impactos: 1 - 10ms  
Teste diodo: Corrente de teste 0.3mA  
Continuidade: <150Ω - Corrente de teste <0.3mA  
Visor: Alto-contraste, backlit 4-digit LCD  
Sobrevoltagem: Categoria II 1000V  
Encerramento automático: 30 minutos  
Alimentação: 1 bateria 9V (incluída)  
Pinça de indução (incluída)  
2 ponteiros (incluídas)  
Estojo em tecido macio (incluído)  
Manual de instruções

1760DGT	€	1	017600005
	235,00		

## 1760B

multímetro digital



### ESPECIFICAÇÕES

Voltagem DC: 200 mV-2/20/200/1000V  
 Voltagem AC: 2-20/200/700V  
 Corrente DC: 2/20/200 mA-20 A  
 Corrente AC: 2/200 mA- 20 A  
 Resistência: 200Ω - 2/20/200 kΩ - 2/20 MΩ  
 Capacidade: 2/20/200 nF - 2/200 μF  
 Temperatura: -20° + 1000°C/ -4 °F ~ +2000°F  
 Frequência: 20kHz  
 Potência de alimentação: Pilha 1.9V (incluída)

1760B € 150,00 1 017600012

## 1760/OHM

Multímetro/megômetro para teste de isolamento de alta tensão.  
 Indicador TRUE RMS



Amplitude de medição

Precisão  
 Voltagem AC/DC: 50mV - 1000V ±0.06% - ±0.1% rdg  
 Corrente AC/DC: 0.01μA - 10A ±0.5% - ±1% rdg  
 Resistência: 0.01Ω - 50MΩ ±0.2% - ±2% rdg  
 Meg OHM: 0.01 - 5000MΩ ±4% rdg. corrente máx. 1mA  
 Capacitância: 5nF - 10mF ±1.5% - ±3% rdg  
 Frequência: 50Hz - 100 MHz ±0.02% - ±0.1% rdg  
 Temperatura: -50 °C - +1350 °C ±0.5% rdg  
 Teste de diodo: 3V dc  
 Teste de continuidade: <30 Ω

1760/OHM € 720,00 1 017600025

## 1760/RMS

multímetro digital industrial



Tipo de leitura Precisão  
 Voltagem AC/DC 110mV - 600V ±0.8% - ±2% rdg  
 Corrente AC/DC 110μA - 10A ±1.5% - ±2% rdg  
 Resistência 110Ω - 40MΩ ±1.2% - ±2.5% rdg  
 Capacitância 11nF - 40mF ±5% - ±10% rdg (até 11mF)  
 Frequência 1100Hz - 110 MHz ±1.2% - ±1.5% rdg  
 Temperatura -32°C - +1000°C ±3% - ±5% rdg  
 Teste de diodo, 3V DC ±10% rdg  
 Teste de continuidade <30 Ω -

1760/RMS € 261,00 1 017600020

## 1760PA/80

pinça amperimétrica AC/DC, 80A

Para medir fugas de baixa corrente ou valores de absorção em veículos



- Alcance: 1mA-80A AC/DC
- Função lanterna com LED branco
- Visor LCD com retro-iluminação
- Função de reposição a zero
- Função de memorização
- Desliga-se automaticamente
- Alimentação: 2 pilhas 1.5V AAA

1760PA/80 € 193,00 1 017600002



## 1760PA/AC

pinça amperimétrica e multímetro digital

A: AC  
 V: AC/DC



### ESPECIFICAÇÕES

Voltagem DC: 400 mV - 4/40/400/600 V  
 Voltagem CA: 400 mV - 4/40/400/600 V  
 Corrente CA: 40/400/1000 A  
 Resistência: 400Ω - 4/40/400 kΩ - 4/40 MΩ  
 Frequência: 5/50/500 Hz - 5/50/500 kHz - 5/10 MHz  
 Capacidade: 40/400 nF - 4/40/100 μF  
 Temperatura: -20 °C + 1000 °C / -4 °F + 1832 °F  
 Alimentação: 1 bateria de 9V (incluída)

1760PA/AC L 190 mm € 160,00 1 017600050

## 1760PA/AC-DC

pinça amperimétrica e multímetro

A: AC/DC  
 V: AC/DC



A: AC/DC  
 V: AC/DC

### ESPECIFICAÇÕES

Voltagem DC: 0.1mV + 600V  
 Voltagem AC: 0.1mV + 600V  
 Corrente AC: 0.01A + 1000A  
 Corrente DC: 0.01A + 1000A  
 Resistência: 0.1Ω + 40MΩ  
 Capacidade: 0.001nF + 40 μF  
 Frequência: 0.001kHz + 4kHz  
 Temperatura: -40°C + 1000 °C  
 -40°F + 1832°F

1760PA/AC-DC € 288,00 1 017600000

## 1760DGT-R3

Cabos de substituição para multimetros digitais e braçadeiras amperométricas



1760DGT-R3

€ 20,80



1

017600603

## 1760/TC2

tacómetro digital combinado



CE

### DADOS TÉCNICOS

- Para medições de:
  - rotações (rpm) à distância
  - rotações (rpm) por contacto
  - e velocidade linear (m/min ou ft/min)
- Visor LCD de 5-dígitos
- Escala:
  - rotação à distância 2.5+99.999 rpm
  - rotação por contacto 0.5+19.999 rpm
  - velocidade linear 0.05+1.999.9 m/min
- Frequência: 0.8 seg
- Alimentação: 4 pilhas 1.5V, tamanho AA, ou unidade de alimentação de 6V (não incluída)
- Fornecido com:
  - adaptador para medir por contacto;
  - ponteira macho (contacto) em borracha (2 peças);
  - ponteira fêmea (contacto) em borracha (1 peça);
  - fita medição linear (1 peça);
  - etiquetas reflectoras;
  - manual de instruções;
  - caixa plástica

1760/TC2

L mm 230  
H mm 74

€ 203,00



1

017600161

## 1760R/TC2

jogo de etiquetas reflectoras para artigo 1760/TC2



1760R/TC2

€ 18,60



1

017600561

## 1760K

detector de voltagem AC sem contacto, com mini-tocha LED

Intervalo de teste: 200-1000Vac 50/60Hz  
CAT III-1000V  
Utiliza 2 pilhas AAA (incluídas)



CE  
CAT III-1000V

1760K

€ 33,00



1

017600140

## 1760PT

ferramenta de teste de tensão e continuidade, 12-690V AC/DC

- Funcões:
- continuidade
  - rotação de fases
  - corrente
  - tocha LED

CE



L=1 m

12+690V AC/DC

IP64  
CATIV  
- 600V ;  
CATIII -  
1000V

1760PT

€ 130,00



1

017600150

## 1760/IR800

termómetro digital de infravermelhos com sistema de apontamento duplo laser



CE

### Dados técnicos

Capacidade de medição: -50 °C a +800 °C / -58 °F a +1472 °F  
Seleção escala: °C/°F  
Precisão: ±1.0% or ±1.0 °C a 20 °C  
Potência do laser: <1mW  
Tempo de resposta: 150ms  
Emissividade: 0.10-1.0 ajustável  
Relação distância: (D:S) 20:1  
Temperatura de operação: 0 °C + 50 °C / 32 °F + 122 °F  
Humidade de operação: 10% a 90% RH  
Visor LCD em Backlit  
Função de armazenamento  
Auto-desligar  
Alimentação: 1,9V pilha (incluída)  
Estojo em tecido macio (incluída)  
Manual de instruções

1760/IR800

€ 280,00



1

017600380

## 1760/IR1600

termómetro digital de infravermelhos com sistema de apontamento laser



CE

### Dados técnicos

Capacidade de medição:  
-50 °C a +1600 °C / -58 °F to +2912 °F  
Seleção escala: °C/°F  
Precisão: ±1.5% or ±2 °C a 20 °C  
Potência do laser: <1mW  
Tempo de resposta: 1sec  
Emissividade: 0.10-1.0 ajustável  
Relação distância: (D:S) 50:1  
Temperatura de operação: 0 °C + 50 °C / 32 °F + 122 °F  
Humidade de operação: 10% a 90% RH  
Visor LCD em Backlit  
Função de armazenamento  
Auto-desligar  
Alimentação: 1,9V pilha (incluída)  
Estojo em alumínio  
Manual de instruções

1760/IR1600

€ 718,00



1

017600460

## 1761

alicate torce-aramo com retorno automático



L mm 255

€ 57,50



1

017610101

## 1761RS/1

alicate torce-aramo reversível com retorno automático



L mm 220

€ 102,50



1

017610130

**1762**  
alicate vazador



∅ mm	L mm	€	🔧	📦
2-2,5-3	210	26,00	2	017620001
3,5-4-4,5				

**1763**  
Alicate para agrafos de estofos auto



1763	€	🔧	📦
	28,50	1	017630001

**1763G/S500**  
500 agrafos para estofos auto



1763G/S500	€	🔧	📦
	59,00	1	017630105

**1765/C24**  
caixa com 24 ferramentas para extracção de auto-rádios



1765/C24	€	🔧	📦
	174,00	1	017650001

**1766**  
ventosa dupla

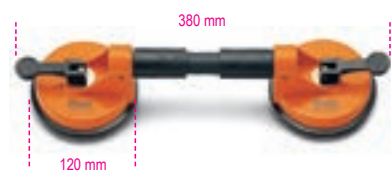

max kg	€	🔧	📦
50	108,50	2	017660001

**1766A**  
ventosa simples



max kg	€	🔧	📦
30	27,00	2	017660005

**1766/8**  
jogo de 8 ferramentas para vidros de viaturas



1766/8	€	🔧	📦
	402,00	1	017660100

**1766ER**  
ferramenta remoção de frisos das portas, com pega

Fácil remoção de frisos, sem risco de quebras



1766ER	€	🔧	📦
	19,10	1	017660501

**1766L**  
alavanca para vidros



1766L	€	🔧	📦
	45,00	1	017660015

**1766LI**  
alavanca para inserção de cabo para corte de vidros em automóveis  
arestas de corte afiadas



1766LI	€	🔧	📦
	15,30	1	017660016

**1766I**  
punhos para cabo de aço para vidros refª. 1766G

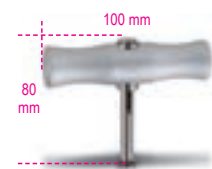

1766I	€	🔧	📦
	43,50	2	017660020

**1766G**  
cabo de aço para vidros

Secção quadrada



50 m	€	🔧	📦
	38,50	1	017660025

**1766T**  
cabo de aço para janelas de vidro

secção triangular



50 m	€	🔧	📦
	45,00	1	017660026

## 1767A

Apoio telescópico

- Projetado para suportar os capôs e tampas de mala com pistons descompactados.
- Pode ser utilizada para impedir que os pedais se movimentem.



L mm 640 ± 1090 € 60,50 1 017670000

## 1767PMC

suporte de ferramentas magnético, redondo



1767PMC € 18,60 1 017670020

## 1767PMR

suporte de ferramentas magnético, rectangular



1767PMR € 38,50 1 017670010

## 1770

x-acto plano fornecido com 2 lâminas de substituição



1770 L mm 140 A mm 9 € 14,90 10 017700001

## 1770A

x-acto 9 mm com bloqueio automático lâmina 3 lâminas de substituição



1770A L mm 135 A mm 9 € 5,45 10 017700025

## 1770RL

10 lâminas divisível de 9 mm para refª. 1770 e 1770F



1770RL € 4,80 5 017700010

## 1770BM

X-acto, 9 mm, com bloqueio automático da lâmina, 6 lâminas de substituição



1770BM L mm 140 A mm 9 € 11,50 10 017700050

## 1771

x-acto, 18 mm, fornecido com 3 lâminas



1771 € 8,40 10 017710000

## 1771BM

x-acto com 6 lâminas de substituição bi-material



1771BM L mm 170 A mm 18 € 18,50 10 017710050

## 1771RL

10 lâminas divisível de 18 mm para x-acto refª. 1771, 1771BM



1771RL € 7,00 5 017710010

## 1772M

x-acto de segurança com lâmina retrátil, fornecido com 4 lâminas

- Lâmina retrátil através de mecanismo de mola automática
- Corpo em liga de alumínio fundido
- Removedor de agrafes integrado no punho



1772M L mm 170 A mm 18 € 16,40 5 017720040

## 1772R

x-acto com lâmina trapezoidal retrátil, fornecido com 5 lâminas



1772R L mm 125 A mm 18 € 15,50 5 017720006

## 1772H

x-acto de lâmina retrátil, de segurança, lâmina de substituição



1772H L mm 170 A mm 18 € 16,30 5 017720029

## 1772RL/2

10 lâminas trapezoidais de substituição longas, em caixa, para x-actos, 1772H, 1772M, 1772R, 1774, 1777BMT, 1777T

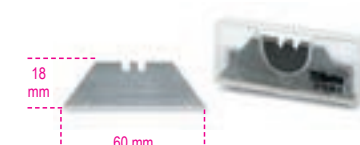

1772RL/2 € 3,95 5 017720017

## 1773A

x-acto



1773A L mm 180 A mm 25 € 16,30 10 017730000



### 1773RL

10 lâminas divisível de 25 mm para x-acto refª. 1773



1773RL	€ 15,90	5	017730015
--------	---------	---	-----------

### 1774

raspador com resguardo de protecção



1774	L mm 165	L1 mm 60	€ 3,60	5	017740001
------	----------	----------	--------	---	-----------

### 1774A

raspador multifuncional, com punho bi-material



1774A	L mm 300	L1 mm 40	€ 11,50	1	017740011
-------	----------	----------	---------	---	-----------

### 1774A/RL

10 lâminas para raspador multi-funções 1774A

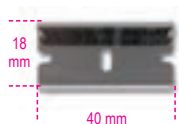

1774A/RL	€ 5,45	1	017740511
----------	--------	---	-----------

### 1777BM

navalha com lâmina em aço inoxidável e entalhe para descarnar



1777BM	L mm 190	L1 mm 80	A mm 16	€ 10,20	5	017770100
--------	----------	----------	---------	---------	---	-----------

### 1777T

navalha com lâmina trapezoidal em aço, com 5 lâminas de substituição



1777T	L mm 160	A mm 19	L1 mm 65	€ 22,90	5	017770030
-------	----------	---------	----------	---------	---	-----------

### 1777BMT

canivete com lâmina trapezoidal rebatível 4 posições ajustáveis da lâmina 4; 9.5; 15.5; 21.5 mm fornecido com 3 lâminas



1777BMT	L mm 170	L1 mm 80	A mm 19	€ 24,60	5	017770050
---------	----------	----------	---------	---------	---	-----------

### 1778CM

canivete camuflado, lâmina em aço reforçado, fornecido em estojo



1778CM	L mm 195	A mm 24	L1 mm 80	€ 29,00	5	017780099
--------	----------	---------	----------	---------	---	-----------

### 1778D

canivete, punho e lâmina em aço inoxidável, fornecida em bolsa



1778D	L mm 180	A mm 22	L1 mm 78	€ 31,00	5	017780060
-------	----------	---------	----------	---------	---	-----------

### 1778SCL

canivete acabamento macio, lâmina em aço reforçado, fornecido em estojo



1778SCL	L mm 180	A mm 22	L1 mm 78	€ 27,50	5	017780089
---------	----------	---------	----------	---------	---	-----------

### 1778SOS

navalha manutenção automóvel com quebra-janelas e cortante para cintos de segurança fornecida em bolsa



1778SOS	L mm 205	A mm 25	L1 mm 85	€ 29,50	5	017780080
---------	----------	---------	----------	---------	---	-----------

### 1778V18

canivete, punho em alumínio • fornecido em bolsa



1778V18	L mm 195	A mm 25	L1 mm 85	€ 27,50	5	017780018
---------	----------	---------	----------	---------	---	-----------

### 1778W

canivete, lâmina em aço inoxidável, punho com aplicações em madeira, fornecido em bolsa



1778W	L mm 180	A mm 22	L1 mm 78	€ 31,50	5	017780025
-------	----------	---------	----------	---------	---	-----------

### 1778X

navalhas para manutenção náutica, lâminas em aço inoxidável, punhos em alumínio



1778X	L mm 185	L1 mm 85	A mm 25	€ 25,00	2	017780050
-------	----------	----------	---------	---------	---	-----------

## 1781

tesoura com lâminas longas e finas



L mm	€	W	V
1781 132	15,90	2	017810001

## 1783

tesoura de serviços ligeiros



L mm	€	W	V
215	13,10	5	017830021
240	14,80	5	017830024

## 1784

tesouras série pesada



L mm	€	W	V
175	19,10	2	017840017
200	25,50	2	017840020
250	34,50	2	017840025
300	47,00	2	017840030

## 1800/100

almofada insuflável (cap. máx. elevação: 100 kg)

- elevação/nivelação
- abertura de portas em caso de emergência



A mm	B mm	S mm	€	W	V
160	150	2÷55	52,00	3	018000000

## 1808

ferro de soldar bivalente, fornecido com uma ponteira direita em aço 1824R8



W	V	€	W	V
20/130	230	65,50	1	018080001

## 1812 150

ferro de soldar instantâneo

CE



W	V	€	W	V
150	230	94,00	1	018120015

## 1814M

ferros de soldar com pontas de aço

CE



W	V	€	W	V
25	230	53,00	1	018140225
30	230	57,00	1	018140230
40	230	61,50	1	018140240

## 1820

ferros de soldar



Model	W	V	€	W	V
1820 30	30W	230V	40,00	1	018200003
1820 60	60W	230V	46,00	1	018200006
1820 80	80W	230V	64,50	1	018200008

## 1822

ferros de soldar de alta performance

CE



Model	W	V	€	W	V
1822 120	120W	230V	98,50	1	018220012
1822 180	180W	230V	104,00	1	018220018
1822 320	320W	230V	129,00	1	018220032

## 1823 60

aparelho de soldar digital fornecido com ferro de soldar

- Amplitude térmica: 160 °C ÷ 480 °C com ±1% precisão
- Modo de memorização concebido para guardar a temperatura seleccionada ao desligar o aparelho
- 3 teclas de selecção rápida (200-300-400 °C).

CE



W	V	€	W	V
60	230	377,00	1	018230060

## 1823R/60

ferro de soldar sobresselente para artigo 1823 60

CE



Model	W	V	€	W	V
1823R 60	60W	230V	75,50	1	018230066

## 1824R

ponteiras de substituição para ferros de soldar



Model	W	V	€	W	V
1824R 08	80W	230V	28,00	1	018240100
1824R 12	120W	230V	3,75	1	018240301
1824R 14-M25	140W	230V	3,75	1	018240152
1824R 14-M30	140W	230V	3,75	1	018240153
1824R 14-M40	140W	230V	3,75	1	018240154
1824R 20	200W	230V	4,95	1	018240302
1824R 60	60W	230V	4,95	1	018240303
1824R 80	80W	230V	7,35	1	018240304
1824R 120-180	120-180W	230V	59,00	1	018240305
1824R 320	320W	230V	76,50	1	018240307
1824R ST-60	60W	230V	10,40	1	018240308

## 1825B

fio de soldar em latão com antioxidante

- 1 mm<sup>2</sup>; 250 g
- Sn 99.3%; Cu 0.7%



Model	W	V	€	W	V
1825B	250g	230V	56,00	1	018250251

## 1827

máquina de soldar a gás, ajustável



1827 € 119,00 1 018270001

## 1827PC

bicos cónicos para artigo 1827



1827PC 1,6 € 24,60 1 018270501  
1827PC 3,2 € 24,60 1 018270502

## 1827PCL

ponteiras tipo faca para artigo 1827



1827PCL 2,4 € 24,60 1 018270503

## 1827PFL

peça de substituição para artigo 1827



1827PFL € 24,60 1 018270504

## 1827/K

aparelho de soldar a gás com 7 acessórios em caixa de polietileno macio



- Potência: 30 watts a 125 watts
- Temperatura dos bicos pode ser ajustada entre 250 °C e 500 °C
- Regulador de fluxo do gás
- Tempo de aquecimento: 15 segundos
- Tanque contém gás para operar 120 minutos sem paragens
- Tanque claro para visualizar o nível de gás
- Pode ser cheio com gás butano

1827/K € 185,00 1 018270100

## 1827F

maçarico recarregável de gás butano

- Depósito 35 g
- Três bicos intercambiáveis: 550 °C; 1000 °C; 1300 °C
- Fornecido com base e estojo rígido



1827F € 131,00 1 018270200

## 1830T

bomba dessoldadora com bico anti-estático em material plástico (PTFE)



L mm 190 € 13,90 5 018300021

## 1834L/USB

lanterna LED recarregável de elevada luminosidade, em aço anodizado robusto, até 450 lumens recarregável por USB

indicador de bateria fraca (alerta quando a carga da bateria é inferior a 20%)  
duração da bateria: 4h



L mm 220 € 95,50 1 018340075

## 1834RB-L/USB

bateria sobresselente para artigos 1834L/USB

1834RB-L/USB € 25,50 1 018340975

## 1834PS

tocha LED de elevada luminosidade, em alumínio anodizado robusto, até 300 lumens

- Pilhas (não incluídas): 2xAAA (duração 9/29 h)
- Lumens: 300>100>OFF
- IPX6



L mm 150 € 33,50 1 018340310

## 1834PM

tocha LED de elevada luminosidade, em alumínio anodizado robusto, até 350 lumens

- Pilhas (não incluídas) :
- 1xAAA (duração 11/33 h)
- 2xAAA (duração 13/39 h)
- 3xAAA (duração 15/45 h)
- Lumens: 350>40>OFF
- indicador de carga
- IPX6



L mm 140 € 40,50 1 018340320

## 1834PL

tocha LED de elevada luminosidade, em alumínio anodizado robusto, até 500 lumens

- Pilhas (não incluídas) :
- 1xAA (duração 20/60 h)
- 2xAA (duração 28/84 h)
- 3xAA (duração 36/108 h)
- Lumens: 500>40>OFF
- Indicador de carga
- IPX6



L mm 210 € 66,00 1 018340325

## 1834PXL

tocha LED de elevada luminosidade, em alumínio anodizado robusto, até 1350 lumens

- Pilhas (não incluídas) : 3xD (duração 36/108 hr)
- Lumens: 1350>450>OFF
- Indicador de carga
- IPX6



L mm 315 € 83,50 1 018340330

## 1834RR

Lanterna LED, recarregável na entrada do isqueiro

Foco ajustável  
Recarregável na entrada do isqueiro, 10-28V DC  
IP30  
130 lumens



1834RR € 45,00 1 018340520

## 1835/1

lanterna LED, em alumínio anodizado robusto

1 pilha AAA (não incluída)



L mm 105 € 17,50 3 018350030

## 1835/2

lanterna LED, em alumínio anodizado robusto

2 pilhas AAA (não incluídas)



L mm 145 € 18,60 3 018350060

## 1836A

lanterna de cabeça LED, dupla luminosidade, com sensor ON/OFF

- 120/65 lumens
- IP54
- Baterias: 3xAAA incluídas

CE



1836A € 46,00 1 018360050

## 1836B

lanterna de cabeça LED articulada e recarregável, dupla luminosidade, com sensor ON/OFF

- Sensor ON/OFF sem contacto
- 160 lumens
- Duração: 3-6 h
- IP65

CE



1836B € 112,00 1 018360200

## 1837N

lâmpada magnética articulada com LEDs de elevada luminosidade, até 400 lumens

- Pilhas (não incluídas) :
  - 1xAA (duração 20/60 h)
  - 2xAA (duração 28/84 h)
  - 3xAA (duração 36/108 h)
- Lumens: 400>40>OFF
- Indicador de carga
- Foco ajustável
- IPX6



1837N L mm 450 € 73,50 1 018370002

## 1837/USB

lanterna recarregável magnética, articulada, com LED's de elevada luminosidade  
carregador micro USB não incluído

- Elevada luminosidade: 150/450 lumens
- Foco ajustável
- Bateria de lítio
- Indicador do estado de carga (verde >85%; vermelho <15%)
- Duração da bateria 4-8 hours (em função da luminosidade)
- Carregamento por micro USB

IPX6



1837/USB € 107,00 1 018370051

## 1837RB/USB

bateria para lanterna ref. 1837/USB

1837/USB RB € 25,50 1 018370901

## 1837PLUS

holofote LED para estaleiros de construção

- Luminosidade: 3000 lumens; ajustável (10%; 25%; 50%; 75%; 100%)
- Fonte de energia: 100-240V AC - 50/60Hz; 26W
- protecção de impacto: IK07
- cabo: 5 m / 3x1 mm<sup>2</sup>
- Dimensões: 235 x 83 x 233 mm

CE

IP67



1837PLUS € 245,00 1 018370026



# Beta

## 1838/11LED

lanterna de inspeção recarregável com LEDs de elevada luminosidade, bateria polímero de lítio

- Construção compacta em borracha antiderrapante
- Vidro frontal de fácil substituição
- Gancho para suspensão
- Com carregador, 110-230Vac
- 320 lumens
- Com cabeça LED multi-posições



1838/11LED € 142,00 1 018380111

## 1838RA/10-11LED

fonte de alimentação para substituição para artigo 1838/10LED e 1838/11LED

1838RA/10-11LED € 31,00 1 018380903

## 1838RB/10LED

bateria para artigos 1838/10LED e 1838/11LED

1838RB/10LED € 48,00 1 018380902

## 1838RR/11LED

carregadores para artigo 1838/11LED

1838RR/11LED € 32,00 1 018380914

## 1838RV/11LED

vidro sobresselente anti-riscos para lanterna 1838/11LED



1838RV/11LED € 4,30 2 018380905

## 1838COB

lanterna LED recarregável compacta

- com gancho para pendurar e corpo em borracha antiderrapante
- bateria de lítio
- 100/200 lumens; foco 75 lumens



1838COB € 80,50 1 018380010

## 1838P

lanterna de inspeção recarregável, com dupla emissão: lâmpada e tocha

- Corpo compacto em borracha anti-derrapante
- 50/80 lumens
- Gancho de bolso
- Base magnética com rotação a 180°
- Fornecida com cabo de carregamento USB/jack, 3,5 mm
- Duração: 2,5 horas
- IP20



1838P € 69,00 1 018380005

## 1838FLASH

holofote recarregável ultracompacto, concebido para proporcionar a melhor solução possível para cada aplicação

**LUMINOSIDADE ELEVADA:** com uma capacidade máxima de iluminação de 720 lumens, com funcionamento a bateria ou cabo, está sempre pronto a utilizar.

**UTILIZAÇÃO EM QUALQUER SUPERFÍCIE:**

- em superfícies planas: com pés de borracha em 3 posições ou tripé standard 1/4" (similar ao das câmaras fotográficas)

- em estruturas metálicas: com íman ou gancho com rotação a 360 graus.

**COMPACTO:** com as dimensões 85x100x155 mm, pode ser facilmente transportado no saco de ferramentas e utilizado em espaços reduzidos.

**ROBUSTO:** concebido para resistir a esforços mecânicos extremos. Durabilidade garantida.



1838FLASH € 289,00 1 018380300

## 1838RB/FLASH

bateria para lanterna ref. 1838/FLASH

1838RB/FLASH € 63,50 1 018380930

## 1838LED/120

gambiarra LED com gancho rotativo

- cabo 5m à prova de óleo
- lâmpada LED 600-lumen, 7,5W
- abertura do gancho: 120 ÷ 170 cm



1838LED/120 € 218,00 1 018380250

## 1838LED/120-AL

fonte de alimentação com cabo de substituição para artigo 1838LED/120

1838LED/120-AL € 59,00 1 018380251

## 1838SL

lâmpada de trabalho ultra-fina com LEDs de alta luminosidade

Para trabalhos em áreas de difícil acesso

- alimentação: 12V, com adaptadores para ligação ao isqueiro e terminais para bateria
- cabo 2,5 m comprimento
- espessura: 6mm
- 345 lumens



1838SL € 62,00 1 018380101

## 1838SLR

Lanterna slim articulada, recarregável

- LED fontal compacto (200 lumens) e LED de cabeça (100 lumens) para inspeções
- Estrutura de iluminação com não mais de 9 mm de espessura
- Autonomia: 5/2,5 horas (dependendo do ajuste do nível da luz)
- Carregador USB
- Com gancho em metal e íman



1838SLR € 92,50 1 018380201

## 1838SN

Lanterna LED de inspeção, articulada, recarregável

- articulada
- compacta com borracha anti-derrapante
- gancho duplo
- imans na base e atrás para melhor ajuste
- com carregador 100-240V / 50-60Hz
- emissão dupla de luz, frente e cabeça (ponto)
- 250 lumens /ponto 150 lumens
- duração da bateria: 3h / ponto 3h
- com indicador de carga de bateria



1838SN € 95,50 1 018380132

## 1838UV

lanterna de inspeção recarregável UV com elevada luminosidade ideal para detectar fendas

- Corpo compacto em borracha antiderrapante
- Com carregador 100-240Vac / 50-60Hz
- 150 lumens / UV



1838UV € 136,00 1 018380150

## 1839/R1

transformador de saída USB, para substituição dos artigos 1834L/USB; 1836B; 1837/USB; 1838COB

1839/R1 € 19,70 1 018390501

## 1839/R2

cabo USB/ 3.5 mm de substituição para artigos 1836B; 1838P; 1838COB

1839/R2 € 7,65 1 018390502

## 1839/R3

cabo USB/MicroUSB de substituição para artigos 1834L; 1837/USB

1839/R3 € 6,00 1 018390503

## 1840BM

gambiarra 230V, casquilho: E27

- Lâmpada não incluída



IP20

1840BM V W L mm € 1 018400101  
230 60 420 60,00

## 1842LED/BM

Lanterna com LEDs de elevada luminosidade, 230 Vac

- cabo 10m comp.
- corpo compacto em borracha antiderrapante
- vidro frontal de substituição fácil
- gancho rotativo
- 340 lumens
- com cabeça LED direccionável



1842LED/BM € 118,00 1 018420301

## 1842LED/ABM

Lanterna com LEDs de elevada luminosidade, 24 V

- cabo 10m comp.
- corpo compacto em borracha antiderrapante
- vidro frontal de substituição fácil
- gancho rotativo
- 340 lumens
- com cabeça LED direccionável



1842LED/ABM € 111,00 1 018420311

## 1843BM

enrolador automático de cabo com gambiarra 230 Vac, casquilho tipo E27 e protecção metálica

- Lâmpada não incluída



1843BM € 309,00 1 018430101

## 1843R/BM

gambiarra de substituição para enroladores, casquilho E27

- Lâmpada não incluída



1843R/BM € 46,50 1 018430131

## 1846LED/BM

Lanterna LED com enrolador automático, 230 Vac

- Com transformador de segurança 230/24V
- Máx. 25 W



1846LED/BM € 355,00 1 018460301

Beta

## 1846LED/ABM

Lanterna LED  
com enrolador automático,  
24 V

• Máx. 60 W

CE



IP42  
IP65

IP42  
IP55

L=15 m

1846LED/ABM 343,00 1 018460331

## 1846R-LED/BM

lâmpadas LED  
12-24V - AC-DC



1846LED/BM R 81,00 1 018460331

## 1848

enrolador automático  
com ficha tipo Schuko

• Cabo em borracha anti-esmagamento H07 - 3x1,5 mm<sup>2</sup> - 15m  
• Max. 1600 W com cabo desenrolado  
• Max. 1200 W com cabo enrolado

CE



IP42

L=15 m

1848 320,00 1 018480015

## 1850B

pistola térmica

- Pos. 1 240 l/min. 300° C  
- Pos. 2 450 l/min. 500° C  
• pode ser usada na posição vertical  
sobre um plano de trabalho

CE



1600W  
300+500 C°

230V  
Schuko L=2,4 m

1850B L mm 240 H mm 190 126,00 1 018500011

## 1850C

pistola térmica com regulação  
electrónica

- Pos. 1 150-250 l/min. 50° C  
- Pos. 2 150-500 l/min. 50-650° C  
• visor digital  
• botões para ajuste da temperatura  
e capacidade de fluxo  
• pode ser usada na posição vertical  
sobre um plano de trabalho  
• 4 programas pré-programados e possibilidade  
de personalizar outros programas  
-Prog 1 250°C ca. 350 l/min  
-Prog 2 350°C ca. 400 l/min  
-Prog 3 450°C ca. 500 l/min  
-Prog 4 550°C ca. 400 l/min

CE



2000W  
50+650 C°

L=2,4 m

230V  
Schuko



1850C L mm 255 H mm 210 322,00 1 018500015

## 1850U...

bicos para ref<sup>a</sup>. 1850B e 1850C

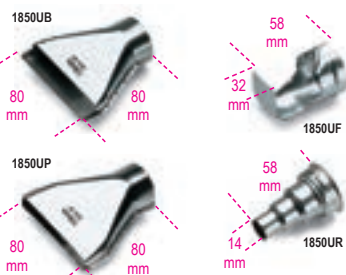

1850	€	1	018500100
1850UB B-C	21,80	1	018500100
1850UF B-C	24,00	1	018500101
1850UP B-C	21,80	1	018500102
1850UR C	20,80	1	018500103

## 1851VK

pistola de colagem a quente com 12 tubos de  
cola em caixa

CE



1851VK 46,00 1 018510058

320x250x50 mm

## 1851VK-12C

12 bastões de cola  
Ø 11 mm



1851VK-12C 11,50 1 018510062

## 1851VK-12V

12 bastões de cola  
para superfícies pintadas  
Ø 11 mm



1851VK-12V 11,50 1 018510072

## 1852R1750

ferro de indução portátil

CE



- aquecimento e desaperto de parafusos, eixos e rolamentos sem  
recurso a chama  
- permite o aquecimento de qualquer tipo de metal  
ferromagnético

Equipamento standard:

- duas ponteiros frontais, Ø 19 e 26 mm, para desaperto de  
porcas  
- uma ponteira plana para aquecimento de superfícies  
- uma ponteira flexível, 800 mm  
- estojo em plástico

Características técnicas:

- voltagem entrada: 230V AC, 50/60 Hz  
- amperagem entrada: máx. 7.5 A  
- potência: máx. 1.75 kW

EQUIPAMENTO OPCIONAL

Ponteiras disponíveis noutras dimensões

VANTAGENS

Poupança de tempo: aquecimento rápido, extremamente preciso  
Segurança: sem produção de chamas, segurança máxima do  
operador  
Funcional: possibilidade de utilização com uma mão, fácil troca  
de bobinas

ÁREAS DE APLICAÇÃO

Indústria automóvel  
Manutenção industrial  
Indústria aeronáutica  
Indústria naval  
Indústria petroquímica

1852R1750 1.305,00 1 018520175

480x370x130 mm - 4,5 kg

## 1852S-L

ponteiras laterais



	Ø mm	€	U	CE
1852S-L 19	19	39,50	1	018520501
1852S-L 20	20	39,50	1	018520502
1852S-L 23	23	39,50	1	018520503
1852S-L 26	26	39,50	1	018520504
1852S-L 32	32	39,50	1	018520505
1852S-L 38	38	45,50	1	018520506
1852S-L 45	45	50,00	1	018520507

## 1852S-F

ponteiras frontais



	Ø mm	€	U	CE
1852S-F 19	19	39,50	1	018520508
1852S-F 20	20	39,50	1	018520509
1852S-F 23	23	39,50	1	018520510
1852S-F 26	26	39,50	1	018520511
1852S-F 32	32	39,50	1	018520512
1852S-F 38	38	45,50	1	018520513
1852S-F 45	45	50,00	1	018520514

## 1852S-FLESS

ponteira flexível



	€	U	CE
1852S-FL 800	74,50	1	018520515
1852S-FL1000	94,00	1	018520517
1852S-FL1500	113,00	1	018520518

## 1852 S-PIATTE

ponteira plana

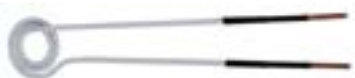

	€	U	CE
1852S-PIATTE	45,50	1	018520516

## 1860 140A

inverters de soldadura DC por eléctrodo manual MMA e TIG.  
compactos e de fácil deslocação

Arc force, hotstart, anti-sticking e proteção termoestática

Corrente regulação: 5+140A

Potência entrada: 1x230V

Factor utilização (40 °C):

25% - 140 A

60% - 100 A

100% - 90 A

Fusível retardado: 16 A

Proteção: IP23S

Eléctrodos: Ø 1.5- 4mm rútilo, básico, aço inoxidável, ferro fundido etc.

fornecido com cabos 16 mm<sup>2</sup>



	€	U	CE
1860 140A	660,00	1	018600004

## 1860 160A

inverters de soldadura DC por eléctrodo manual MMA e TIG.  
compactos e de fácil deslocação

Arc force, hotstart, anti-sticking e proteção termoestática

Corrente regulação: 5+160A

Potência entrada: 1x230V

Factor utilização (40 °C):

30% - 160 A

60% - 1030 A

100% - 110 A

Fusível retardado: 25 A

Proteção: IP23S

Eléctrodos: Ø 1.5 - 4 mm rútilo, básico, aço inoxidável, ferro fundido etc.

fornecido com cabos 25 mm<sup>2</sup>



	€	U	CE
1860 160A	791,00	1	018600006

# Beta

## 1860RC

cabos de soldadura para inverters de soldadura artigo 1860

comprimento do cabo de suporte do eléctrodo: 2.5m  
comprimento do fio de terra: 1.8m



	€	U	CE
1860RC/140A	72,50	1	018600604
1860RC/160A	92,00	1	018600606

## 7042LCD

Máscara com LCD de escurecimento automático, para soldadura por eléctrodo; MIG/MAG; TIG e plasma.

Alimentação através de células solares e baterias de lítio para maior durabilidade do filtro LCD

- Área do visor: 98x43 mm
- Escurecimento: DIN 9-13, ajustável externamente
- Protecção UV/IR
- Tempo escurecimento: 1/25000s
- Tempo aclaramento: 0.25-1s
- Sensibilidade e tempo de escurecimento ajustáveis
- On/off automático
- Adequada para rebarbar
- Forma optimizada para que o utilizador respire mais facilmente com a máscara colocada



	€	U	CE
7042LCD	166,00	1	070420001

## 7042LCD/RV

protector anti-riscos para artigo 7042LCD

	€	U	CE
7042LCD/RV	2,00	2	070420101

## 7042LCD/RV-INT

lente interna para artigo 7042LCD

	€	U	CE
7042LCD/RV-INT	1,35	2	070420102

# Beta

# Beta



## 1870

aspirador para sólidos e líquidos, 20 l

- motor bypass monofásico
- voltagem: 230/240 V
- frequência: 50/60 Hz
- potência máx.: 1200 W
- débito : 58 l/sec.
- potência máx. de aspiração: 190 mbar
- cap. máx. do tambor: 20 l, em PP antiestático
- emissão sonora: <70 dB(A)
- comp. do cabo: 5 m
- carro para acessórios
- ACESSÓRIOS STANDARD, Ø 36 mm
- 1 tubo flexível com punho ergonómico
- 2 tubos de extensão rígidos
- 1 escova multiusos para soalhos e líquidos
- 1 bocal plano
- SISTEMAS DE FILTRAGEM
- 1 filtro de cartucho de superfície 1900 cm<sup>2</sup> - 12 µm nom.
- 1 filtro anti-espuma PPI 45/PPI 30

CE



IPX4

1870 € 197,00 1 018700020

## 1871M

aspirador para sólidos e líquidos, 35 l, com tomada elétrica e pneumática

- limpeza automática do filtro
- motor bypass de dois estágios
- voltagem: 230/240 V
- potência máx.: 1200 W
- potência máx. da tomada elétrica: 2000 W
- ligação máx. da tomada pneumática: 15 bar
- débito: 60 l/sec.
- potência máx. aspiração: 220 mbar
- cap. máx. do tambor: 35 l, em PE-HD antiestático
- emissão sonora: <68 dB(A)
- comp. do cabo: 7 m
- ACESSÓRIOS STANDARD
- 1 tubo flexível com punho ergonómico
- 2 tubos de extensão em plástico
- 1 escova combinada
- 1 secção com tubos aspiração de líquidos
- 1 bocal plano
- 1 união em borracha para conexão da ferramenta; Ø interno: 26 mm
- 6 pinças, com tubo de aspiração
- SISTEMAS DE FILTRAGEM
- saco de filtro em papel; classe IFA: "M"
- filtro de cartucho; classe IFA: "M"
- filtro anti-espuma PPI 45/PPI 30

CE



1871M € 1.197,00 1 018710035

## 1872L

aspirador para sólidos e líquidos, 35 l, classe certificada "L"

- by-pass do motor de dois estágios
- voltagem: 230/240 V
- frequência: 50/60 Hz
- potência máx.: 1.100 W
- débito: 55 l/sec.
- potência máx. de aspiração: 220 mbar
- capacidade máx. do tambor: 35 l, antiestático PE-HD
- emissão sonora: <68 dB(A)
- comprimento do cabo: 6 m
- ACESSÓRIOS STANDARD, Ø 36 mm
- 1 tubo flexível com um punho ergonómico
- 2 tubos de extensão em plástico
- 1 escova combinada
- 1 secção com tubos de aspiração de líquidos
- 1 bocal plano
- SISTEMAS DE FILTRAGEM
- 1 saco de filtro em papel; filtragem classe "L"
- 1 filtro de cartucho de superfície; IFA classe: "L"
- 1 filtro anti-espuma PPI 45/PPI 30
- 2 pós-filtros em PET lâmina PP

CE



IPX4

1872L € 428,00 1 018720135

## 1873

aspirador para sólidos e líquidos, 30 l, tambor em aço inoxidável

- motor bypass de dois estágios
- voltagem: 230/240 V
- frequência 50/60 Hz
- potência máx.: 1100 W
- débito : 55 l/sec.
- pressão máx. aspiração: 220 mbar
- cap. máx. tambor: 30 l, em aço inoxidável
- emissão sonora: <61 dB(A)
- comp. cabo: 6 m
- carro para acessórios
- ACESSÓRIOS STANDAR, Ø 45 mm
- 1 tubo flexível com punho ergonómico
- 2 tubos de extensão em aço inoxidável
- 1 escova industrial
- 1 adaptador industrial para alcatifas
- 1 secção industrial tubos para aspiração de líquidos
- 1 bocal plano
- 1 bocal triangular
- SISTEMAS DE FILTRAGEM
- 1 saco de filtro em papel
- 1 filtro de cartucho de superfície 1900 cm<sup>2</sup>, 12 µm nom.
- 1 filtro anti-espuma PPI 45/PPI 30

CE



1873 30 € 573,00 1 018730030

## 1874

aspirador para sólidos e líquidos, 50 l, tambor em aço inoxidável

- motor bypass de dois estágios
  - voltagem: 230/240 V
  - frequência: 50/60 Hz
  - potência máx.: 1350 W
  - débito : 55 l/sec.
  - pressão máx. aspiração: 240 mbar
  - cap. máx. do tambor: 50 l, em aço inoxidável
  - emissão sonora: <63 dB(A)
  - comp. cabo: 6 m
  - carro para acessórios
- ACESSÓRIOS STANDARD: Ø 45 mm
- 1 tubo flexível com punho ergonómico
  - 2 tubos de extensão em aço inoxidável
  - 1 escova industrial
  - 1 adaptador industrial para alcatifas
  - 1 secção industrial com tubos de aspiração de líquidos
  - 1 bocal plano

### SISTEMAS DE FILTRAGEM

- 1 saco de filtro em papel
- 1 filtro de cartucho de superfície 5200 cm<sup>2</sup>, 12 µm nom.
- 1 filtro anti-espuma PPI 45/PPI 30

CE



1874 50 € 725,00 1 018740050

## 1870-20/5S

5 sacos de papel horizontais para artigo 1870



1870 20/5S € 46,50 1 018700021

## 1870-72 /FC

filtro de cartucho 1900 cm<sup>2</sup> 12 - µm nom. Para artigos 1870 - 1872 - 1873



1870-72 /FC € 40,00 1 018700026

## 1870-72/FL

filtro para aspiração de líquidos para artigos 1870 - 1872 - 1873 - 1874



1870 72/FL € 14,20 1 018700027

## 1872L 35/FC

filtro de cartucho, classe "L", para artigo 1872L 35



1872L 35/FC € 49,50 1 018720144

## 1872L 35/5S

5 sacos de pano descartáveis, classe "L"



1872L 35/5S € 74,50 1 018720136

## 1873-30/5S

5 sacos de papel verticais para artigo 1873



1873 30/5S € 47,00 1 018730031

## 1874-50/5S

5 sacos de papel verticais para artigo 1874



1874 50/5S € 58,50 1 018740051

## 1874-50/FC

filtro de cartucho 5200 cm<sup>2</sup> - 12 µm nom. para artigo 1874



1874 50/FC € 49,00 1 018740056

## 1877

aparador de óleo com rodas e depósito de 90 l

- indicador do nível
- depósito de grande diâmetro com grelha de retenção; capacidade 90 l
- purga do depósito pneumático através de tubo com 1.8 m
- tabuleiro para ferramentas

CE



1877 € 629,00 1 018770008

## 1877A

aparador de óleo / aspirador com rodas, depósito de 90 l e antecâmara

- indicador do nível
- depósito de grande diâmetro com grelha de retenção; capacidade 12 l
- antecâmara transparente: capacidade 9.5 l
- tubo de aspiração 1.8 m
- purga do depósito pneumático através de tubo com 1.8 m
- tabuleiro para ferramentas

### Acessórios standard:

- 1 sonda rígida, Ø 5x700 mm
- 1 sonda flexível, Ø 5x700 mm
- 1 sonda rígida, Ø 6x600 mm
- 1 sonda flexível, Ø 6x700 mm
- 1 sonda flexível, Ø 7x700 mm
- 1 sonda flexível, Ø 8x700 mm
- adaptadores para VW, BMW, CITROËN

CE



1877A € 1.090,00 1 018770080

### 1878 3

reservatório colector de óleo,  
para os cubos das rodas de pesados  
Com aparador de gotas



1878 3    lt    €    18,60    1    018780003

### 1878 11

reservatório colector de fluido

- Capacidade máxima: 11 l
- Válvula drenagem de fluidos
- Revestimento interior para prevenir fugas de fluido durante o transporte



1878 11    lt    €    32,50    1    018780011

### 1878 30

reservatório colector de fluido

- Capacidade máxima: 30 l
- Grelha anti-salpicos
- Equipado com 4 rodas giratórias

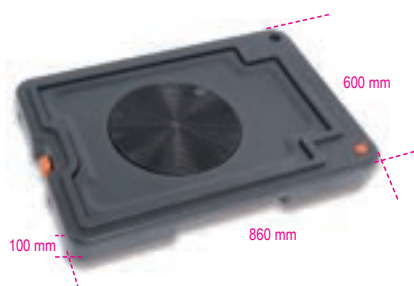

1878 30    lt    €    123,00    1    018780030

### 1879

extractor manual/pneumático de fluido 9.5 l



1879    €    268,00    1    018790001

### 1879R/K4

jogo de 4 tubos de substituição para extractor  
de líquidos 1879



1879R/K4    €    50,50    1    018790504

### 1880

bomba manual para bidons



1880    gr    €    50,50    1    018800001

### 1881

bomba pneumática, ratio 3:1



1881    l/min    €    435,00    1    018810001

### 1882

Pistola de óleo com extremidade flexível e  
apanha-gotas automático

- 1/2"
- Débito máx.: 65 l/min
- Pressão de trabalho máx.: 100 bar
- Bloqueio do gatilho



1882    €    130,00    1    018820010

### 1883

Contador digital para óleo

- 1/2"
- Revestimento anti-impacto em borracha
- Pilha: 1 CR2 (incluída)
- Débito máx.: 0+35 l/min (0+9 gal/min)
- Pressão máx.: 50 bar (750 psi)
- Viscosidade: 8-5000 mPas
- Tolerância: ±5%

CE



1883    €    196,00    1    018830035

### 1883NC

Bocal macho-macho, 1/2,  
para refs. 1882 e 1883



1883NC    €    12,00    1    018830135

### 1884

chave para filtros de óleo  
de caixas de velocidades e diferenciais  
manuais e automáticos

Com 12 adaptadores para ligação directa



1884    €    426,00    1    018840010

- AT-101    FORD
- AT-102    UNIVERSAL (Bmw, Honda, Nissan...)
- AT-103    VW-AUDI
- AT-104    VW-AUDI-PORSCHE
- AT-105    VW-AUDI-MINI COOPER
- AT-106    MERCEDES
- AT-107    DSG
- AT-108    VW-AUDI CVT
- AT-109    VOLVO
- AT-110    TOYOTA-LEXUS
- AT-111    SKODA
- AT-112    VW Passat/Tiguan <2007

## 1884/C12

jogo de adaptadores para artigo 1884



1884/C12 € 156,00 1 018840100

## 1889

base em aço para transporte e armazenagem de bidões 2 200-l

- Pintura epoxy
- Fácil de transportar com empilhador ou porta-paletes
- O apoio não deve ser colocado sob qualquer peça

CE

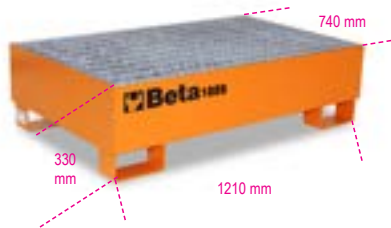

1889 € 707,00 1 018890200

## 1889CF

chave universal para bidons

- 1 sextavado fêmea Ø 38 mm
- 1 perfil de 4 setores Ø 42 mm
- 1 lâmina 17x7 mm



L mm 270 € 29,50 1 018890010



## 1895 6

Tanque de limpeza ultrassônico, 6 l

Com função especial de Degas (eliminação de bolhas)



CE

- A limpeza ultrassônica processa-se através do aquecimento do fluido para uma boa limpeza das peças de substituição, componentes metálicos em geral (injetores, carburadores, válvulas etc.)
- Ecrã digital para seleção da temperatura e tempo de limpeza.
- Dois modos de limpeza: "suave" e "normal".
- Para limpeza normal, utilize apenas água a uma temperatura de 50-60 °C
- Para uma limpeza mais precisa, adicione detergentes não-espumosos específicos para tanques ultrassônicos
- Ao utilizar o modo de Degas acelera a libertação de ar no tanque, melhorando, assim, a eficiência da limpeza ultrassônica.

### CARACTERÍSTICAS TÉCNICAS

Capacidade do tanque: 6 l  
Torneira de purga  
Potência: 150 W  
Potência de aquecimento: 300 W  
Amplitude térmica: 0+80 °C  
Intervalo de tempo de limpeza: 0-99  
Frequência: 40 kHz  
Voltagem: 220/230V  
Dimensões: 330x180x310 mm

1895 6 € 631,00 1 018950060

## 1895 13

tanque de limpeza ultrassônico, 13 l

com função especial de degaseificação



CE

- A limpeza ultrassônica baseia-se no aquecimento do fluido para limpar eficazmente peças de substituição e componentes metálicos em geral (carburadores, válvulas etc.)
- Monitor digital para seleção da temperatura e tempo de limpeza
- Dois modos de limpeza: "suave" e "normal"
- Para limpeza normal, utilize apenas água a uma temperatura de 50/60 °C
- Para uma limpeza mais profunda, adicione uma solução de detergente sem formação de espuma (tipo Arexons Fulcron Extra) específica para tanques ultrassônicos
- A utilização do modo degaseificação acelera a movimentação de ar através do tanque, melhorando a eficiência da limpeza ultrassônica

### CARACTERÍSTICAS TÉCNICAS

Capacidade do tanque: 13 l  
Torneira de purga  
Potência: 300 W  
Potência de aquecimento: 400 W  
Intervalo temperatura: 0+80 °C  
Tempo de limpeza: 0-99 minutos  
Frequência: 40 kHz  
Potência entrada: 220/230V  
Dimensões: 350x325x320 mm

1895 13 € 971,00 1 018950130

## 1895 27

tanque de limpeza ultrassônico, 27 l

com função especial de degaseificação



CE

- A limpeza ultrassônica baseia-se no aquecimento do fluido para limpar eficazmente peças de substituição e componentes metálicos em geral (carburadores, válvulas etc.)
- Monitor digital para seleção da temperatura e tempo de limpeza
- Dois modos de limpeza: "suave" e "normal"
- Para limpeza normal, utilize apenas água a uma temperatura de 50/60 °C
- Para uma limpeza mais profunda, adicione uma solução de detergente sem formação de espuma (tipo Arexons Fulcron Extra) específica para tanques ultrassônicos
- A utilização do modo degaseificação acelera a movimentação de ar através do tanque, melhorando a eficiência da limpeza ultrassônica

### CARACTERÍSTICAS TÉCNICAS

Capacidade do tanque: 27 l  
Torneira de purga  
Potência: 500 W  
Potência de aquecimento: 500 W  
Intervalo temperatura: 0+80 °C  
Tempo de limpeza: 0-99 minutos  
Frequência: 40 kHz  
Potência entrada: 220/230V  
Dimensões: 530x330x380 mm

1895 27 € 1.345,00 1 018950270

## 2250-O

Banco giratório com tabuleiros, vazio



2250-O € 91,50 1 022500011

## 2251-O

Banco giratório com gavetas, vazio

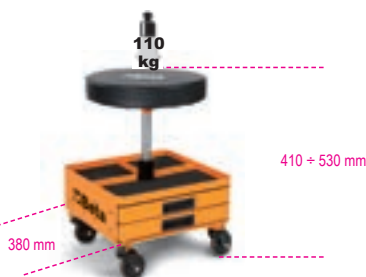

2251-O € 162,00 1 022510011

## 2252

banco rolando

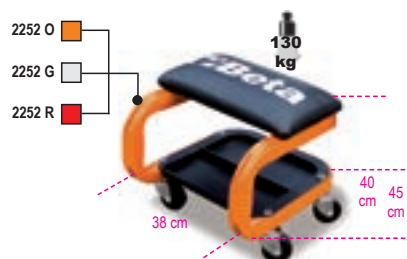

2252-O	€ 159,00	1	022520001
2252-G	€ 159,00	1	022520002
2252-R	€ 159,00	1	022520003

## 2252KR4

rodízios de substituição para banco 2252



2252KR4	€ 53,50	1	022520900
---------	---------	---	-----------

## 2258-O

Banco com compartimento para ferramentas, vazio



2258-O	€ 164,00	1	022580011
--------	----------	---	-----------

## 2254C

Proteção com ventosas para carroçarias

Em tecido com revestimento de borracha, com 4 ventosas na parte superior



2254C	€ 43,50	1	022540200
-------	---------	---	-----------



## 2254F

Proteção frontal para veículo

Proteção frontal do veículo, com aberturas para faróis e radiador.



- Impermeável
- Resistente ao óleo e massa
- Fixação de correias
- Material: 98% poliamida / nylon, 2% poliuretano

2254F	€ 75,00	1	022540150
-------	---------	---	-----------

## 2254SV

Protetor reutilizável de banco e volante

Adaptável à maioria dos assentos de carro e volantes



- =C182
- Reutilizável e lavável
- Em nylon resistente com sequências de estiramento
- G46Material: 98% I46poliamida, 2% poliuretano

2254SV	€ 22,90	1	022540100
--------	---------	---	-----------

## 2254T

Esteira pequena

Em espuma EVA antiderrapante



2254T	€ 25,00	1	022540047
-------	---------	---	-----------

## 3000M/LT

estrado

- Cobertura em PVC forrado com borracha acolchoada para um maior conforto.

POSIÇÃO DA CABEÇA AJUSTÁVEL EM TRÊS POSIÇÕES



3000M/LT	€ 151,00	1	030000220
----------	----------	---	-----------

7,3 kg

## 3000M/RLS

rodízios de substituição para estrado



3000M/RLS	€ 10,90	1	030000206
-----------	---------	---	-----------

## 3002

esteira e banco

- Estrutura em aço
- Cobertura em PVC acolchoado
- Facilmente convertível em esteira ou banco

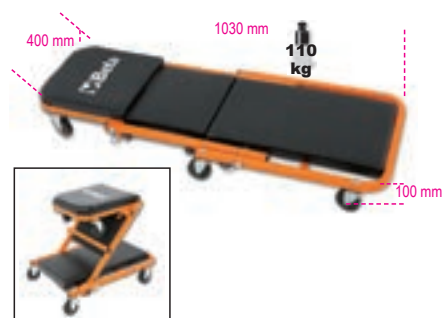

3002	€ 100,50	1	030020001
------	----------	---	-----------

## 3002/RLS

jogo de 6 rodas de substituição para esteira/banco 3002



3002/RLS	€ 25,50	1	030020501
----------	---------	---	-----------

### 3003

esteira  
em plástico anti-choque  
• Ø das rodas: 76 mm



3003 € 78,00 1 030030001

### 3003/RLS

jogo de 6 rodas de substituição para esteira/  
banco 3003



3003/RLS € 41,00 1 030030501

### 3007

trolley inferior para veículos  
sem rodas dianteiras / eixo traseiro

Permite o fácil manuseamento de veículos sem  
rodas dianteiras ou eixo traseiro durante o trabalho  
• 4 rodas giratórias, incluindo 2 com travão, adequadas para  
utilização em cabinas de pintura  
• 2 apoios móveis para adaptação a todos os chassis  
• capacidade máx.: 800 kg

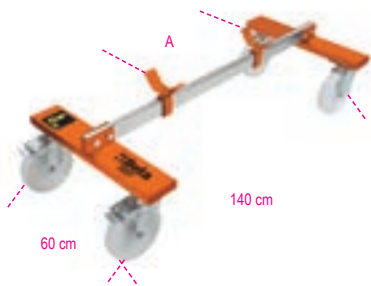

3007 € 489,00 1 030070001

### 3008

macaco e dispositivo de posicionamento  
para rodas simples e duplas em veículos  
pesados

• capacidade máx.: 700 kg  
• altura mínima: 140 mm  
• altura máx.: 660 mm  
• distância entre rolos: 470÷740 mm  
• dispositivo de segurança hidráulico contra sobrecargas  
• rodas frontais giratórias



3008 € 2.710,00 1 030080100

### 3009

Elevador para rodas

Capacidade máxima de elevação: 550 kg  
4 rodas de apoio  
Largura das rodas: 200 mm  
Para rodas até 240 mm de largura

Ideal para:  
• carregar automóveis danificados para camiões de reboque  
• oficinas de reparação de automóveis  
• movimentação de veículos em salas de exposições

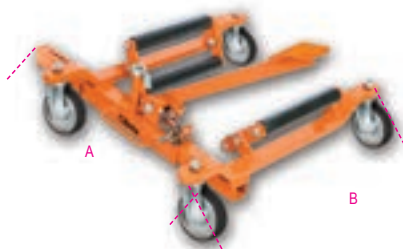

A B € 378,00 1 030090001

### 3009R/GR4

conjunto de 4 rodízios para elevador de rodas



3009R/GR4 € 151,00 1 030090501

### 3010/T...

preguiças, par

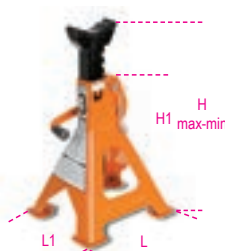

C max	H min	H max	H1	L	L1
kg	mm	mm	mm	mm	mm
2000	280	425	245	185	165

3010T 2 € 89,50 1 030100002

C max	H min	H max	H1	L	L1
kg	mm	mm	mm	mm	mm
3000	285	430	250	180	195

3010T 3 € 106,00 1 030100003

C max	H min	H max	H1	L	L1
kg	mm	mm	mm	mm	mm
6000	400	580	340	245	280

3010T 6 € 153,00 1 030100006

C max	H min	H max	H1	L	L1
kg	mm	mm	mm	mm	mm
10000	471	735	420	330	290

3010T 10 € 262,00 1 030100010

### 3011/T

macacos de garrafa hidráulicos



C max	H min	H Max	L
kg	mm	mm	mm
3500	170	366	86

3011T 3,5 € 89,50 1 030110035

C max	H min	H Max	L
kg	mm	mm	mm
5000	203	467	118

3011T 5 € 100,50 1 030110050

C max	H min	H Max	L
kg	mm	mm	mm
10000	220	484	114

3011T 10 € 150,00 1 030110100

C max	H min	H Max	L
kg	mm	mm	mm
15000	230	497	113

3011T 15 € 186,00 1 030110150

C max	H min	H Max	L
kg	mm	mm	mm
20.000	245	521	115

3011T 20 € 264,00 1 030110200

### 3012

apoios para motor



L	C max	€
mm	kg	
1500	500	271,00
1800	400	366,00

### 3012C

suporte para motores

ideal para veículos ligeiros e comerciais



3012C € 714,00 1 030120255

### 3012I

suporte inferior para motores

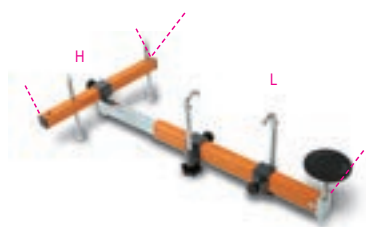

3012I	L mm	H mm	€	1	030120250
	630+960	190	633,00		

### 3014

suporte para motores



3014	€	1	030140010
	344,00		

### 3014R/GR5

jogo de 5 rodas de substituição para suporte motores 3014



3014R/GR5	€	1	030140501
	85,50		

### 3014 SAR

Suporte para motores

Capacidade máxima: 450 kg



3014SAR	€	1	030140360
	1.240,00		

### 3014SAR/RR

jogo de 4 rodas de substituição para suporte motores 3014SAR



3014SAR/RR	€	1	030140370
	140,00		

### 3014SAR/1

Reservatório colector de fluido

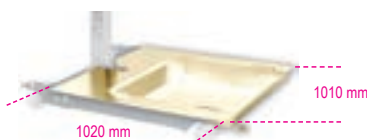

3014SAR/1	€	1	030140361
	366,00		

1020x1010x11 mm

### 3014SAR/2

Grampo para fixação de caixas de velocidades no suporte ref. 3014 SAR

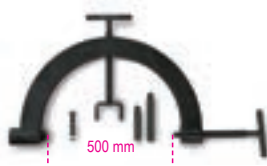

3014SAR/2	€	1	030140362
	355,00		

### 3025

Grua hidráulica rebatível com bomba de efeito duplo

Capacidade: 1 ton

CE



3025	3025	€	1	030250001
		1.715,00		

### 3025/RF

jogo de 2 rodas de substituição para grua hidráulica 3025



3025/RF	€	1	030250901
	218,00		

### 3025/RG

jogo de 2 rodízios de substituição para grua hidráulica 3025



3025/RG	€	1	030250902
	323,00		

### 3025/PF

alicate para bidões

Capacidade máxima: 300 kg

CE



3025/PF	A mm	B mm	€	1	030250011
	550+640	70	275,00		

### 3026 0,3

macaco de fossas hidráulico

CE



3026 0,3	€	1	030260003
	627,00		

### 3026/R0,3

jogo de 4 rodízios de substituição para macaco de fossas hidráulico 3026 0,3



3026/R 0,3	€	1	030260903
	157,00		

### 3026 0,5

Macaco de fossas hidráulico,  
500 kg

CE



3026 0,5 € 744,00 1 030260005

### 3026/R0,5

jogo de 4 rodízios de substituição para  
macaco de fossas hidráulico 3026 0,5



3026/R 0,5 € 232,00 1 030260905

### 3026 1,0

macaco de fossas hidráulico

Capacidade máxima: 1 t

CE



3026 1,0 € 902,00 1 030260010

### 3026/S

suporte giratório para transmissões  
com casquilho de redução para macacos de  
fossas ref. 3026

Capacidade máxima: 500 kg



3026/S € 524,00 1 030260501

### 3026/SP

suporte de transmissão universal

permite a montagem e desmontagem de quaisquer  
transmissões por apenas um operador  
em veículos ligeiros, comerciais e todo-o-terreno de forma  
rápida e segura.



3026/SP € 611,00 1 030260505

### 3027 10

prensa hidráulica com pistão

Capacidade máxima: 10 t

CE



3027 10 € 1.510,00 1 030270010

140 kg

### 3027 20

Prensa hidráulica com pistão  
20 t

Capacidade máxima: 20 t

CE



3027 20 € 2.095,00 1 030270020

140 kg

### 3027 30

prensa hidráulica com guincho e pistão móvel

Capacidade máxima: 30 t

CE



3027 30 € 3.650,00 1 030270030

230 kg

### 3027 50

prensa hidráulica com pistão e guincho

Capacidade máxima: 50 t

CE



3027 50 € 4.990,00 1 030270050

350 kg

### 3027/KP

Jogo de punções e placa  
para ref. 3027

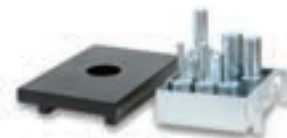

3027/KP10	3027 10	€ 333,00	1	030270510
3027/KP20	3027 20	€ 447,00	1	030270520
3027/KP30	3027 30	€ 447,00	1	030270530
3027/KP50	3027 50	€ 529,00	1	030270550



### 3027/KPP50

pedal de controlo para prensa hidráulica ref. 3027 20-30-50



3027/KPP50 € 218,00 1 030270555

### 3030/2T

macaco hidráulico, 2 t com 6 rodas

- Duas rodas frontais giratórias em plástico (PTFE)
- Macaco hidráulico facilmente manobrável em superfícies irregulares
- Capacidade máxima: 2 toneladas



3030/2T € 709,00 1 030300020  
43 kg

### 3030/2T-R5

roda dianteira de substituição para macaco hidráulico 3030 2T



3030 2T/R5 € 24,60 1 030300505

### 3030/2T-R6

roda traseira de substituição para artigo 3030/2T



3030 2T/R6 € 39,00 1 030300506

### 3030/2TRP

prato de borracha 85 mm sobresselente para ref. 3030/2T



3030/2TRP € 4,95 5 030300501

### 3033/3T

macaco hidráulico, 3t versão longa

- Para utilização em veículos comerciais
- Capacidade máxima: 3 t
- Rodas em poliamida



3033/3T € 925,00 1 030330030

### 3035

carro para movimentação de pneus

- Para transporte fácil de pneus até 980 mm de diâmetro
- A estrutura robusta permite a movimentação de pneus sem ter de suportar o peso fisicamente
- Pode ser utilizado para posicionamento da roda
- 2 rodas Ø 260 mm
- 2 rodas Ø 125 mm
- Altura máx. de carga: 1.60 m
- Peso máx. de carga: 200 kg
- Garfos ajustáveis em 2 posições:  
primeira posição: abertura máxima 880 mm  
segunda posição: abertura máxima 980 mm



3035 € 870,00 1 030350100

### 3061/2T

macaco hidráulico, 2 ton - 2 estádios



Equipado com:

- diafragma três camadas de alta resistência e guia telescópica interna
- batente fim de curso e válvula de segurança contra sobrecarga
- pode ser utilizado com elevadores de garagem

CARACTERÍSTICAS TÉCNICAS

capacidade: 2 t  
peso: 14 kg  
pressão de trabalho: 8-10 bar  
altura: min. 132 - max. 326 mm

3061/2T € 796,00 1 030610020

### 3061/2T-P50

extensão 50 mm para artigo 3061/2T



3061/2T P50 € 68,00 1 030610021

### 3061/2T-P100

extensão 100 mm para artigo 3061/2T



3061/2T P100 € 90,50 1 030610022

## 3063/2,5T

macaco hidráulico, 2.5 ton, com rodas



A	1436 mm
B	250 mm
C	2173 mm
D	88 mm
E	365 mm
F	330 mm

Particularmente adequado para veículos comerciais e comerciais ligeiros.  
Ideal para garagens e oficinas

EQUIPADO COM:

- retorno automático do braço
- comando velocidade em carga total

CARACTERÍSTICAS TÉCNICAS

capacidade: 2.5t

peso: 75 kg

pressão de trabalho: 8-10 bar

consumo de ar: 400 l/min

3063/2,5T € 2.195,00 1 030630125

## 3065/20-10T

macaco hidráulico, 20-10 t, com mala

Portátil e leve, ideal para operações de assistência no exterior



A	254 mm	F	30 mm
B	150 mm	G	16 mm
C	200 mm	H	230 mm
D	140 mm	I	14 mm
E	200 mm	J	10 mm
		K	20 mm
		L	20 mm
		M	20 mm
		N	20 mm

- Fornecido com duas extensões, 75 e 60 mm de comprimento

CARACTERÍSTICAS TÉCNICAS

capacidade: 20-10 t

peso: 23 kg

pressão: 8-10 bar

consumo de ar: 400 nl/min

3065/20-10T € 2.375,00 1 030650100

## 3065/40-20T

macaco hidráulico, 40/20 toneladas

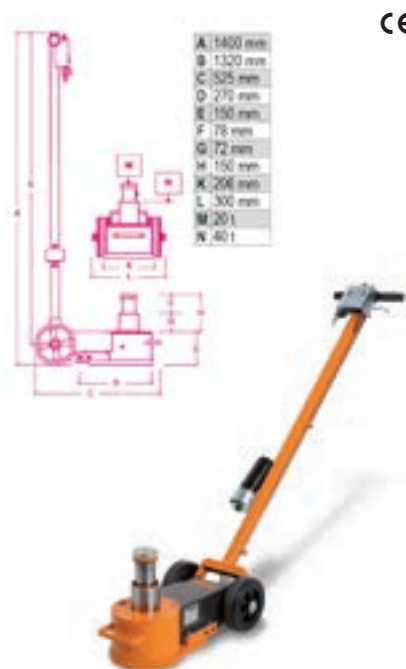

A	1400 mm
B	1320 mm
C	525 mm
D	270 mm
E	150 mm
F	78 mm
G	72 mm
H	150 mm
I	200 mm
L	300 mm
M	201 mm
N	401 mm

- adequado para veículos pesados
- funcional e de fácil manuseamento, também para transporte em oficinas móveis
- retorno automático do pistão
- duas válvulas de descida com comando da velocidade sob carga

CARACTERÍSTICAS TÉCNICAS

capacidade: 40/20 tons

peso: 39 kg

pressão de trabalho: 8-10 bar

consumo de ar: 400 l/min

3065/40 20T € 2.710,00 1 030650200



## 3067/60-15T

macaco pneumático, 60-30-15 t

Com uma altura mínima de 120 mm, é particularmente adequado para utilização em veículos pesados de passageiros

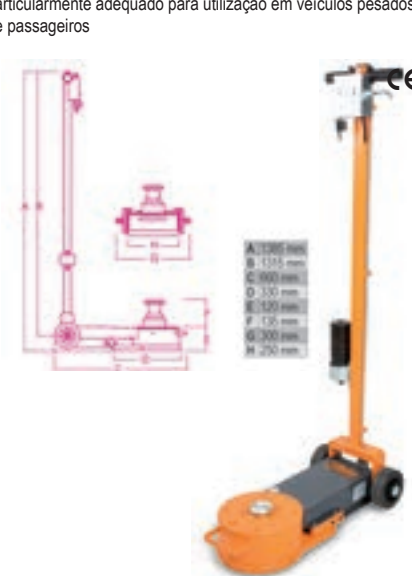

A	1000 mm
B	1100 mm
C	600 mm
D	130 mm
E	130 mm
F	120 mm
G	300 mm
H	250 mm

- Retorno automático do pistão
- Duas válvulas de descida com control oda velocidade sob carga
- Fornecido com duas extensões, 70 e 120 mm de comprimento

CARACTERÍSTICAS TÉCNICAS

capacidade: 60-30-15 t

peso: 56 kg

pressão: 8-10 bar

consumo de ar: 600 l/min

3067/60-30-15T € 3.960,00 1 030670120

## 3067/70-13T

macaco hidráulico, 70-43-23-13 t

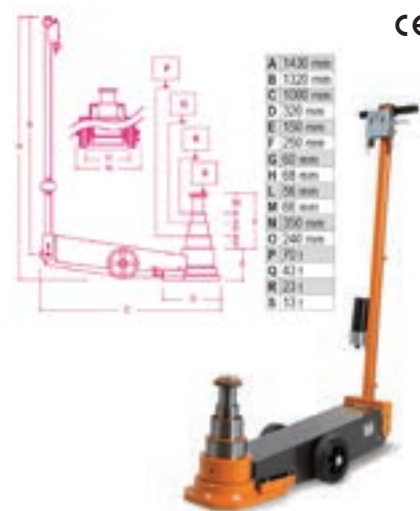

A	1400 mm
B	1320 mm
C	1000 mm
D	320 mm
E	150 mm
F	250 mm
G	50 mm
H	68 mm
I	56 mm
L	76 mm
M	68 mm
N	350 mm
O	240 mm
P	70 mm
Q	43 mm
R	23 mm
S	13 mm

- Versão longa, adequada para utilização em veículos pesados, articulados, pesados de passageiros e máquinas agrícolas
- retorno automático do pistão
- duas válvulas de descida com controlo da velocidade sob carga

CARACTERÍSTICAS TÉCNICAS

capacidade: 70-43-23-13 tons

peso: 74 kg

pressão de trabalho: 8-10 bar

consumo de ar: 600 l/min

3067/70 13T € 5.010,00 1 030670130

# FERRAMENTAS PARA MOTOCICLOS



## 3040

preguiça para motociclos regulável

- Lacado preto mate
- Suporte móvel em poliamida
- 4 rodas em borracha termoplástica



3040 € 91,50 1 030400001

## 3040A/1

calhas em V (par) para ref. 3040



3040A/1 € 38,00 1 030400501

## 3040A/2

calhas de borracha em L (par), para ref. 3040



3040A/2 € 44,50 1 030400502

## 3040A/6-8-10

linguetes (par) em alumínio para ref. 3040A/1



3040A/6 € 33,50 1 030400506

M6x1 mm  
Aprilia, Yamaha, Triumph

3040A/8 € 33,50 1 030400508

M8x1.25 mm  
Suzuki, Honda, Ducati

3040A/10 € 33,50 1 030400510

M10x1.25 mm  
Kawasaki

## 3041

apoio frontal para motociclos ajustável

- Lacado preto mate
- Suporte móvel em poliamida
- 4 rodas em borracha termoplástica



3041 € 91,50 1 030410001

## 3041A/11

calhas de rolo (par) para ref. 3041



3041A/11 € 64,00 1 030410511

## 3041A/15

calhas cónicas (par) para ref. 3041



3041A/15 € 35,50 1 030410515

## 3041T

apoio frontal para motociclos ajustável

- Lacado preto mate
- Suporte móvel em poliamida
- 4 rodas em borracha termoplástica



3041T € 97,50 1 030410011

## 3041T/17

calhas em L (par), em borracha, para artigo 3041T



3041T/17 € 38,50 1 030410517

## 3042

apoio frontal para pino de direcção de motociclos

- Inclui jogo de 6 pinos
- Lacado preto mate
- 4 rodas em borracha termoplástica



3042 € 292,00 1 030420001

## 3042/K6P

kit 6 pinos de apoio para motociclos ref. 3042

(já incluído na ref. 3042)



3042/K6P € 104,00 1 030420101

## 3043

apoio para motociclos com braço à esquerda

- Lacado preto mate
- Suporte móvel em poliamida
- 4 rodas em borracha termoplástica



3043 € 217,00 1 030430001

## 3043A/41÷48

pino para ref. 3043



	∅ mm	€		
3043A/41 Ducati	21,8	41,50	1	030430541
3043A/42 Triumph	27,5	41,50	1	030430542
3043A/43 MV - Ducati	42	62,00	1	030430543
3043A/44 Ducati 1098	40	62,00	1	030430544
3043A/45 Honda	28,6	41,50	1	030430545
3043A/46 BMW F800S	30	58,50	1	030430546
3043A/47 BMW K,R,S	52,9	100,50	1	030430547
3043A/48 Honda CB1000R	28,3	40,50	1	030430548

## 3044

apoio para motociclos com braço à direita

- Suporte móvel em aço
- Lacado preto mate
- 4 rodas em borracha termoplástica



3044 € 213,00 1 030440001

## 3044A/41

pino direito para Ducati 848



3044A/41 € 40,50 1 030440541

### 3047

Cavelete manual para motocicletas cross/ enduro



3047 € 156,00 1 030470001

### 3048

Preguiça em alumínio

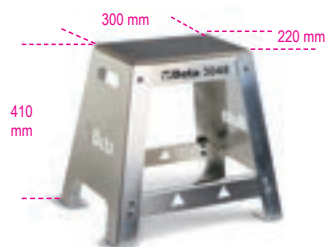

3048 € 337,00 1 030480001

### 3050/C

Elevador manual para motocicletas Custom, Enduro, Cross, Scooter

Inclui suporte ajustável e kit de amortecedores em borracha

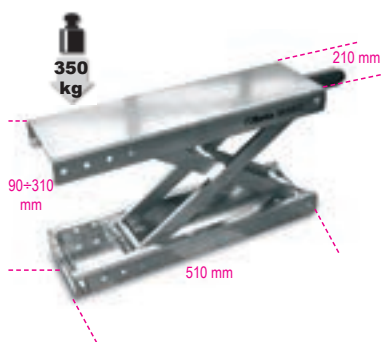

3050/C € 511,00 1 030500011

### 3050/CL

Elevador auxiliar

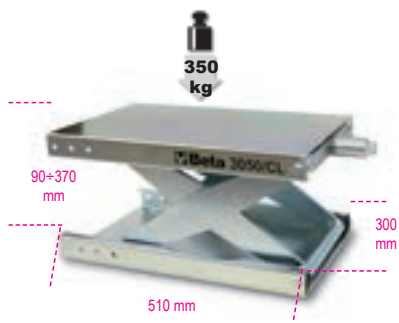

3050/CL € 535,00 1 030500021

### 3050/K

Elevador para motocicletas electro-hidráulico 600 kg

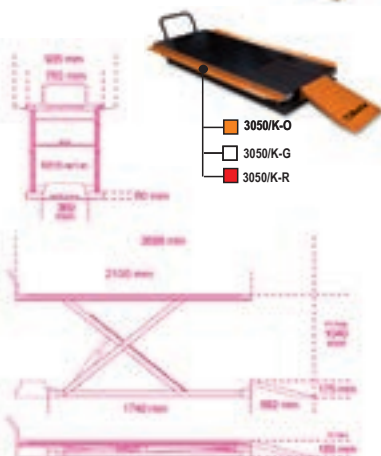

Características técnicas:

- . Dispositivos de segurança elétricos, mecânicos e hidráulicos;
- . Capacidade: 600kg
- . Unidade electro-hidráulica integrada: 1,1kW - 230V-7,4A-50Hz;
- . Bomba hidráulica com um fluxo ascendente de 2 l/min;
- . Velocidade descendente controlada por válvula, 1 l/min;
- . Válvula de segurança interrompe o fluxo de óleo em caso de corte accidental do tubo hidráulico;
- . Pode acomodar um dispositivo de controle manual com um cabo de 3m de comprimento;
- . Pinos montados em buchas auto-lubrificantes;
- . Êmbolo do pistão lubrificado durante cada ciclo, para maior vida útil;
- . Macaco com 7 posições mecânicas de segurança;
- . Certificado CE, aprovado pela TÜV

3050/K-O	4.360,00	1	030500101
3050/K-G	4.360,00	1	030500102
3050/K-R	4.360,00	1	030500103

### 3050/K2

Kit de extensão lateral para elevador 3050/K

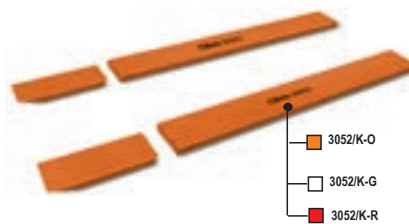

3050/K2-O	785,00	1	030500121
3050/K2-G	785,00	1	030500122
3050/K2-R	785,00	1	030500123

### 3050/M

Bloqueio de roda para elevador 3050/K



3050/M € 458,00 1 030500031

### 3051/LA

Tampo de metal para elevador 3050/K

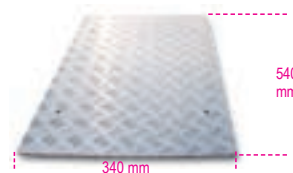

3051/LA € 77,50 1 030510061

### 3053

Trolley inferior para motocicletas

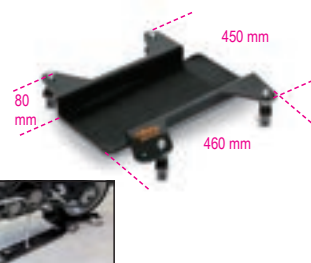

3053 € 177,00 1 030530001

### 3053/E

Extensão para descanso lateral para ref 3053



3053/E € 102,50 1 030530002



### 3055

Bloqueio automático de motocicletas para carrinhas  
Permite fixar a roda dianteira do motociclo



3055 € 251,00 1 030550001

### 3057

Rampa em alumínio para carregar e descarregar motocicletas

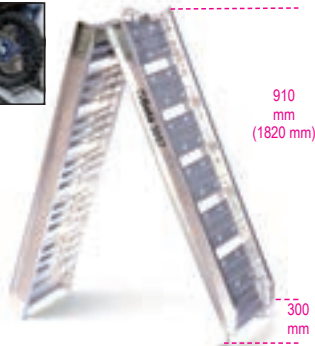

3057 € 324,00 1 030570001

### 3070

Equilibrador manual



- Permite equilibrar as rodas tanto nas oficinas como nas pistas de corrida;
- Equipado com rolamentos nível de bolha de nivelção e pesos ajustáveis para uma precisão exata;
- Vem com 2 cones para cubos;

3070 € 311,00 1 030700000

### 3070/1

Comparador para jantes, para ref. 3070



3070/1 € 44,00 1 030700001

### 3070/2

Kit de adaptadores para rodas monobraço, para ref 3070



3070/2 € 51,50 1 030700002

### 3070/3

Kit adaptador universal para scooters, para ref. 3070



3070/3 € 123,00 1 030700003

### 3070/4

Kit adaptador para motocicletas BMW, para ref. 3070



3070/4 € 127,00 1 030700004

### 3072

Compressores para molas e amortecedores



Inclui um kit de flange:  
74-45-47-50-53-56-59-62-68-71-75-77-80-84-87 mm

3072 € 1.058,00 1 030720001



### 3073

ferramenta universal para substituição dos O-rings de suspensão para tubos de diâmetro 35 ÷ 48 mm



3073 € 76,00 1 030730001

### 3075A

chave sextavada para eixo da roda



	Ø mm	L mm	€		
3075A 28	28	38	24,00	1	030750028
3075A 30	30	40	26,00	1	030750030

### 3075B

chave bi-sextavada para eixo de roda

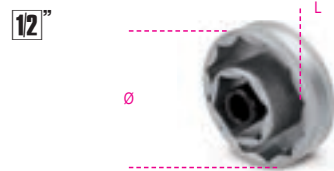

	Ø mm	L mm	€		
3075B 55	55	70,7	63,00	1	030750155

### 3075MV

Chave Bi-Sextavada para eixo de roda

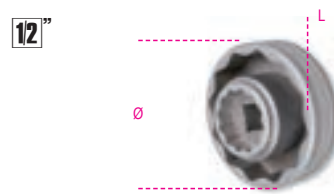

	Ø mm	L mm	€		
3075MV 56	56	70,7	71,00	1	030750156

### 3075/CM

chave sextavada múltipla para eixo da roda



3075/CM € 35,00 1 030750212

12-14-17-19-22-24 mm

### 3075/K10

kit com chave universal com cabeça intercambiável e 10 bits, para jantes

Tamanhos: 5.2 - 5.4 - 5.6 - 5.8 - 6.0 - 6.2 - 6.4 - 6.6 - 6.8 - 7.0



3075/K10 € 47,50 1 030750410

### 3079/21

lubrificador de cabos

Permite a lubrificação adequada dos cabos da embraiagem e do controlo de gás, para aumentar a suavidade do revestimento e duração do cabo.



3079/21 € 6,80 1 030790021

### 3080/C15

Kit abertura e cravagem de correntes

Ø 3-4-5 mm e kit Regina



3080/C15 € 313,00 1 030800015

420x185x60 mm

### 3080R/CS3

kit com 3 punhos de substituição para corrente 3080 / C15

Ø 3-4-5 mm



3080R/CS3 € 49,50 1 030800503

### 3081

ferramenta para cravar

Robusta e articulada, facilmente transportável. Adequada para correntes 415, 420, 428, 520, 525, 530, 532



3081 € 39,00 1 030810010

### 3085

ferramenta para recuar êmbolos dos travões

Adequada para motociclos e scooters



3085 € 87,00 1 030850010

### 3091

extrator de rosca interna para volante magnético



	M	€	1	
3091/10	24x1,5	18,00	1	030910010
3091/20	26x1,0	18,60	1	030910020
3091/30	28x1,0	19,10	1	030910030
3091/40	30x1,0	25,00	1	030910040
3091/45	30x1,5	25,00	1	030910045
3091/50	32x1,5	28,00	1	030910050
3091/60	33x1,5	29,50	1	030910060
3091/70	35x1,0	41,00	1	030910070
3091/75	35x1,5	41,00	1	030910075
3091/80	38x1,5	45,00	1	030910080

### 3092

extrator de rosca externa para volante magnético



	M	€	1	
3092/10	18x1,5	9,30	1	030920010
3092/20	19x1,0	10,90	1	030920020
3092/30	27x1,25	11,50	1	030920030
3092/35	22-26x1,5	11,50	1	030920035
3092/40	25x1,5	11,50	1	030920040
3092/50	26-28x1,0	11,50	1	030920050
3092/60	28x1,5	10,90	1	030920060

### 3093/E

ferramentas de bloqueio para prato de embraiagem, volante magnético e polias



3093/E € 32,00 1 030930100

### 3093/U

extrator múltiplo para volante magnético



	€	1	
3093/U	31,50	1	030930050
M10x1.25R			
M14x1.5R			
M16x1.5R			
M18x1.5R			
M24x1.0R			
M27x1.0L			



# FERRAMENTAS PARA BICICLETAS

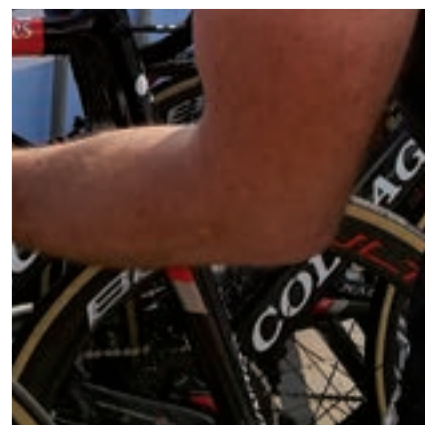
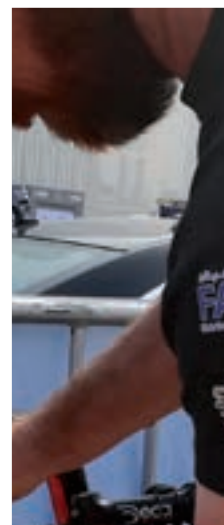
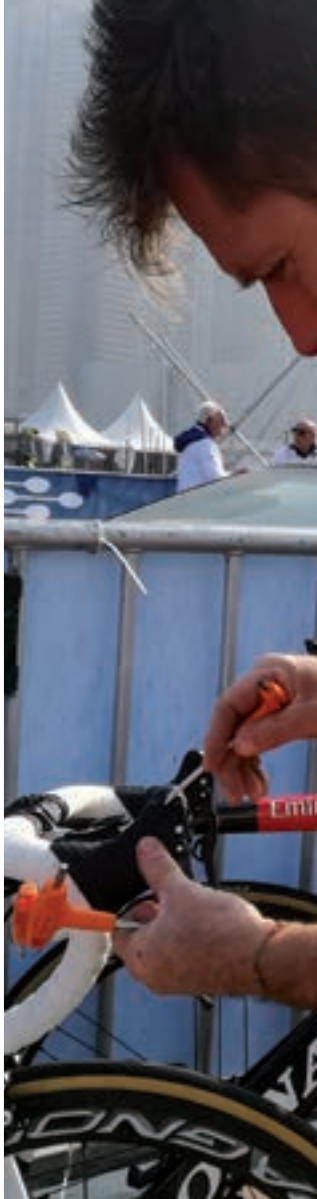

Partnership 2018 UAE Team Emirates



### 3912T

Bancada de trabalho TOP para manutenção de bicicletas

- Com suporte para movimentação central
- Gaveta de ferramentas



3912T € 1.194,00 1 039120010

### 3912P

Bancada de trabalho PRO

- Com suporte para movimentação central
- Gaveta de ferramentas



3912P € 682,00 1 039120110

### 3916MM

Bancada de trabalho PRO para manutenção de bicicletas

- Grampo com rotação a 360°



3916MM € 693,00 1 039160110

### 3921

Calibrador do suporte de mudanças

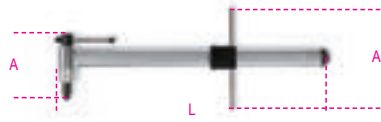

L mm	A mm	A1 mm	€	Q	Ref
440	115	165	93,00	1	039210010

### 3923

Grampo para corte de espigões do selim até 80mm e tubos 1" ÷ 1.1/2"

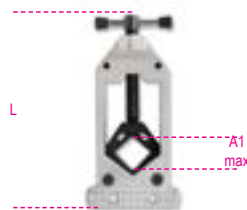

L mm	A1 max mm	Ø max mm	€	Q	Ref
160	80	45	41,50	1	039230010

### 3927

Grampo para guidador



3927 € 26,00 1 039270010

### 3932U

Ferramenta para correntes compatível com correntes de 5 a 11 velocidades



L mm	€	Q	Ref
164	49,50	1	039320011

### 3935

Ferramenta de verificação do desgaste das correntes



L mm	€	Q	Ref
120	8,20	1	039350010

### 3937

Alicate para elos de correntes



L mm	€	Q	Ref
170	21,30	1	039370010

### 3948

Extrator do crenque/braço do pedal

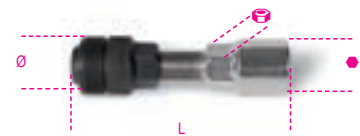

Ø mm	L mm	Ø mm	mm	€	Q	Ref
14	79	20	15	16,40	1	039480015

### 3952

Chave de cones simples



Ø mm	L mm	€	Q	Ref
13	205	21,30	2	039520013
14	205	21,30	2	039520014
15	205	21,30	2	039520015
16	205	21,30	2	039520016
17	205	21,30	2	039520017
18	205	21,30	2	039520018
19	205	21,30	2	039520019
20	205	21,80	1	039520020
21	205	21,80	1	039520021
22	205	21,80	1	039520022
24	205	22,40	1	039520024



Ref	€	Q	Ref
3952/S7 13-14-15-16 17-18-19 mm	149,00	1	039520207



**3953**

Chave de boca para pedais



mm	L	€		
15	401	33,00	1	039530015

**3955**

Chave de bocas para caixas de direção universais



mm	L	€		
30x32	292	31,00	1	039550108
32x36	319	34,00	1	039550114

**3961 3,2**

Chave para raios, preta, 3.2 mm



mm	€		
3,2	12,00	1	039610032

**3961 3,3**

Chave para raios, verde, 3.3 mm



mm	€		
3,3	12,00	1	039610033

**3961 3,5**

Chave para raios, vermelha, 3.5 mm



mm	€		
3,5	12,00	1	039610035

**3961U**

Chave múltipla para raios, 3.2 - 4.0 mm



mm	€		
3,2 - 4,0	19,70	1	039610100

**3962SH**

Chave dupla para raios Shimano



L	A1	A2	€		
mm	mm	mm	14,80	1	039620010
132	4,3	4,4			

**3962MV**

Chave dupla para raios Mavic



L	A1	A2	€		
mm	mm	mm	15,30	1	039620020
135	4,3	8,4			

**3963P**

Chave especial para raios planos



L	€		
mm	7,10	1	039630010
129			

**3964**

Chave especial para cabeça do raio



L	L1	€		
mm	mm	17,50	1	039640010
170	89			

**3965**Verificador de alinhamento das rodas,  $\varnothing$  20"  $\div$  29"

L	€		
mm	98,50	1	039650010
680			

**3965C**

Suporte para alinhar rodas

- Adequado para rodas  $\varnothing$  20"  $\div$  29" (29" sem pneu)
- Através de adaptador para cubo do eixo, 10  $\div$  20mm



L	L1	A	€		
mm	mm	mm	349,00	1	039650110
500	380	285			

**3967**

Ferramenta de bloqueio da cremalheira

- Adequado para cremalheiras até 11 carretos
- Punho em PVC bicomponente
- Também adequado para cremalheiras fixas



L	€		
mm	43,00	1	039670010
289			

**3969**

Alavanca metálica de pneus



L	A	€		
mm	mm	8,75	1	039690010
200	15,6			

**3969K3**

Kit de 3 alavancas de plástico, para pneus



L	€		
mm	4,95	1	039690130
113			

**3971**

Chave para parafusos de plástico Shimano

- Adequado para Shimano Hollowtech II crankssets



N°	mm	€		
8	8	10,40	1	039710010

**3972**

Chave de extração do eixo de tração

- Adequado para Shimano® Hollowtech II, Campagnolo® Ultra-torque, FSA®, SRAM®



L mm	€	1	039720010
252	20,80		

**3973PF**

Extrator de rolamentos Press-Fit

- Adequada para Ø interiores 24 mm e 30 mm



L mm	€	1	039730001
240	27,50		

**3973/1**

Chave de extração do eixo de tração com 16 entalhes

- Adequado para Shimano® XTR BB93, Dura-Ace® BB9000

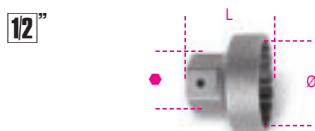

Ø mm	● mm	L mm	€	1	039730010
39	24	34	17,50		

**3973/2**

Chave de extração do eixo de tração com 16 entalhes

- Adequado para Shimano® BBR60 (Ultegra® 11 speeds)



Ø mm	● mm	L mm	€	1	039730020
41	24	35	17,50		

**3973/3**

Chave de extração do eixo de tração com 16 entalhes

- Adequado para Shimano® Hollowtech II, Campagnolo® Ultra-torque, FSA®, SRAM®

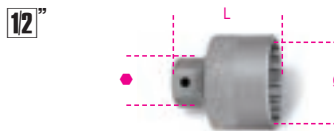

Ø int. mm	● mm	L mm	€	1	039730030
46	24	53,5	17,50		

**3973/4**

Chave extração do eixo de tração com 20 entalhes, com pino central, niquelada

- Adequado para Shimano e ISIS



Ø mm	L mm	● mm	€	1	039730040
31,5	55	24	10,90		

**3975**

Prensa de montagem de rolamentos

- Para montagem de caixas de direção, compatível com 1", 1.1/8", 1.1/4", 1.1/2" and 2"



L mm	Ø mm	€	1	039750010
360	16x1	232,00		

**3984/1**

Chave de extração de cremalheira BMX, 4 pinos

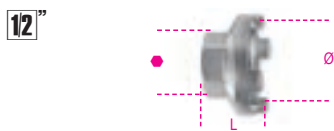

Ø mm	L mm	● mm	€	1	039840010
35	25,5	24	13,10		

**3984/2**

Chave de extração de cremalheira Shimano



Ø mm	L mm	● mm	€	1	039840020
22,8	26	24	8,20		

**3984/3**

Chave de extração de cremalheira Shimano, cassete com pino guia

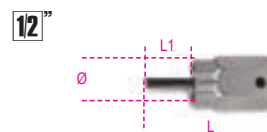

Ø mm	L mm	L1 mm	€	1	039840030
23,5	65	25	14,20		

**3984/4**

Chave de extração de cremalheira Campagnolo, com pino guia



Ø mm	L mm	L1 mm	● mm	€	1	039840040
23	51	13	24	18,60		

**3984/5**

Chave de extração de cremalheira, 2 pinos



Ø mm	L mm	● mm	€	1	039840050
18,5	38	21	13,10		

**3984/6**

Chave de extração de cremalheira, 4 pinos



Ø mm	L mm	● mm	€	1	039840060
19,5	36	21	13,10		

**3991**

Alavanca para os freios do disco de travão



L mm	A mm	α	€	1	039910010
222	36	7°	25,00		

**3992**

Alinhador de discos de travão



L mm	A1 mm	€	1	039920010	
234	4 55	2,2	22,90		



# FERRAMENTAS ISOLADAS

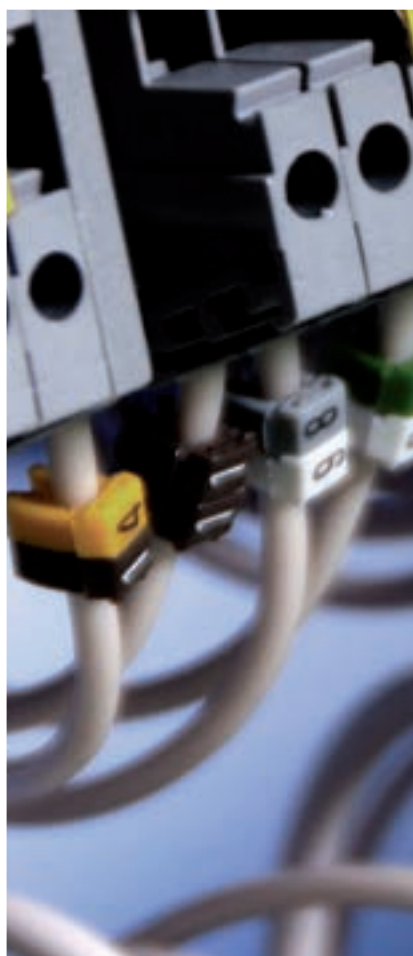

## 1000 V

As ferramentas isoladas Beta Utensili destinam-se a garantir a segurança nos trabalhos de instalação e manutenção eléctrica.

Todas as ferramentas isoladas possibilitam trabalhar em sistemas de corrente alternada até 1000V e até 1500V em corrente contínua. Para fornecer a melhor qualidade nos padrões de desempenho e possuir a adequada conformidade com a norma EN 60900, cada ferramenta é submetida a testes rigorosos: resistência a escorregamento dos punhos, propagação de chamas e teste de alta tensão(10000V).

Para jogos e módulos de ferramentas, consultar as respectivas secções.

Todas as ferramentas isoladas Beta são fabricadas de acordo com as especificações da EN60900 e aprovadas pelas principais instituições de certificação europeias



Istituto Italiano del Marchio di Qualità - I



Verband der Elektrotechnik  
Elektronik Informationstechnik - D

## 52MQ

chaves de bocas simples isoladas



EN 60900

Ø	L	€	U	Art.
mm	mm			
10	110	29,00	1	000520110
11	120	29,00	1	000520111
12	132	31,00	1	000520112
13	140	32,00	1	000520113
14	146	33,00	1	000520114
15	166	34,00	1	000520115
17	168	36,00	1	000520117
19	176	37,50	1	000520119
22	200	40,50	1	000520122
24	225	45,50	1	000520124

## 89MQ

chaves de luneta



EN 60900

Ø	L	€	U	Art.
mm	mm			
10	170	36,00	1	000890110
11	180	37,50	1	000890111
12	190	41,00	1	000890112
13	195	43,00	1	000890113
14	200	45,50	1	000890114
15	210	47,00	1	000890115
17	218	50,00	1	000890117
19	240	52,00	1	000890119
22	255	60,50	1	000890122
24	280	69,00	1	000890124

## 110MQ

chave de abertura variável com escala



EN 60900

L	A	€	U	Art.
mm	max			
200	28	71,00	1	001100520
250	30	84,00	1	001100525

## 606MQ/50

chave dinamométrica com desarme sonoro e com roquete reversível



EN 60900

UNI EN 26789  
ISO 6789

Nm	Kgfm	lbf.ft	A	L	Ø
5=50	0,5=5	4=40	mm	mm	mm
			90	375	1130

606MQ/50	€	U	Art.
	704,00	1	006060705

## 850MQ

porta bits magnético, isolado, com punho de 2 componentes



IMQ CSV

L	L1	D	€	U	Art.
mm	mm	mm			
233	125	12,5	20,80	1	008500910

## 920MQ/A

chaves de caixa bocas hexagonais



EN 60900

Ø	L	Ø1	€	U	Art.
mm	mm	mm			
8	21,5	57	27,5	26,00	1 009200238
9	21,5	57	27,5	26,00	1 009200239
10	21,5	57	27,5	26,00	1 009200240
11	21,5	57	27,5	26,00	1 009200241
12	23,0	57	27,5	26,00	1 009200242
13	23,0	57	27,5	26,00	1 009200243
14	23,0	57	27,5	27,50	1 009200244
16	23,0	57	27,5	28,00	1 009200246
17	30,0	57	27,5	28,00	1 009200247
18	32,0	57	27,5	28,50	1 009200248
19	32,2	57	27,5	28,50	1 009200249
20	32,0	57	27,5	32,00	1 009200250
22	36,0	57	27,5	32,00	1 009200252
24	39,0	57	27,5	33,00	1 009200254

## 920MQ/PE

chaves de caixa para parafusos sextavados



EN 60900

Ø	L	L1	€	U	Art.
mm	mm	mm			
5	28,5	94,5	10,5	45,00	1 009200265
6	28,5	94,5	10,5	45,00	1 009200266
8	28,5	94,5	10,5	45,00	1 009200268
10	28,5	94,5	10,5	47,00	1 009200267
12	28,5	94,5	10,5	47,00	1 009200269

## 920MQ/21

extensão com quadras macho e fêmea de 1/2"



EN 60900

L	Ø	€	U	Art.
mm	mm			
135	28	51,00	1	009200804

## 920MQ/22

extensão com quadras macho e fêmea de 1/2"



EN 60900

L	Ø	€	U	Art.
mm	mm			
264	30	58,00	1	009200805

## 920MQ/T

punho em T com quadra macho de 1/2"

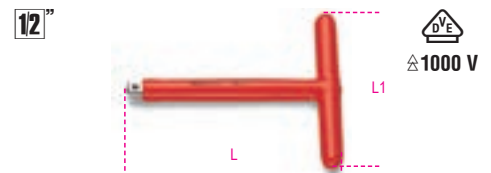

EN 60900

L	L1	€	U	Art.
mm	mm			
200	163	60,50	1	009200807

## 920MQ/55A

roquete reversível com quadra macho de 1/2" com sistema de bloqueio



EN 60900

L	D	A	€	U	Art.
mm	mm	mm			
240	50	89	218,00	1	009200809

## 920MQ/C16

9 chaves de caixa sextavadas, 3 pontas para parafusos sextavados e 4 acessórios



EN 60900

920MQ/C16	€	U	Art.
	821,00	1	009200917

920MQ/A	8 - 10 - 12 - 13 - 14 - 17 - 19 - 22 - 24 mm
920MQ/PE	5 - 6 - 8 mm
920MQ/21	135 mm
920MQ/22	264 mm
920MQ/55A	
920MQ/T	
420x280x60 mm - 5,2 kg	

## 943MQ

chaves de caixa com punho boca hexagonal

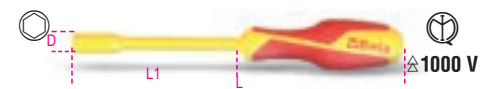

EN 60900

Ø	L	L1	D	€	U	Art.
mm	mm	mm	mm			
5,5	233	125	12,2	16,40	1	009430235
6	233	125	12,5	16,40	1	009430236
7	240	125	14,3	17,50	1	009430237
8	240	125	15,3	18,00	1	009430238
10	252	125	17,3	18,60	1	009430240
13	252	125	21,3	20,20	1	009430243

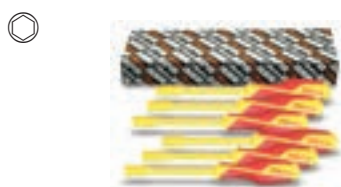

943MQ/S6  
5,5-6-7-8-10-13 mm

€ 107,00 1 009430250

### 951MQ

chaves macho hexagonal  
com punho em T



EN 60900

mm	L mm	L1 mm	€	1	009510704
4	165	105	43,00	1	009510704
5	170	105	43,00	1	009510705
6	168	105	43,00	1	009510706
8	165	105	45,00	1	009510708

### 993MQ

pinça com pontas curvas estriadas



EN 60900

L mm	€	1	009930040
147	36,00	1	009930040

### 994MQ

pinça com pontas curvas estriadas



EN 60900

L mm	€	1	009940040
145	34,00	1	009940040

### 1010MQ

alicates de pontas longas redondas



EN 60900

L mm	L1 mm	€	1	010100096
160	51,5	43,00	1	010100096

### 1048MQ

Alicate ajustável, charneira fechada, isolado  
acabamento cromado

• Acabamento cromado



EN60900

L mm	A max mm	L1 mm	€	1	010480315
250	48	39	63,50	1	010480315

### 1082MQ

alicates de corte diagonal



EN 60900

L mm	L1 mm	mm	€	1	010820094
140	20	1,6	41,50	1	010820094
160	22	1,6	44,50	1	010820096

### 1084MQ

alicates de corte de diagonal  
para serviços pesados



EN 60900

L mm	L1 mm	mm	€	1	010840100
200	26	2,0	56,00	1	010840100

### 1088MQ

alicates de corte frontal



EN 60900

L mm	L1 mm	mm	€	1	010880096
160	7	1,6	52,00	1	010880096

### 2115P L-MQ32



2115PL-MQ32

278

### 1128MQ

tesoura de electricista,  
lâminas em aço inox,  
com microdentes



IEC60900

L mm	L1 mm	€	1	011280101
145	45	44,00	1	011280101

### 1132MQ

alicate para cortar cabos de cobre e alumínio,  
com punhos isolados



EN 60900

L mm	mm	€	1	011320193
230	18	81,00	1	011320193

### 1142MQ

alicate de descarnar fio



EN 60900

L mm	mm <sup>2</sup>	€	1	011420096
160	0,5÷6	47,50	1	011420096

### 1150MQ

alicates universais em cromado brilhante



EN 60900

L mm	L1 mm	mm	€	1	011500096
160	37	1,6	40,00	1	011500096
180	39	1,8	43,50	1	011500098
200	43	2,0	46,00	1	011500100
220	46	2,0	49,00	1	011500102

### 1162MQ

alicates de pontas extra-longas chatas



EN 60900

L mm	L1 mm	mm	€	1	011620096
160	56	1,6	43,00	1	011620096
200	76	1,6	46,00	1	011620100

## 1164MQ

alicate de pontas curvas chatas extra-longas

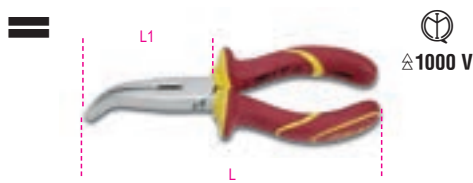

L mm	L1 mm	mm	€	U	EN
160	54	1,6	44,50	1	011640096
200	76	1,6	48,00	1	011640100

## 1166MQ

alicates de pontas semi-redondas extra-longas



L mm	L1 mm	mm	€	U	EN
160	56	1,6	43,00	1	011660096
200	76	1,6	46,00	1	011660100

## 1168MQ

alicates de pontas curvas semi-redondas extra-longas



L mm	L1 mm	mm	€	U	EN
160	50	1,6	44,50	1	011680096
200	70	1,6	48,00	1	011680100

## 1272MQ/F

Chaves para parafusos de perfil Phillips®

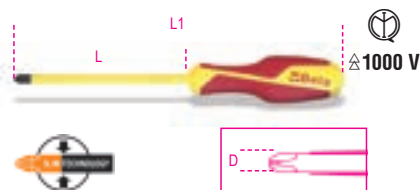

EN60900

PHxDxL mm	L1 mm	€	U	EN
1x4.5x80	187	11,50	3	012720409
2x6x100	218	13,10	3	012720418

## 1272MQ

chaves para parafusos de perfil Phillips®

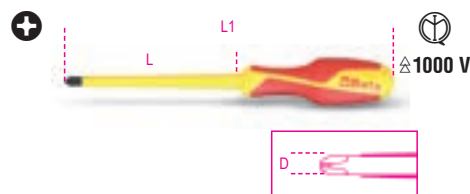

EN 60900

PHxDxL mm	L1 mm	€	U	EN
0x3x60	160	8,55	3	012720703
1x4,5x80	187	10,40	3	012720709
2x6x100	218	12,00	3	012720718
3x8x150	276	15,30	2	012720724
4x10x200	326	18,00	2	012720727



1272MQ/S5	€	U	EN
PH0x3x60-PH1x4,5x80 PH2x6x100-PH3x8x150 PH4x10x200 mm	64,50	1	012720751

## 1273MQ/F-D6

Conjunto de 6 chaves de parafusos



1273MQ/F-D6	€	U	EN
	70,50	1	012730406

1274MQ/F	0,5x3,5x100 - 0,8x4,5x100 - 1x5,5x125 - 1,2x6,5x150 mm
1272MQ/F	PH1x4,5x80- PH2x6x100 mm

## 1273MQ/D6

jogo de 6 chaves de fenda



1273MQ/D6	€	U	EN
	60,50	1	012730851

1274MQ	0,5x3x100 -0,8x4x100 1,0x5,5x125 mm
1272MQ	PH0x3x60 -PH1x4,5x80 PH2x6x100 mm

## 1274MQ/F

Chave para parafusos de fenda sem cabeça  
espessura reduzida

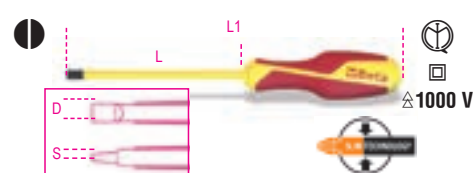

EN60900

SxDxLmm	L1 mm	€	U	EN
0.5x3.5x100	200	9,40	3	012740403
0.8x4.5x100	205	10,60	3	012740406
1x5.5x125	232	12,00	3	012740409
1.2x6.5x150	268	14,10	3	012740412

## 1274MQ

chaves para parafusos de perfil  
de fenda sem cabeça

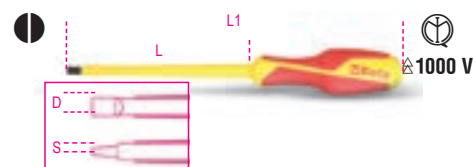

EN 60900

SxDxL mm	L1 mm	€	U	EN
0,4x2,5x75	175	8,20	3	012740700
0,5x3x100	200	8,65	3	012740703
0,8x4x100	207	9,95	3	012740706
1x5,5x125	232	10,90	3	012740709
1,2x6,5x150	268	13,00	3	012740712
1,2x8x175	301	15,60	2	012740715
1,6x10x200	326	18,00	2	012740718

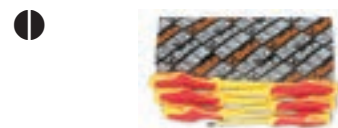

1274MQ/S6	€	U	EN
	76,00	1	012740751

0,5x3x100-0,8x4x100 1x5,5x125-1,2x6,5x150 1,2x8x175-1,6x10x200 mm
---

## 1275MQ/C

Chave combinada para parafusos de fenda +  
cabeça em cruz PH  
espessura reduzida



EN60900

	€	U	EN
PH1+LPP	11,80	2	012750409
PH2+LPP	13,50	2	012750418

## 1276MQ/C

Chave combinada de parafusos PZ + cabeça com fenda  
espessura reduzida



	€		
☉ PZ1+LPP	11,80	2	012760409
☉ PZ2+LPP	13,50	2	012760418

## 1279MQ/F

Chave de parafusos Pozidriv®-Supadriv®

espessura reduzida

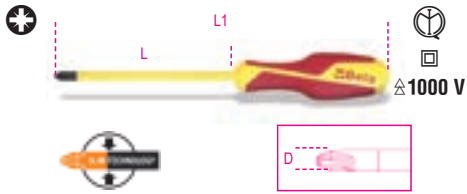

EN60900

pz	L mm	L1 mm	€		
1	80	187	11,50	3	012790409
2	100	218	13,10	3	012790418

## 1279MQ

chave de fenda para parafuso de perfil Pozidriv® - Supadriv®



EN 60900

PZ	L mm	L1 mm	€		
0	60	160	8,85	3	012790703
1	80	187	10,60	3	012790709
2	100	218	12,40	3	012790718
3	150	276	15,90	2	012790724

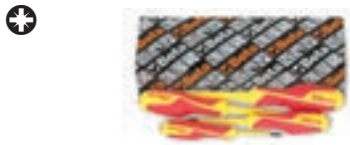

1279MQ/S4 PZ 0-1-2-3	€ 47,50		1	012790751
-------------------------	---------	--	---	-----------

## 1725MQ

mini serrote



	L mm	H mm	€		
1725MQ	260	85	82,00	1	017250030

## 1777MQ/C

navalha de descarnar cabo, isolada

• para cabos multi-núcleos



	L mm	€		
1777MQ/C	190	33,00	1	017770026

## 1777MQ/U

navalha de descarnar cabo, isolada



	L mm	€		
1777MQ/U	190	28,50	1	017770011

## 1777RL/U

4 lâminas de substituição para 1777MQ/U

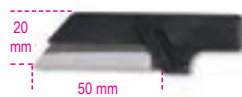

1777RL/U	€ 23,50		1	017770021
----------	---------	--	---	-----------

## 1995MQ/T

tapete isolante

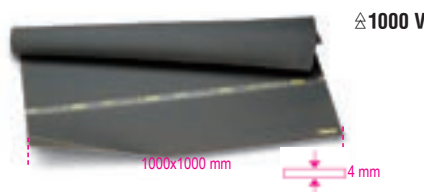

VDE 0303

	LxSxH mm	€		
1995MQ/T	1000x1000x4	273,00	1	019950030

## 1995MQ/G1 - G2

luvas isolantes em látex



EN 60903

	Gr.	L mm	€		
1995MQ/G1	9	410	108,50	1	019950010
1995MQ/G2	10	410	108,50	1	019950013

# Beta



# FERRAMENTAS ANTI-QUEDA

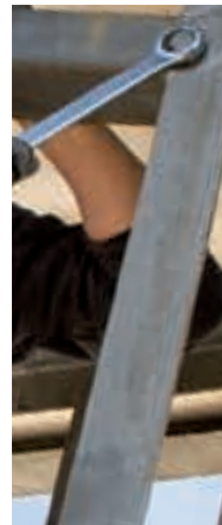

## **Beta H-SAFE**

A gama de ferramentas H-SAFE de Beta inclui mais de 200 referências, para as quais foi projetado individualmente um sistema de retenção capaz de resistir às solicitações mecânicas mais rigorosas, como garantia de máxima segurança.

O conforto na utilização também é importante, nas chaves com utilização das duas extremidades, como a chave de boca/luneta art. 42, existe um cabo se movimenta ao longo de todo o corpo da ferramenta (foto), enquanto nas ferramentas manobradas com torção, por exemplo a chave de parafuso, existem anéis de rotação livre para não causar torção do cabo.



O sistema de retenção H-SAFE foi projetado, testado e fabricado nas unidades industriais Beta

Com o sistema de segurança H-SAFE de Beta as ferramentas estão sempre ao alcance da mão de forma confortável e segura

## 35HS

escopros planos série nervurada H-SAFE



L mm	A mm	€	🔧	📄
200	23,0	35,00	1	000354004
250	28,5	43,50	1	000354005

## 42HS

chaves mistas boca/luneta H-SAFE



DIN 3113 UNI-ISO 7738

🔧 mm	L mm	€	🔧	📄
6x6	95	18,00	1	000424006
7x7	105	18,10	1	000424007
8x8	116	18,40	1	000424008
9x9	127	18,80	1	000424009
10x10	137	19,00	1	000424010
11x11	148	19,70	1	000424011
12x12	158	19,90	1	000424012
13x13	169	20,00	1	000424013
14x14	180	20,50	1	000424014
15x15	190	21,20	1	000424015
16x16	201	21,80	1	000424016
17x17	212	22,70	1	000424017
18x18	222	23,30	1	000424018
19x19	233	23,80	1	000424019
20x20	243	24,90	1	000424020
21x21	254	26,00	1	000424021
22x22	264	26,50	1	000424022
23x23	275	27,50	1	000424023
24x24	285	29,00	1	000424024
25x25	296	29,50	1	000424025
26x26	307	31,00	1	000424026
27x27	317	33,00	1	000424027
28x28	328	33,50	1	000424028
29x29	338	36,00	1	000424029
30x30	349	37,50	1	000424030
32x32	370	41,00	1	000424032
34x34	391	67,50	1	000424034
36x36	412	75,00	1	000424036

## 42HS/AS

chaves mistas boca/luneta H-SAFE



🔧 "	L mm	€	🔧	📄
1/4x1/4	95	19,30	1	000424106
5/16x5/16	116	19,60	1	000424108
3/8x3/8	137	20,40	1	000424110
7/16x7/16	148	21,30	1	000424111
1/2x1/2	169	21,20	1	000424113
9/16x9/16	180	21,80	1	000424114
5/8x5/8	201	23,50	1	000424116
11/16x11/16	212	24,60	1	000424117
3/4x3/4	233	25,50	1	000424119
13/16x13/16	254	28,50	1	000424121
7/8x7/8	264	29,00	1	000424122
15/16x15/16	285	32,50	1	000424124
1x1	296	33,50	1	000424125
1.1/16x1.1/16	317	36,00	1	000424127
1.1/8x1.1/8	338	38,50	1	000424129
1.1/4x1.1/4	370	46,00	1	000424132
1.5/16x1.5/16	391	69,50	1	000424133

## 55HS

chaves de bocas H-SAFE



UNI-ISO 10102 DIN 3110

🔧 mm	L mm	€	🔧	📄
• 6x7	120	14,10	1	000554012
• 8x9	140	14,70	1	000554021
• 10x11	155	15,10	1	000554030
• 12x13	170	15,90	1	000554042
• 14x15	185	16,40	1	000554054
• 16x17	202	17,50	1	000554060
• 18x19	220	18,50	1	000554066
• 20x22	236	19,70	1	000554075
• 21x23	245	20,50	1	000554078
22x24	245	22,40	1	000554081
24x27	262	24,60	1	000554090
• 30x32	297	31,00	1	000554108
34x36	325	69,00	1	000554117

## 91HS-C

chaves de luneta inclinada para serviços pesados H-SAFE



🔧 mm	Ø mm	€	🔧	📄
36	54	84,00	1	000914036
41	62	98,50	1	000914041
46	69	113,00	1	000914046

## 91HS

chaves de luneta inclinada para serviços pesados H-SAFE



🔧 mm	Ø mm	€	🔧	📄
36	54	165,00	1	000914236
41	62	179,00	1	000914241
46	69	211,00	1	000914246

## 92HS

cabo tubular para a chave refª. 91 H-SAFE



L mm	91 mm	Ø mm	€	🔧	📄
610	32÷41	22	81,00	1	000924020
760	46÷55	25	98,50	1	000924030

## 93HS

chave de lunetas com curvatura profunda especial para andaimes H-SAFE



🔧 mm	L mm	€	🔧	📄
21x22	310	49,50	1	000934021

## 96THS

chaves macho hexagonal com punho H-SAFE



mm	L mm	L1 mm	€	🔧	📄
2,5	153	55	21,30	1	000964935
3	153	55	21,80	1	000964936
4	179	70	22,40	1	000964938
5	200	84	22,90	1	000964940
6	221	103	24,60	1	000964941
8	255	117	29,00	1	000964943
10	285	132	32,00	1	000964945

## 96THS-AS

chaves macho hexagonal com punho H-SAFE



🔧 "	L mm	L1 mm	Ø mm	€	🔧	📄
5/32	200	84	6	24,60	1	000964673
3/16	200	84	6	24,60	1	000964674
7/32	221	103	7	27,00	1	000964675
1/4	236	106	8	28,00	1	000964676
5/16	255	117	10	31,00	1	000964678
3/8	285	132	12	34,00	1	000964680



## 97TTXHS

chaves duplas macho com punho para parafusos com cabeça Torx® H-SAFE

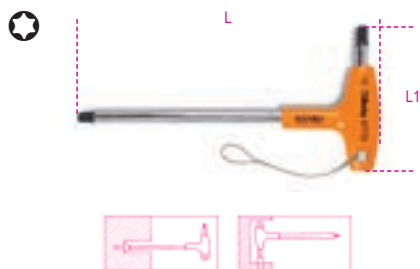

Ø	L mm	L1 mm	€	U	PC
T10	179	70	21,80	1	000974710
T15	179	70	22,40	1	000974715
T20	179	70	22,90	1	000974720
T25	179	70	23,50	1	000974725
T30	200	84	26,00	1	000974730
T40	221	103	28,50	1	000974740
T45	236	106	31,50	1	000974745
T50	255	117	37,50	1	000974750

## 111HS

chaves ajustáveis com escala, cromadas H-SAFE

- Rotação direita do pino
- Com escala em mm e polegadas



DIN 3117 ISO 6787

L mm	L" mm	A max mm	A1 mm	€	U	PC
200	8	28	62,0	41,50	1	001114020
250	10	34	70,0	48,00	1	001114025
300	12	35	84,0	59,00	1	001114030
380	15	45	97,0	101,50	1	001114038
450	18	54	115,0	159,00	1	001114045

## 142HS

chaves boca/luneta com sistema de roquete H-SAFE



Ø mm	L mm	€	U	PC
8x8	136	27,50	1	001424008
9x9	143	28,50	1	001424009
10x10	159	29,00	1	001424010
11x11	168	29,50	1	001424011
12x12	174	30,00	1	001424012
13x13	180	31,50	1	001424013
14x14	190	32,00	1	001424014
15x15	200	33,50	1	001424015
16x16	216	35,50	1	001424016
17x17	233	36,00	1	001424017
18x18	239	38,50	1	001424018
19x19	248	39,00	1	001424019
21x21	285	47,00	1	001424021
22x22	285	48,00	1	001424022
24x24	325	54,50	1	001424024
27x27	355	73,50	1	001424027
30x30	420	84,50	1	001424030
* 32x32	420	87,50	1	001424032

## 360HS

chaves para tubos modelo Stillson H-SAFE



L mm	Ø max* mm	€	U	PC
250	1" gas	45,00	1	003604025
350	1 1/2" gas	56,00	1	003604035
450	2" gas	72,00	1	003604045
600	2 1/2" gas	104,00	1	003604060

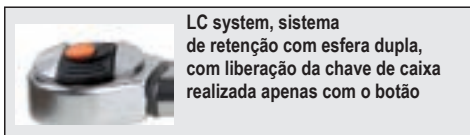

LC system, sistema de retenção com esfera dupla, com liberação da chave de caixa realizada apenas com o botão

## 666HS

Chaves dinamométricas com roquetes reversíveis, para aperto à direita, precisão de torque: ±3%



Nm	Kgfm	lbf.ft	□	D mm	A mm	L mm	g
10÷50	1÷5	7÷37	3/8	30	33	312	660

666HS/5 235,00 1 006664005

Nm	Kgfm	lbf.ft	□	D mm	A mm	L mm	g
20÷100	2÷10	15÷75	3/8	30	33	381	730

666HS/10 239,00 1 006664010

Nm	Kgfm	lbf.ft	□	D mm	A mm	L mm	LC system*	g
40÷200	4÷20	30÷150	1/2	40	43	470	1010	

666HS/20LC 269,00 1 006664021

Nm	Kgfm	lbf.ft	□	D mm	A mm	L mm	LC system*	g
60÷300	6÷30	50÷220	1/2	40	43	598	1380	

666HS/30LC 300,00 1 006664031

## 900E-HS/55

roquete reversível H-SAFE



L mm	Ø mm	A mm	□	€	U	PC
125	25	18	1/4	41,50	1	009004880

## 910E-HS/55

roquete reversível H-SAFE



L mm	Ø mm	A mm	□	€	U	PC
200	30	33	3/8	49,00	1	009104880

## 920E-HS/55LC

roquete reversível H-SAFE com "Locking system"



L mm	Ø mm	A mm	□	€	U	PC
275	40	43	1/2	71,50	1	009204860

## 932HS

chaves de cachimbo 6 faces/12 faces em cromado brilhante H-SAFE

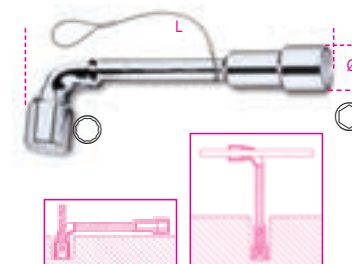

NF E 74.303

Ø mm	Ø mm	L mm	€	U	PC
6x6	11,5	110	24,00	1	009324006
7x7	12,5	116	24,40	1	009324007
8x8	13,0	120	25,50	1	009324008
9x9	14,0	125	25,50	1	009324009
10x10	16,5	133	26,00	1	009324010
11x11	17,5	143	28,00	1	009324011
12x12	19,0	148	29,00	1	009324012
13x13	19,5	154	29,50	1	009324013
14x14	21,5	167	31,50	1	009324014
15x15	22,5	182	32,50	1	009324015
16x16	24,5	193	33,50	1	009324016
17x17	26,0	198	33,50	1	009324017
18x18	26,5	215	35,50	1	009324018
19x19	29,0	220	38,50	1	009324019



## 1032HS

alicates de freios interiores com pontas direitas e punhos em PVC H-SAFE



UNI 7914 DIN 5256

L	Ø	Ø1	A	€	🔧	📄
mm	mm	mm	mm			
140x1,3	12÷25	1,3	20	33,00	1	010324014
180	19÷60	1,9	21	34,50	1	010324017

## 1034HS

alicates de freios interiores com pontas curvas a 90° e punhos em PVC H-SAFE



UNI 7914 DIN 5256

L	Ø	Ø1	A	€	🔧	📄
mm	mm	mm	mm			
170	19÷60	1,9	21	37,00	1	010344017

## 1036HS

alicates de freios exteriores com pontas direitas e punhos de PVC H-SAFE



UNI 7915 DIN 5254

L	Ø	Ø1	A	€	🔧	📄
mm	mm	mm	mm			
140x1,3	10÷25	1,3	20	34,50	1	010364014
175	19÷60	1,9	21	35,50	1	010364017

## 1038HS

alicates de freios exteriores com pontas curvas a 90° e punhos em PVC H-SAFE



UNI 7915 DIN 5254

L	Ø	Ø1	A	€	🔧	📄
mm	mm	mm	mm			
175	19÷60	-	21	38,00	1	010384017

## 1048BM-HS

alicate ajustável, charneira fechada, punhos de 2 componentes H-SAFE

· novo modelo com 9 posições



L	A max	L1	g	€	🔧	📄
mm	mm	mm				
250	48	39	460	54,00	1	010484215

## 1052HS

alicates de pressão, maxilas côncavas H-SAFE

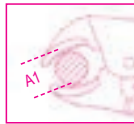

L	A	A1 max	S	€	🔧	📄
mm	mm	mm	mm			
240	72	42	10,0	43,00	1	010524024

## 1082BM-HS

alicates de corte diagonal, punhos bi-material H-SAFE



UNI/ISO 5749

L	L1	mm	A	€	🔧	📄
mm	mm	mm	mm			
160	22	1,6	28,0	43,50	1	010824036

# Beta

## 1088BM-HS

alicates de corte frontal para serviços pesados, punhos bi-material H-SAFE



UNI/ISO 5748

L	L1	mm	A	€	🔧	📄
mm	mm	mm	mm			
160	9	1,6	28,0	51,00	1	010884036
200	11	2,0	36,0	64,00	1	010884040

## 1128BAX-HS

Tesoura de electricista com perfis de escareação graduados, lâminas em aço inox com revestimento DLC H-SAFE

Gumes de corte duplo: pino excêntrico especial permite que as lâminas se movimentem a todo o comprimento, aumentando a eficiência de corte. H-SAFE

Concebida para alargar furos em plástico, de 13 mm a 25 mm.

Revestimento DLC (diamond-like carbon) é um revestimento inovador à base de carbono: a elevada dureza e baixo atrito resultam da combinação de carbono, sob a forma de grafite, e diamante.

- Elevada dureza da superfície da lâmina (resistência à abrasão e desgaste)
- Baixa fricção (suavidade e antiaderência)
- Pino excêntrico especial
- Punhos de grandes dimensões com ranhura para corte de cabos e cravagem de terminais
- Com caixa em plástico articulada
- Patentada



L	L1	mm²	€	🔧	📄
mm	mm	mm²			
150	50	50	39,50	1	011284088

# Beta

## 1132BM-HS

corta-cabos para cabos isolados de cobre e alumínio com punhos bi-material H-SAFE



UNI 8791

L	mm	A	B	€	1	011324143
230	18	37	12,5	78,00	1	011324143

## 1150BM-HS

alicates universais em madeira brilhante com punhos bi-material H-SAFE



ISO 5746

L	L1	mm	A	€	1	011504036
160	37	1,6	24,0	38,50	1	011504036
180	41	1,8	28,0	40,50	1	011504038
200	45	2,0	32,0	43,50	1	011504040

## 1166BM-HS

alicates de pontas semi-redondas com estrias, extra-longas, e punhos bi-material H-SAFE



ISO 5745

L	L1	mm	A	€	1	011664040
200	76	1,6	22,0	45,50	1	011664040

## 1168BM-HS

alicates de pontas curvas semi-redondas com estrias, extra-longas, e punhos bi-material H-SAFE



ISO 5745

L	L1	mm	A	€	1	011684040
200	70	1,6	22,0	48,00	1	011684040

## 1290HS

chaves para parafusos de perfil de fenda H-SAFE



ISO 2380

SxAxL	L1	Ø	€	1	012904006
0,4x2,5x75	171	2,5	15,30	1	012904006
0,5x3x100	196	3,0	15,90	1	012904012
0,6x3,5x100	196	3,5	17,20	1	012904021
0,8x4x100	196	4,0	16,80	1	012904030
0,8x4x150	246	4,0	18,00	1	012904036
1x5,5x150	259	5,0	20,20	1	012904042
1,2x6,5x150	270	6,0	21,30	1	012904051
1,2x8x150	282	7,0	24,00	1	012904057
1,6x10x200	332	8,0	27,50	1	012904066

## 1292HS

chaves para parafusos de perfil Phillips® H-SAFE

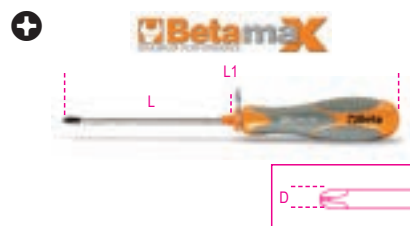

UNI/ISO 8764

PHxDxL	L1	€	1	012924006
0x3x100	196	16,40	1	012924006
1x4,5x120	229	18,10	1	012924012
2x6x150	270	21,80	1	012924021
3x8x150	282	25,00	1	012924024

## 1294HS

chaves para parafusos de perfil de fenda sem cabeça H-SAFE

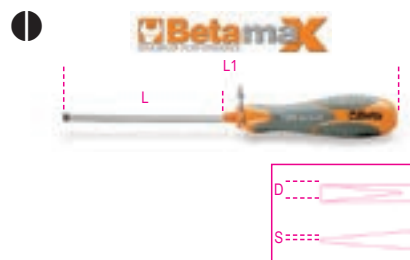

SxDxL	L1	€	1	012944003
0,5x2,5x60	156	15,10	1	012944003
0,6x3x75	171	15,30	1	012944006
0,8x4x100	196	16,90	1	012944012
1x5x125	234	19,70	1	012944018

## 1299HS

chaves para parafusos de perfil Pozidriv® - Supadriv® H-SAFE



UNI/ISO 8764

PZ	L	L1	€	1	012994000
0	60	156	17,10	1	012994000
1	80	189	19,00	1	012994003
2	100	220	23,70	1	012994006
3	150	282	30,00	1	012994009

## 1370T-HS

martelos para mecânica cabo em fibra H-SAFE



g	A	L	L1	€	1	013704630
300	23	300	105	33,00	1	013704630
500	27	320	118	35,00	1	013704650
1000	36	360	135	44,00	1	013704700

## 1370FT-HS

martelos para mecânicos, cabos em fibra H-SAFE



A	L	L1	B	€	1	013704528
28	280	86	22	45,00	1	013704528
30	280	92	24	45,50	1	013704530
36	300	104	29	53,50	1	013704536

## 1390HS

martelos com batentes plásticos intermutáveis, cabo em madeira H-SAFE



UNI 7784

D	L	L1	€	1	013904035
35	310	95	41,50	1	013904035
45	320	107	58,00	1	013904045

### 1392HS

martelos anti-recuo com batentes intermutáveis, cabo em aço H-SAFE



D mm	L mm	L1 mm	€	📦	📄
35	305	115	59,00	1	013924035
40	310	125	65,50	1	013924040
50	325	135	77,50	1	013924050
60	385	155	113,00	1	013924060

### 1602A-HS

alicate para cravar terminais isolados modelo standard H-SAFE



mm <sup>2</sup>	L mm	A mm	B mm	€	📦	📄
0÷6	220	42	4	65,50	1	016024005

### 1682HS

régua graduada flexível em aço inoxidável H-SAFE

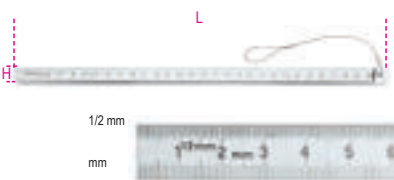

L mm	H mm	± mm	€	📦	📄
200	13	0,5	14,20	1	016824020
300	13	0,5	15,90	1	016824030

### 1692HS

fitas métricas, caixa em ABS anti-choque, fitas em aço, classe de precisão II H-SAFE



L m	S mm	€	📦	📄
3	16	19,10	1	016924053
5	19	22,90	1	016924055

### 1708HS/20

apalpa-folgas H-SAFE



S mm	S mm	L mm	€	📦	📄
0,05÷1,0	0,002÷0,040	105	21,30	1	017084020

### 1727HS

serrote, série pesada H-SAFE



L mm	L1 mm	€	📦	📄
515	300	29,00	1	017274001

### 1743HS

alicate para abraçadeiras em Nylon H-SAFE

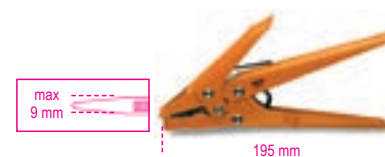

L mm	A mm	B mm	€	📦	📄
195	85	17	62,50	1	017434001

### 1750HS

pistola de massa H-SAFE



1 g, 550 bar Max

cc	L mm	€	📦	📄
500	380	51,50	1	017504500

### 1760BHS

multímetro digital H-SAFE



#### ESPECIFICAÇÕES

Voltagem DC: 200 mV-2/20/200/1000V  
 Voltagem AC: 2-20/200/700V  
 Corrente DC: 2/20/200 mA-20 A  
 Corrente AC: 2/200 mA- 20 A  
 Resistência: 200Ω - 2/20/200 kΩ - 2/20 MΩ  
 Capacidade: 2/20/200 nF - 2/200 μF  
 Temperatura: -20° + 1000°C/ -4 °F ~ +2000°F  
 Frequência: 20kHz  
 Potência de alimentação: Pilha 1 9V (incluída)

1760BHS	€	📦	📄
	192,00	1	017604012

### 1772H-HS

x-acto de lâmina retráctil, de segurança, lâmina de substituição H-SAFE



L mm	A mm	€	U	Art. No.
170	18	25,50	1	017724029

### 1778SOS-HS

navalha manutenção automóvel com quebra-janelase cortante para cintos de segurança fornecida em bolsa H-SAFE



L mm	A mm	L1 mm	€	U	Art. No.
205	25	85	41,50	1	017784080

### 8871

Cinto de segurança com fivela metálica de fecho duplo



L cm	€	U	Art. No.
min-max			
70	117,00	1	088710070
100	127,00	1	088710100

### 8872A

Passador fixo

• Para cinto 8871



8872A 50	€	U	Art. No.
	20,80	1	088720050

### 8872AS

Passador com abertura auto-aderente

• Para cinto 8871



8872AS 25	€	U	Art. No.
	19,10	1	088720525

### 8873

Saco porta-ferramentas com auto-aperto e fecho de correr

• Para cinto 8871



8873	€	U	Art. No.
	100,50	1	088730230

### 8877

Elemento de conexão com amortecimento

• MAX 2.7 kg

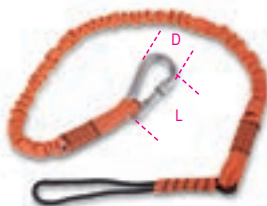

8877 80	L cm	DxL mm	€	U	Art. No.
	min-max				
	70-110	40x80	25,00	1	088770080

### 8877M

Elemento de conexão com amortecimento

• Com junta antitorção

• MAX 2.7 kg



8877M 20-140	L cm	DxL mm	€	U	Art. No.
	min-max				
	20-140	30x60	46,50	1	088770510

### 8879

Faixa para pulso auto-aderente

• MAX 2.7 kg



8879	D mm	€	U	Art. No.
	30	29,50	1	088790025

### 8880

Amarração de conexão rígida

• Com junta antitorção



8880	L Cm	D mm	€	U	Art. No.
	30	10	22,90	1	088800030

### 8883

Saco porta-ferramentas

• Em nylon 840 anti-abrasão• MAX 20 kg• Mosquetão para bloquear o fecho de correr no fim de curso• 6 amarrações de retenção ferramenta• Com bolso interno



8883	DxH cm	€	U	Art. No.
	30x40	240,00	1	088830030



# FERRAMENTAS EM AÇO INOX



INOX + NO INOX = FERRUGEM



INOX + INOX = SEM FERRUGEM

AS FERRAMENTAS BETA INOX PODEM SER ESTERILIZADAS EM AUTOCLAVE A 121 °C

As Ferramentas BETA INOX podem ser utilizadas em ambientes críticos - ou seja, áreas onde não é permitido um nível mínimo de contaminação.

Alguns exemplos incluem:

- Aplicações nucleares
- Indústria farmacêutica - classe C
- Aplicações em plataformas off-shore
- Laboratórios biotecnológicos e biomédicos
- Indústria alimentar.

As ferramentas Beta Inox evitam a formação indevida de ferrugem.

Ao utilizar outras ferramentas em parafusos, porcas ou superfícies em aço inox, são libertadas algumas partículas que desencadeiam a corrosão. Muitas vezes isso resulta em problemas estéticos e, por vezes, também em problemas estruturais.

Alguns exemplos de aplicações:

- Estaleiros navais
- Construção
- Sistemas solares
- Indústria automóvel.

## CARACTERÍSTICAS

A selecção dos melhores materiais<sup>1</sup> e busca contínua do melhor tratamento térmico conferem às ferramentas Beta Inox características mecânicas que excedem largamente as normas em vigor, sendo comparáveis à restante gama de Ferramentas Beta.

Também apresentam características ergonómicas e de design idênticas à linha Beta tradicional, amplamente reconhecida e apreciada pelos utilizadores profissionais há mais de 75 anos. O aço inox é 100% reciclável, o que também representa uma grande vantagem em termos ambientais.

<sup>1</sup> A Beta Utensili utiliza aço inox magnético AISI 420

## 34INOX

Escopros planos, em aço inox



L mm	A mm	Ø mm	€	🔧	📦
160	18	18	36,00	1	000340318
200	20	20	53,50	1	000340320

## 39INOX

Cunhas, em aço inox



L mm	A mm	S mm	€	🔧	📦
100	50	10	24,00	1	000390310
150	50	13	45,00	1	000390315
200	40	40	136,00	1	000390320

## 42INOX

chave boca/luneta em aço inox



🔧 mm	L mm	€	🔧	📦
6x6	95	12,60	2	000420306
7x7	105	12,90	2	000420307
8x8	116	13,10	2	000420308
9x9	127	14,20	2	000420309
10x10	137	15,10	2	000420310
11x11	148	15,90	2	000420311
12x12	158	16,60	2	000420312
13x13	169	16,80	2	000420313
14x14	180	17,40	2	000420314
15x15	190	18,00	2	000420315
16x16	201	18,60	2	000420316
17x17	212	20,80	2	000420317
18x18	222	22,40	2	000420318
19x19	233	24,00	2	000420319
21x21	254	30,00	1	000420321
22x22	264	31,50	1	000420322
24x24	285	34,00	1	000420324



42INOX/S11	€	🔧	📦
6-8-10-11-12-13-14-15-16-17-19 mm	189,00	1	000420391





<b>42INOX/SC9</b>	€ 165,00	1	000420387
8-10-11-12-13-14-15-17-19 mm			
<b>42/SCV9I</b>	€ 8,95	1	000420103

### 42INOX-AS

chaves combinadas,  
boca/luneta,  
em aço inoxidável



"	L mm	€	U	Art.
1/4x1/4	95	15,10	1	000420356
5/16x5/16	116	15,30	1	000420358
3/8x3/8	137	18,60	1	000420360
7/16x7/16	148	19,90	1	000420361
1/2x1/2	169	20,20	1	000420363
9/16x9/16	180	21,80	1	000420364
5/8x5/8	201	22,90	1	000420366
11/16x11/16	212	26,00	1	000420367
3/4x3/4	233	29,50	1	000420369
13/16x13/16	254	34,50	1	000420371
7/8x7/8	264	35,50	1	000420372
15/16x15/16	285	40,50	1	000420373



<b>42INOX-AS/S9</b>	€ 190,00	1	000420396
1/4-5/16-3/8-7/16-1/2 9/16-5/8-11/16-3/4			

### 96BPINOX

chave sextavada cabeça de bola,  
em aço inox



mm	L mm	L1 mm	g	€	U	Art.
2	91	22	4	4,40	4	000961441
2,5	91	22	6	4,40	4	000961442
3	101	24	11	4,70	4	000961443
4	112	29	19	5,15	4	000961444
5	131	33	32	6,25	4	000961445
6	154	36	51	6,90	4	000961446
7	164	40	65	9,05	2	000961447
8	175	44	116	10,90	2	000961448
10	197	51	189	13,70	2	000961450



<b>96BPINOX/B6</b>	€ 44,00	1	000961455
2,5-3-4-5-6-8 mm			
<b>96BPINOX/B9</b>	€ 71,00	1	000961456
2-2,5-3-4-5- 6-7-8-10 mm			
<b>96BPINOX/BV</b>	€ 5,45	1	000961459

### 96BPINOX-AS

chaves de bola sextavadas,  
em aço inoxidável



"	L mm	L1 mm	g	€	U	Art.
5/64	91	22	5,5	5,70	4	000961989
3/32	91	22	5,3	5,70	4	000961990
7/64	101	24	10,5	6,15	4	000961991
1/8	101	24	10,7	6,15	4	000961992
9/64	112	29	18,7	6,65	4	000961993
5/32	112	29	18,7	6,65	4	000961994
3/16	131	33	31,5	8,95	2	000961995
7/32	154	36	50,0	9,30	2	000961996
1/4	164	40	70,0	9,85	2	000961997
5/16	175	44	115,0	12,00	2	000961998
3/8	197	51	186,5	14,50	2	000961999



<b>96BPINOX-AS/B8</b>	€ 70,00	1	000962000
5/64-3/32-1/8-5/32- 3/16-7/32-1/4-5/16			
<b>96BPINOX/BV</b>	€ 5,45	1	000961459

### 96TINOX

chave sextavada,  
com punho de binário elevado,  
em aço inox

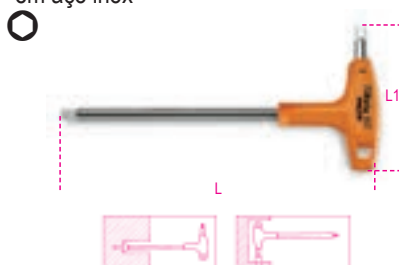

mm	L mm	L1 mm	€	U	Art.
2,5	153	55	10,60	2	000961935
3	153	55	11,20	2	000961936
4	179	70	12,30	2	000961938
5	200	84	13,50	2	000961940
6	221	95	14,80	2	000961941
7	236	106	16,90	2	000961942
8	255	117	20,20	2	000961943
10	285	132	26,00	2	000961944



<b>96TINOX/S5</b>	€ 62,50	1	000961952
2,5-3-4-5-6 mm			
<b>96TINOX/S8</b>	€ 126,00	1	000961954
2,5-3-4-5- 6-7-8-10 mm			

### 96TINOX-AS

chaves sextavadas,  
com punhos de elevado aperto,  
em aço inoxidável

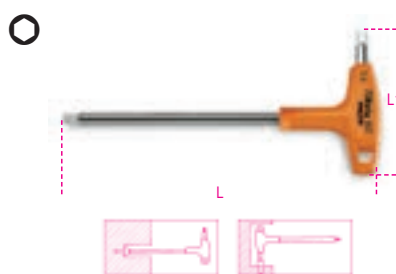

"	L mm	L1 mm	Ø mm	€	U	Art.
3/32	153	55	3	11,70	2	000961861
7/64	153	55	4	12,00	2	000961862
1/8	179	70	4	13,30	2	000961863
9/64	179	70	5	13,70	2	000961864
5/32	200	84	6	14,40	2	000961865
3/16	200	84	6	15,50	2	000961866
7/32	221	103	7	18,00	2	000961867
1/4	236	106	8	18,60	2	000961868
5/16	255	117	10	22,90	2	000961869
3/8	285	132	12	25,00	2	000961870



<b>96TINOX-AS/S7</b>	€ 115,00	1	000961877
3/32-1/8-5/32-3/16- 7/32-1/4-5/16			

### 111INOX

Chaves ajustáveis, em aço inox



L mm	L' mm	A max mm	A1 mm	€	U	Art.
150	6	18	45	74,50	1	001110315
200	8	24	58	98,50	1	001110320
250	10	30	70	123,00	1	001110325

## 920INOX-A

Chaves de caixa sextavadas, em aço inox

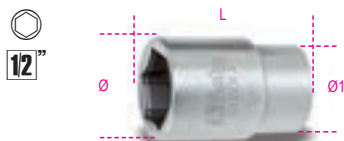

mm	Ø mm	A mm	L mm	€	🔧	📦
8	15	10	40	28,00	2	009203008
9	16	10	40	29,50	2	009203009
10	17	10	40	31,50	2	009203010
11	18	11	40	33,00	2	009203011
12	19	11	40	35,00	2	009203012
13	20	11	40	37,50	2	009203013
14	21	11	40	39,00	2	009203014
15	23	11	40	41,00	2	009203015
16	24	11	40	43,00	2	009203016
17	25	11	40	44,00	2	009203017
18	26	13	42	46,00	2	009203018
19	28	13	42	48,00	2	009203019
20	29	13	42	51,00	1	009203020
21	30	13	43	51,50	1	009203021
22	31	15	43	52,00	1	009203022
24	34	15	43	60,50	1	009203024
27	38	18	46	74,50	1	009203027
30	42	20	46	88,00	1	009203030
32	44	20	46	98,50	1	009203032

## 920/55INOX

Roquete reversível quadra 1/2", 72 dentes, em aço inox



L mm	Ø mm	A mm	€	🔧	📦
264	40	43	202,00	1	009203882

## 920/R55INOX



920/R55INOX	€	🔧	📦
	73,50	1	009203879

## 1048INOX

Alicate ajustável, de charneira fechada, em aço inox

• Modelo de 7 posições

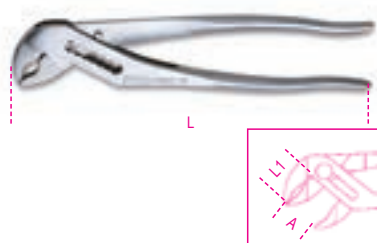

L mm	A max mm	L1 mm	€	🔧	📦
250	33	33	130,00	1	010480325

## 1153INOX

Alicates ajustáveis com duas posições, aço inox



L mm	L1 mm	€	🔧	📦
150	26	93,00	1	011530315

## 1290INOX

chaves para parafusos de perfil de fenda em aço inox

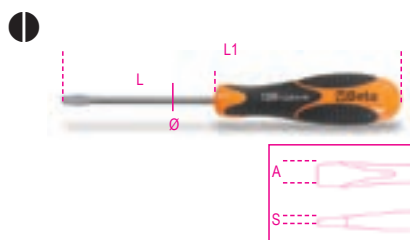

SxAxL mm	L1 mm	Ø mm	€	🔧	📦
0,4x2,5x50	146	2.5	7,65	4	012900403
0,5x3x75	171	3.0	8,00	4	012900409
0,8x4x100	196	4.0	8,55	4	012900430
1,0x5,5x150	259	5.0	10,70	4	012900442
1,2x6,5x150	270	6.0	12,00	4	012900451

## 1292INOX

chaves para parafusos de perfil Phillips®, em aço inox

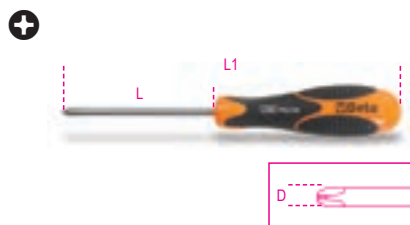

PHxDxL mm	L1 mm	€	🔧	📦
0x3x60	156	7,35	4	012920403
1x4,5x80	189	8,85	4	012920409
2x6x100	220	10,70	4	012920418

## 1293INOX/D8

Jogo de 8 chaves de fendas em aço inox



1293INOX/D8	€	🔧	📦
	74,00	1	012930408
1290INOX			0,4x2,5x50-0,5x3x75-0,8x4x100-1,0x5,5x150-1,2x6,5x150 mm
1292INOX			PH0x60-PH1x80-PH2x100 mm

## 1370INOX

Martelo para mecânico tipo alemão, em aço inox



g	A mm	L mm	L1 mm	€	🔧	📦
500	25	240	101	76,50	1	013700375

## C20TSS

Caixa de ferramentas extensível com 5 divisões, em aço inox AISI 304



C20TSS	€	🔧	📦
	257,00	1	021203001

📏: 450x200x210 mm - 🏠: 4kg



## C04TSS-7

carro com sete gavetas, totalmente em aço inoxidável

Principais características:

- Sete gavetas (570 x 410 mm) com calhas assentes em rolamentos de esferas;
- 6 gavetas, 83 mm altura;
- 1 gaveta, 170 mm altura;
- 4 rodízios Ø 125 mm
- 2 fixos e 2 giratórios (dois com travão);
- Fechadura frontal centralizada;
- Estrutura totalmente fabricada em aço inoxidável
- Roletes, suportes, esferas, interiores de gavetas e calhas em aço inoxidável
- Pegas das gavetas em alumínio

63 kg

Beta  
INOX  
STAINLESS STEEL

700  
kg

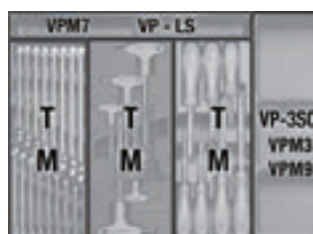

h	max
83 mm	25 kg
170 mm	30 kg

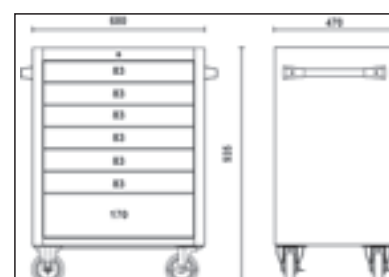
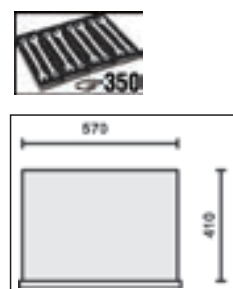

C04TSS/7

€ 2.275,00 1 024003077

# FERRAMENTAS ANTI-FAÍSCA

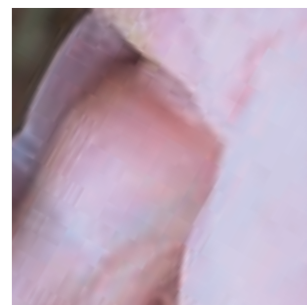
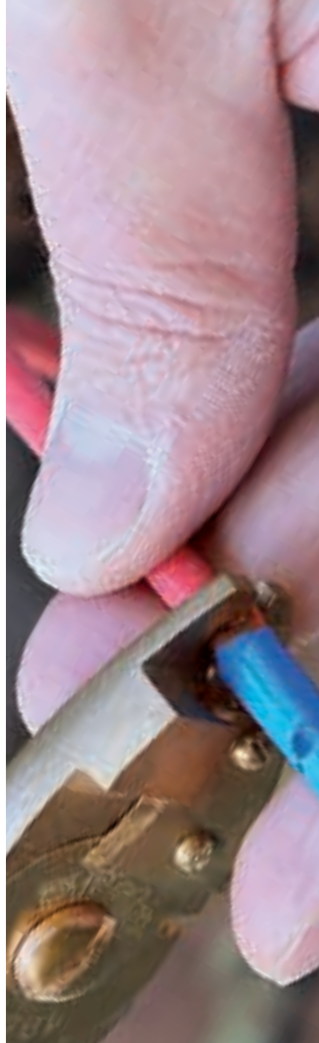

As ferramentas antifaíscentes da Beta são certificadas pelo Federal Institute for Materials Research and Testing, BAM, sob diretiva Europeia 99/92/EC



## COBRE-BERÍLIO CU-BE

As ferramentas anti-faísca da **Beta** foram especialmente concebidas para operar com segurança em atmosferas potencialmente explosivas, na presença de líquidos ou gases inflamáveis, ou para aplicações que requerem ferramentas não magnéticas e resistentes à corrosão.

### CLASSIFICAÇÃO DE ATMOSFERAS POTENCIALMENTE EXPLOSIVAS

ATEX	MÉDIO-BAIXO	EXTREMAMENTE BAIXO
<b>GASES</b>	<b>ZONA 1</b> Área onde é provável, em condições normais de funcionamento, a formação ocasional de uma atmosfera explosiva constituída por uma mistura de ar com substâncias inflamáveis, sob a forma de gás, vapor ou névoa.	<b>ZONA 2</b> Área onde não é provável, em condições normais de funcionamento, a formação de uma atmosfera explosiva constituída por uma mistura de ar com substâncias inflamáveis, sob a forma de gás, vapor ou névoa, ou onde essa formação, caso se verifique, seja de curta duração.
<b>POEIRAS</b>	<b>ZONA 21</b> Área onde é provável, em condições normais de funcionamento, a formação ocasional de uma atmosfera explosiva sob a forma de uma nuvem de poeira combustível.	<b>ZONA 22</b> Área onde não é provável, em condições normais de funcionamento, a formação de uma atmosfera explosiva sob a forma de uma nuvem de poeira combustível, ou onde essa formação, caso se verifique, seja de curta duração.



## AVISO! Risco de explosão em ambientes expostos a ACETILENO

As características mecânicas das ferramentas anti-faísca diferem das características das ferramentas em aço normais. As ferramentas anti-faísca devem ser utilizadas com extrema precaução, evitando sobrecargas.

### 30BA

punção anti-faísca



Ø mm	L mm	S mm	€	U	IT
5	150	15	54,00	1	000300806
8	150	17	66,50	1	000300808
10	150	19	83,00	1	000300810

### 31BA

punção anti-faísca



Ø mm	L mm	€	U	IT
3	110	24,00	1	000310853
4	110	50,50	1	000310854
6	115	76,50	1	000310856
8	120	87,50	1	000310858

### 32BA

punções anti-faísca



Ø mm	L mm	€	U	IT
14	150	76,50	1	000320811

### 34BA

escopro plano anti-faísca



L mm	A mm	€	U	IT
200	22	102,50	1	000340801
250	24	171,00	1	000340803
300	25	223,00	1	000340802

### 39BA

cunha anti-faísca



L mm	A mm	€	U	IT
150	40	44,00	1	000390801
230	40	147,00	1	000390802
250	40	235,00	1	000390803

### 42BA

chave boca-luneta bi-sextavada anti-faísca



Ø mm	L mm	€	U	IT
6x6	105	48,00	1	000420806
7x7	105	53,00	1	000420807
8x8	120	59,00	1	000420808
9x9	120	68,00	1	000420809
10x10	135	74,00	1	000420810
11x11	135	77,50	1	000420811
12x12	150	84,50	1	000420812
13x13	150	87,50	1	000420813
14x14	175	92,00	1	000420814
15x15	175	96,00	1	000420815
16x16	195	100,50	1	000420816
17x17	200	105,00	1	000420817
18x18	215	118,00	1	000420818
19x19	220	119,00	1	000420819
20x20	230	126,00	1	000420820
21x21	240	133,00	1	000420821
22x22	250	141,00	1	000420822
24x24	268	163,00	1	000420824
26x26	290	201,00	1	000420826
27x27	290	221,00	1	000420827
28x28	290	257,00	1	000420828
30x30	313	262,00	1	000420830
32x32	333	292,00	1	000420832
34x34	360	317,00	1	000420834
35x35	360	356,00	1	000420835
36x36	355	371,00	1	000420836
38x38	430	395,00	1	000420838
41x41	430	464,00	1	000420841
46x46	480	542,00	1	000420846
50x50	520	576,00	1	000420850
55x55	560	633,00	1	000420855
60x60	580	676,00	1	000420860
*65x65	595	780,00	1	000420865
*70x70	630	869,00	1	000420870

### 42BA-AS

chave boca-luneta bi-sextavada anti-faísca



Ø mm	L mm	€	U	IT
9/32x9/32	120	51,50	1	000420946
5/16x5/16	120	51,50	1	000420947
11/32x11/32	135	65,50	1	000420948
3/8x3/8	128	69,00	1	000420950
7/16x7/16	135	78,50	1	000420951
15/32x15/32	140	86,50	1	000420949
1/2x1/2	140	89,50	1	000420953
9/16x9/16	163	96,00	1	000420954
5/8x5/8	177	118,00	1	000420956
11/16x11/16	195	126,00	1	000420957
3/4x3/4	215	129,00	1	000420959
13/16x13/16	230	151,00	1	000420961
7/8x7/8	235	156,00	1	000420962
15/16x15/16	256	174,00	1	000420964
1x1	266	186,00	1	000420965
1.1/16x1.1/16	283	211,00	1	000420967
1.1/8x1.1/8	297	278,00	1	000420969
1.3/16x1.3/16	308	300,00	1	000420970
1.1/4x1.1/4	324	355,00	1	000420973

### 55BA

chave de bocas anti-faísca



Ø mm	L mm	€	U	IT
6x7	90	33,00	1	000550801
8x9	100	35,00	1	000550802
8x10	100	36,00	1	000550795
9x11	110	39,00	1	000550797
10x11	120	41,50	1	000550803
12x13	130	51,50	1	000550804
13x14	133	62,50	1	000550799
14x15	145	63,50	1	000550805
14x17	150	66,50	1	000550806
16x17	165	67,50	1	000550807
18x19	170	91,50	1	000550809
20x22	185	105,50	1	000550811
21x23	210	113,00	1	000550813
22x24	210	136,00	1	000550815
24x26	230	160,00	1	000550817
24x27	230	171,00	1	000550818
25x28	230	183,00	1	000550819
27x29	246	215,00	1	000550820
30x32	265	250,00	1	000550822
36x38	320	320,00	1	000550826
36x41	335	348,00	1	000550828
41x46	355	432,00	1	000550829
*46x50	370	491,00	1	000550830
*50x55	385	524,00	1	000550831
*55x60	415	652,00	1	000550832

### 55BA-AS

chave de bocas anti-faísca



Ø mm	L mm	€	U	IT
3/8x7/16	110	43,50	1	000550853
1/2x9/16	130	50,50	1	000550854
5/8x11/16	160	74,50	1	000550857
3/4x13/16	180	92,00	1	000550859
7/8x15/16	210	128,00	1	000550865
1x1.1/16	230	174,00	1	000550868
1.1/8x1.3/16	245	227,00	1	000550870
1.1/4x1.5/16	255	268,00	1	000550872

### 58BA

chaves de bocas de pancada anti-faísca



Ø mm	L mm	€	U	IT
17	125	87,50	1	000580817
19	125	90,50	1	000580819
22	135	92,00	1	000580822
24	150	102,00	1	000580824
27	165	126,00	1	000580827
30	180	157,00	1	000580830
32	190	184,00	1	000580832
36	210	217,00	1	000580836
38	220	237,00	1	000580838
41	230	270,00	1	000580841
46	240	321,00	1	000580846
50	255	361,00	1	000580850
*55	305	450,00	1	000580855
*60	315	530,00	1	000580860
*65	335	611,00	1	000580865
*70	370	740,00	1	000580870
*75	375	864,00	1	000580875
*80	400	1.036,00	1	000580880



## 78BA

chave de luneta de pancada bi-sextavada anti-faísca



Ø mm	L mm	€	Hand	Weight
17	145	92,00	1	000780817
19	145	99,50	1	000780819
22	165	101,50	1	000780822
24	140	121,00	1	000780824
27	155	143,00	1	000780827
30	165	167,00	1	000780830
32	180	179,00	1	000780832
34	192	198,00	1	000780834
36	208	217,00	1	000780836
38	215	254,00	1	000780838
41	225	299,00	1	000780841
46	245	338,00	1	000780846
50	250	387,00	1	000780850
55	265	454,00	1	000780855
60	275	491,00	1	000780860
65	295	529,00	1	000780865
70	310	592,00	1	000780870
75	325	668,00	1	000780875
80	340	713,00	1	000780880

## 78BA-AS

chave de luneta de pancada bi-sextavada anti-faísca



Ø mm	L mm	€	Hand	Weight
11/16	145	93,00	1	000780908
3/4	145	95,00	1	000780909
7/8	155	107,00	1	000780935
15/16	165	117,00	1	000780936
1	175	139,00	1	000780938
1.1/8	180	164,00	1	000780940
1.1/4	177	186,00	1	000780910
1.7/16	208	246,00	1	000780912
1.5/8	225	317,00	1	000780914
1.13/16	243	360,00	1	000780916
2	254	420,00	1	000780918
2.3/16	264	491,00	1	000780920
2.3/8	275	535,00	1	000780922
*2.9/16	286	556,00	1	000780924
*2.15/16	311	665,00	1	000780926
*3.1/8	325	774,00	1	000780928
*3.1/2	355	992,00	1	000780930

## 89BA

chave de luneta simples anti-faísca



Ø mm	L mm	€	Hand	Weight
10	200	105,00	1	000890810
11	210	107,00	1	000890811
12	220	111,00	1	000890812
13	230	114,00	1	000890813
14	240	116,00	1	000890814
16	260	123,00	1	000890816
17	270	129,00	1	000890817
18	280	137,00	1	000890818
19	300	144,00	1	000890819
20	310	175,00	1	000890820
22	330	184,00	1	000890822
24	350	195,00	1	000890824
27	370	240,00	1	000890827
30	400	262,00	1	000890830
32	420	284,00	1	000890832

## 90BA

chave de luneta anti-faísca



Ø mm	L mm	€	Hand	Weight
6x7	122	33,50	1	000900801
8x9	128	43,00	1	000900802
10x11	155	49,50	1	000900803
12x13	175	57,50	1	000900806
14x15	200	68,00	1	000900808
14x17	220	70,00	1	000900809
16x17	230	81,00	1	000900811
16x18	235	81,00	1	000900812
18x19	265	94,00	1	000900815
20x22	295	111,00	1	000900818
21x23	298	118,00	1	000900820
22x24	315	141,00	1	000900821
24x26	333	178,00	1	000900822
24x27	340	178,00	1	000900823
30x32	395	262,00	1	000900824
34x36	410	380,00	1	000900826
*36x41	450	513,00	1	000900828
*41x46	470	622,00	1	000900829
*46x50	490	689,00	1	000900830

## 91BA

chave de luneta anti-faísca para trabalhos pesados



Ø mm	Ø mm	€	Hand	Weight
24	38	216,00	1	000910824
27	42	265,00	1	000910827
30	48	306,00	1	000910830
32	49	338,00	1	000910832
36	54	371,00	1	000910836
41	62	415,00	1	000910841
*46	69	540,00	1	000910846
*50	75	589,00	1	000910850
*55	82	761,00	1	000910855

## 92BA

tubo anti-faísca para ref. 91BA



	L mm	91BA mm	Ø mm	€	Hand	Weight
92BA/1	460	24÷30	25	257,00	1	000920810
92BA/2	610	32÷41	28	327,00	1	000920820
*92BA/3	760	46÷55	32	447,00	1	000920830

## 93BA

chave de lunetas para parafusos para andaimes, anti-faísca



Ø mm	L mm	€	Hand	Weight
21x22	345	545,00	1	000930821

## 95BA

chave de lunetas direitas, anti-faísca



Ø mm	L mm	€	Hand	Weight
7x9	115	33,00	1	000950801
8x10	115	36,00	1	000950802
10x11	140	40,50	1	000950804
10x12	140	47,50	1	000950805
12x14	145	54,00	1	000950806
14x17	165	65,00	1	000950807
*16x18	170	85,50	1	000950809
*17x19	185	73,50	1	000950808
*18x19	185	93,00	1	000950810
*19x22	200	115,00	1	000950812
*21x23	230	127,00	1	000950815
*24x27	255	161,00	1	000950817
*30x32	295	242,00	1	000950820

## 96BA

chave sextavada anti-faísca

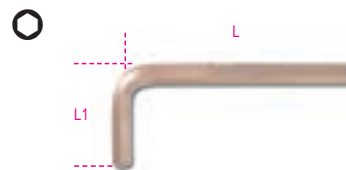

mm	L mm	L1 mm	€	Hand	Weight
1,5	50	17	67,50	1	000960760
2	50	16	68,50	1	000960762
2,5	56	20	74,50	1	000960761
3	63	21	76,00	1	000960763
4	69	25	80,00	1	000960764
5	78	29	82,00	1	000960765
6	88	33	84,00	1	000960766
7	93	34	87,50	1	000960767
8	97	36	93,50	1	000960768
9	104	37	96,50	1	000960769
10	110	39	100,50	1	000960770
12	122	44	124,00	1	000960772

## 96BA/BP

chave sextavada ponta de bola, anti-faísca

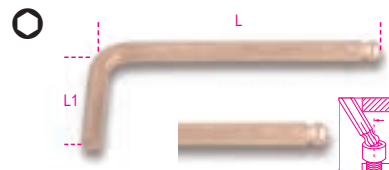

Ø mm	L mm	L1 mm	€	Hand	Weight
1,5	50	16	69,50	1	000961800
2	50	16	70,00	1	000961801
2,5	63	20	77,50	1	000961802
3	60	20	80,00	1	000961803
3,5	70	25	82,00	1	000961799
4	66	25	83,00	1	000961804
5	75	28	85,50	1	000961805
6	84	32	87,50	1	000961806
8	92	36	95,00	1	000961808
10	102	40	102,50	1	000961810
12	113	45	127,00	1	000961812

### 99BA

chave de gancho anti-faísca, para porcas ranhuradas UNI/ISO 2982, 2983



mm	A mm	€	U	PC
32-75	4,0	177,00	1	000990803
50-120	4,5	270,00	1	000990805
115-170	4,5	431,00	1	000990811

### 110BA

chave ajustável anti-faísca



L mm	A max mm	€	U	PC
100	13	128,00	1	001100810
150	18	148,00	1	001100815
200	24	176,00	1	001100820
250	30	210,00	1	001100825
300	36	295,00	1	001100830
375	46	396,00	1	001100837
★450	55	555,00	1	001100845
★600	65	940,00	1	001100860

### 330BA

corta tubos anti-faísca para tubos de gás



330BA/2	Ø max 50 mm	L mm	€	U	PC
	2"	375	690,00	1	003300802

### 330BA/2R

cavilha e canivete de substituição para corta-tubos anti-faísca 330BA para tubos de gás



330BA/2-R	€	U	PC
	68,00	1	003300822

### 363BA

chave para tubos anti-faísca para trabalhos pesados



L mm	Ø max mm	Ø max mm	€	U	PC
150	1/2" gas	20	222,00	1	003630815
200	1" gas	30	224,00	1	003630820
250	1 1/2" gas	49	257,00	1	003630825
300	2" gas	60	322,00	1	003630830
350	2" gas	60	404,00	1	003630835
450	2 1/2" gas	76	616,00	1	003630845
600	3" gas	90	868,00	1	003630860

### 378BA

chave de tubos anti-faísca, modelo sueco, em liga de cobre-berílio



L mm	Ø max "	€	U	PC
430	1" 1/2 gas	682,00	1	003780800
530	2" gas	829,00	1	003780801

### 386BA

chave de corrente para tubos anti-faísca reversível, para trabalhos pesados



L mm	Ø max mm	L1 mm	€	U	PC
600	100	470	1.025,00	1	003860806
900	200	750	1.725,00	1	003860809



### 921BA

chave de caixa bisextavada anti-faísca

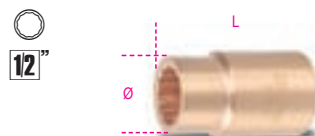

mm	Ø mm	L mm	€	U	PC
8	24,0	40	67,50	1	009210808
9	24,0	40	71,50	1	009210809
10	16,5	40	81,00	1	009210810
11	17,5	40	84,50	1	009210811
12	18,5	40	89,50	1	009210812
13	19,5	40	94,00	1	009210813
14	20,0	40	96,00	1	009210814
15	21,5	40	100,00	1	009210815
16	24,0	40	103,50	1	009210816
17	25,0	40	107,00	1	009210817
18	25,0	40	111,00	1	009210818
19	28,0	42	115,00	1	009210819
20	29,0	42	120,00	1	009210820
21	30,0	43	123,00	1	009210821
22	30,5	43	128,00	1	009210822
24	34,0	43	149,00	1	009210824
25	36,0	43	162,00	1	009210825
26	37,5	43	172,00	1	009210826
27	37,5	45	180,00	1	009210827
28	38,9	46	190,00	1	009210828
30	41,5	46	216,00	1	009210830
32	43,5	46	240,00	1	009210832

### 921BA-AS

Chave de caixa bisextavada anti-faísca

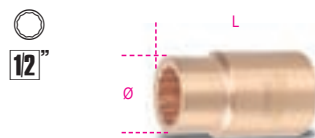

"	Ø mm	L mm	€	U	PC
5/16	24,0	40	73,50	1	009210958
3/8	24,0	40	79,50	1	009210960
7/16	24,0	40	86,50	1	009210961
1/2	24,0	40	93,00	1	009210963
9/16	24,0	40	95,00	1	009210964
5/8	25,0	40	111,00	1	009210966
11/16	25,5	40	119,00	1	009210967
3/4	28,0	42	130,00	1	009210969
13/16	30,0	43	138,00	1	009210971
7/8	31,5	43	150,00	1	009210972
15/16	34,0	43	159,00	1	009210974
1	36,0	43	177,00	1	009210975
1.1/16	38,0	46	191,00	1	009210977
1.1/4	42,0	46	253,00	1	009210982
1.7/16	50,5	50	311,00	1	009210986

### 921BA/21 - 921BA/22

extensão anti-faísca com encabadouro 1/2"



921BA/21	L mm	Ø mm	€	U	PC
	125	30	111,00	1	009210842
921BA/22	250	31	154,00	1	009210844

## 921BA/25

cardan anti-faísca com quadras macho e fêmea de 1/2"



L	Ø	€	🔧	📦
mm	mm			
80	25	1/2	1/2	114,00 1 009210845

## 921BA/42

punho em T anti-faísca encabadouro 1/2"

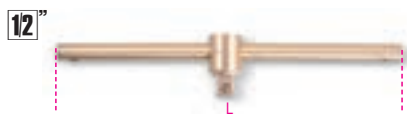

L	€	🔧	📦
mm			
250	186,00	1	009210846

## 921BA/50

roquete anti-faísca encabadouro quadrado 1/2"



L	D	A	€	🔧	📦
mm	mm	mm			
250	45	16,5	218,00	1	009210850

## 921BA/R50

quadra de substituição para roquete anti-faísca

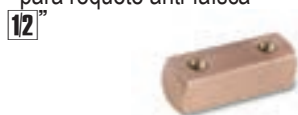

1/2"	€	🔧	📦
64,50	1	009210851	

## 926BA

chave de caixa anti-faísca bi-sextavada

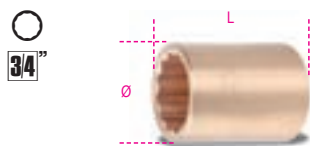

Ø	Ø	L	€	🔧	📦
mm	mm	mm			
24	40	55	163,00	1	009260824
26	40	55	186,00	1	009260826
27	40	55	197,00	1	009260827
28	41	55	228,00	1	009260828
30	43	60	230,00	1	009260830
32	45	60	260,00	1	009260832
34	48	60	280,00	1	009260834
36	50	60	301,00	1	009260836
38	53	60	321,00	1	009260838
41	57	65	353,00	1	009260841
46	63	65	416,00	1	009260846
50	68	70	460,00	1	009260850

## 926BA/22

extensão anti-faísca com encabadouro 3/4"



L	Ø	€	🔧	📦
mm	mm			
926BA/22	200	38	232,00	1 009260872

## 926BA/42

punho em T anti-faísca encabadouro 3/4"



L	€	🔧	📦
mm			
400	336,00	1	009260876

## 926BA/50

roquete reversível anti-faísca encabadouro 3/4"



L	D	A	€	🔧	📦
mm	mm	mm			
300	61	22	337,00	1	009260880

## 926BA/R50

quadra de substituição para roquete anti-faísca



3/4"	€	🔧	📦
111,00	1	009260881	

## 937BA

chave de cachimbo sextavada, anti-faísca



Ø	L	A	€	🔧	📦
mm	mm	mm			
13	240	45	86,50	1	009370813
17	260	51	124,00	1	009370817
19	270	55	130,00	1	009370819
22	278	59	171,00	1	009370822
24	286	63	183,00	1	009370824
27	294	69	195,00	1	009370827
30	302	75	213,00	1	009370830
32	310	81	234,00	1	009370832
★36	330	85	275,00	1	009370836
★41	350	90	333,00	1	009370841

## 961BA

Alavanca anti-faísca



L	A	€	🔧	📦
mm	mm			
250	39	124,00	1	009610802
350	55	186,00	1	009610806

## 963BA

alavancas anti-faísca com uma extremidade aguçada e outra plana



L	A	€	🔧	📦
mm	mm			
500	24	345,00	1	009630801
★800	24	545,00	1	009630803
★1000	30	1.150,00	1	009630805

## 964BA

chave para tampões anti-faísca



L	€	🔧	📦
mm			
385	330,00	1	009640801

## 964BA/L

chave universal para tampões; anti-faísca

Para abrir tampões em metal

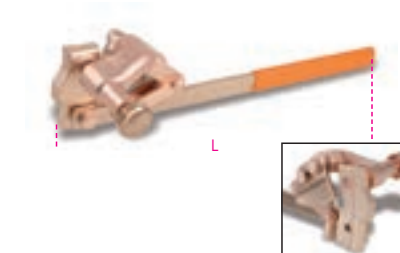

★964BA/L	L	€	🔧	📦
	mm			
	510	1.690,00	1	009640821

## 965BA

chave para válvulas de segurança, anti-faísca



A	A1	L	€	🔧	📦
mm	mm	mm			
30	44	200	148,00	1	009650830
32	50	300	202,00	1	009650832
35	47	250	163,00	1	009650835
40	50	300	190,00	1	009650840
45	58	350	247,00	1	009650845
48	62	375	259,00	1	009650848
50	67	400	282,00	1	009650850
55	73	450	335,00	1	009650855
60	79	500	360,00	1	009650860
★65	82	550	410,00	1	009650865
★70	85	600	452,00	1	009650870



## 966BA

chave de válvulas de segurança anti-faísca

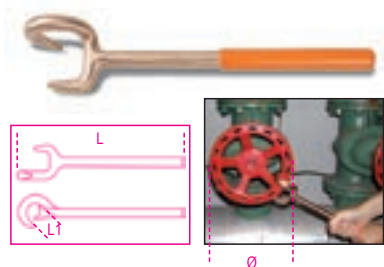

L mm	L1 mm	Ø min+max mm	€	1	009660801
350	40	50÷150	321,00	1	009660801

## 966BA/V

chaves válvula de segurança anti-faísca

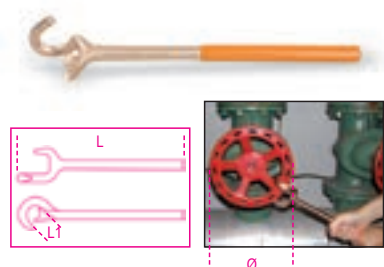

L mm	L1 mm	Ø min+max mm	€	1	009660812
370	36	125÷250	317,00	1	009660812
430	48	250÷400	460,00	1	009660814

## 1032BA

alicate anti-faísca com circlip interno, plano, pegas revestimento em PVC



L mm	Ø mm	€	1	010320820
200	40÷100	212,00	1	010320820

## 1036BA

alicate anti-faísca com circlip externo, plano, pegas revestimento em PVC



L mm	Ø mm	€	1	010360820
200	40÷100	212,00	1	010360820

## 1046BA

alicate anti-faísca

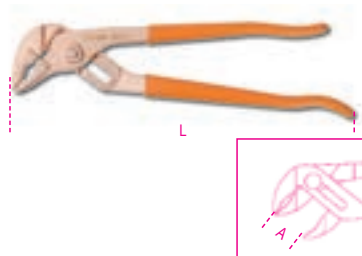

L mm	A max mm	€	1	010460801
250	32	264,00	1	010460801
300	52	348,00	1	010460803

## 1052BA

Alicate de pressão, maxilas côncavas, anti-faísca

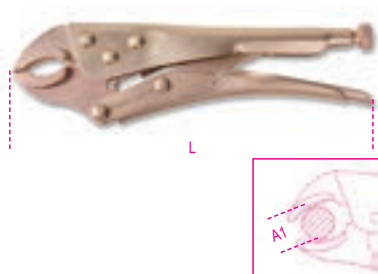

L mm	A1 max mm	€	1	010520824
225	40,0	262,00	1	010520824

## 1082BA

alicate de corte diagonal anti-faísca



L mm	L1 mm	€	1	010820801
160	22	190,00	1	010820801

## 1137BA

alicate de cravagem



L mm	L1 mm	€	1	011370801
185	30	354,00	1	011370801

## 1137BA/RC

mordente sobresselente para ref. 1137BA



1137BA/RC	€	1	011370851
	69,00	1	011370851

## 1150BA

alicate universal anti-faísca

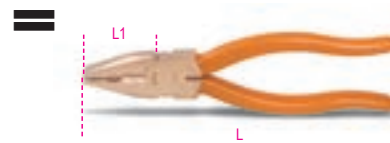

L mm	L1 mm	€	1	011500820
200	40	224,00	1	011500820

## 1162BA

alicate de pontas planas extra-longas anti-faísca



L mm	L1 mm	€	1	011620815
150	54	177,00	1	011620815

## 1166BA

alicate de pontas semi-redondas extra-longas anti-faísca



L mm	L1 mm	€	1	011660815
150	54	177,00	1	011660815

## 1270BA

chave de fendas anti-faísca



AxL mm	L1 mm	€	1	012700803
3x75	178	33,00	1	012700803
4x100	209	41,00	1	012700804
5x150	250	53,00	1	012700805
6x150	270	57,50	1	012700806
10x250	382	87,00	1	012700810
8x200	312	63,50	1	012700808

## 1272BA

chave de fendas anti-faísca para parafusos Phillips®



PHxDxL mm	L1 mm	€	🔧	📦
1x5x100	209	45,00	1	012720801
2x6x150	270	58,00	1	012720802
3x8x200	332	69,00	1	012720803

## 1370BA

martelo para mecânico anti-faísca, cabo em madeira



g	A mm	L mm	L1 mm	€	🔧	📦
500	30	310	108	118,00	1	013700805
1000	35	340	137	210,00	1	013700810

## 1370BA/MR

cabo de substituição para ref. 1370BA

	€	🔧	📦
1370BA/MR 500 1370BA/500	20,80	1	013700865
1370BA/MR 1000 1370BA/1000	25,50	1	013700870

## 1375BA/PL

martelo de orelhas anti-faísca, cabo em fibra



g	L mm	L1 mm	Ø mm	€	🔧	📦
680	321	125	30	153,00	1	013750800

## 1377BA

martelo de bola anti-faísca, cabeça redonda, para trabalhos em cobre e latão



g	L1 mm	L mm	€	🔧	📦
340	90	280	76,50	1	013770834

## 1377BA/PL

martelo de bola anti-faísca, cabeça redonda, para trabalhos em cobre e latão



g	L1 mm	L mm	€	🔧	📦
340	90	280	76,50	1	013770884

## 1379BA

martelo picador anti-faísca, cabo em madeira



g	L1 mm	L mm	€	🔧	📦
500	142	315	150,00	1	013790850

## 1380BA

maço anti-faísca, cabo em madeira



g	L1 mm	L mm	€	🔧	📦
1000	100	400	256,00	1	013800810
1500	118	400	311,00	1	013800815
2000	126	449	411,00	1	013800820

## 1380BA/MR

cabo de substituição para ref. 1380BA

	€	🔧	📦
1380BA/MR 1000 1380BA/1000	25,50	1	013800860
1380BA/MR 1500 1380BA/1500	25,50	1	013800865
1380BA/MR 2000 1380BA/2000	25,50	1	013800870

# Beta

## 1381BA

martelos anti-faísca, cabos em madeira



g	L1 mm	L mm	€	🔧	📦
5000	179	900	954,00	1	013810850
*8000	190	900	1.530,00	1	013810858

## 1381BA/MR

cabo de substituição para ref. 1381BA

	€	🔧	📦
1381BA/MR 5000 1381BA/5000	41,50	1	013810870
*1381BA/MR 8000 1381BA/8000	48,00	1	013810878

## 1390BA

martelo anti-faísca com superfície de contacto macia



Ø mm	L mm	L1 mm	€	🔧	📦
*52	370	130	205,00	1	013900805

## 1390BA/R

batentes sobresselentes em nylon para artigo 1390BA



D mm	€	🔧	📦
52	41,50	4	013900885

## 1602BA

alicate para cravar terminais anti-faísca para terminais isolados, série ligeira



mm²	L mm	€	🔧	📦
0.75÷6	200	253,00	1	016020801

### 1701BA

escopros sextavados anti-faísca



L mm	A mm	S mm	€	Hand icon	Truck icon
150	12	10	47,00	1	017010810
200	16	14	75,50	1	017010814
250	18	14	91,50	1	017010815
350	19	17	239,00	1	017010817

### 1703BA/A

machado anti-faísca



L mm	L1 mm	A mm	€	Hand icon	Truck icon
340	145	82	210,00	1	017030082

### 1703BA/P

picareta anti-faísca



A mm	L mm	L1 mm	€	Hand icon	Truck icon
56	1050	410	551,00	1	017030150

### 1703BA/PL

pá anti-faísca



A mm	L1 mm	L mm	€	Hand icon	Truck icon
240	420	990	457,00	1	017030200



### 1717BA

espátula rígida anti-faísca



A mm	€	Hand icon	Truck icon
60	111,00	1	017170801
80	123,00	1	017170803

### 1717BA/1

raspador anti-faísca



A mm	L mm	€	Hand icon	Truck icon
100	220	226,00	1	017170805

### 1719BA8

limas 8" anti-faísca



	L mm	€	Hand icon	Truck icon
1719BA8/P	200	136,00	1	017190801
1719BA8/M	200	140,00	1	017190805
1719BA8/R	200	143,00	1	017190810
1719BA8/T	200	131,00	1	017190815
1719BA8/Q	200	131,00	1	017190820

### 1719BA12

limas 12" anti-faísca



	L mm	€	Hand icon	Truck icon
1719BA12/P	300	246,00	1	017190831

### 1727BA

serrote e folha anti-faísca



L mm	L1 mm	€	Hand icon	Truck icon
500	300	444,00	1	017270801

### 1728BA

lâminas anti-faísca para serrotes, em liga de cobre-berílio



L mm	€	Hand icon	Truck icon
300	86,50	1	017280801

### 1737BA

escova de arame anti-faísca



L mm	A mm	€	Hand icon	Truck icon
294	29	56,00	1	017370801

### 1776BA

navalha anti-faísca



L1 mm	L mm	€	Hand icon	Truck icon
145	250	123,00	1	017760801

### 1784BA

tesoura anti-faísca



L mm	€	Hand icon	Truck icon
225	215,00	1	017840822



## 1972/12

aparafusadora de impacto, 12V

- ultracompacta com 176 mm de comprimento; ultraleve com 1.1 kg de peso, com bateria, perfeitamente equilibrada
- velocidade mecânica dupla com engrenagens de aço e embraiagem de 18 posições
- binário até 34 Nm e 1500 rpm (350 rpm na 1ª engrenagem); perfura diâmetros até 10 mm em aço e 20 mm em madeira
- baterias 2Ah e indicador de carga no corpo da aparafusadora
- autoproteção tripla da bateria (calor, sobrecarga e monitorização das diferenças de carga (caso existam) entre células) para segurança aumentada e alta performance durável
- punho ergonómico antiderrapante
- LED frontal
- bucha de aperto rápido 10 mm
- clip para cinto (direita/esquerda)
- seletor, bloqueio modos aparafusar/desaparafusar (para transporte)
- fornecido em mala com 2 baterias de lítio ion (2 Ah) e carregador rápido (45 min)

1,1 kg



1972/12

€ 310,00 1 019720012

## 1972/18

berbequim de percussão, 18 V, sem escovas -ultracompacto-

motor digital sem escovas: desempenho notavelmente melhorado, incluindo: aumento de potência, consumo de energia reduzido, vida útil prolongada do motor, excepcionalmente compacto, controlo de potência no interruptor.

- binário até 75 Nm e 2100 rpm (550 rpm na 1ª engrenagem); diâmetros de perfuração até 13 mm em aço e 45 mm em madeira
- ultracompacto: 192 mm de comprimento
- bucha em aço 13 mm com porca de anel na ponta, para não danificar as superfícies em caso de fricção
- velocidade mecânica dupla com engrenagens em aço e comutador para perfuração, percussão e aparafusar, com embraiagem de 20 posições
- caixa de engrenagem inteiramente em metal, para maior robustez e durabilidade
- baterias 5Ah com indicador de carga
- autoproteção tripla da bateria (calor, sobrecarga e monitorização das diferenças de carga (caso existam) entre células) para segurança aumentada e alta performance durável
- clip para cinto (direita/esquerda)
- LED frontal
- com punho lateral para utilização com binário elevado
- seletor, bloqueio modos aparafusar/desaparafusar (para transporte)
- punho ergonómico antiderrapante
- fornecido em mala com 2 baterias lítio ion (5 Ah) e carregador rápido (80 min)

2,2 kg



1972/18

€ 765,00 1 019720018

## 1982/12EF

chave de impacto reversível, 12V  
ideal para trabalhos em espaços apertados, binário elevado (115 Nm),  
operação com uma só mão

- 0-2,000 rpm / 0-3,000 rpm
- baterias 2Ah com indicador de carga no corpo da chave
- ultracompacta: 163 mm de comprimento; ultraleve: 1.1 kg de peso, com bateria, equilíbrio perfeito
- encabadouro sextavado 1/4" com porca de bloqueio
- clip para cinto (direita/esquerda)
- triple LED frontal
- seletor, bloqueio modos aparafusar/desaparafusar (para transporte)
- punho ergonómico antiderrapante
- caixa de engrenagem inteiramente em metal
- autoproteção tripla da bateria (calor, sobrecarga e monitorização das diferenças de carga (caso existam) entre células) para segurança aumentada e alta performance durável
- fornecido em mala com 2 baterias de lítio ion (2 Ah) e carregador rápido (45 min)

1,1 kg



1982/12EF

€ 335,00 1 019820012

## 1984/18QM

chave de impacto reversível, 18V, sem escovas

motor digital sem escovas: desempenho notavelmente melhorado, incluindo:  
aumento de potência, consumo de energia reduzido, vida útil prolongada do motor, excepcionalmente compacto, controlo de potência no interruptor.

- baterias 5Ah com indicador de carga
- ultracompacta: 196 mm de comprimento
- encabadouro macho 1/2" com anel de retenção
- clip para cinto (direita/esquerda)
- triplo LED frontal
- caixa de engrenagem inteiramente em metal
- seletor, bloqueio modos aparafusar/desaparafusar (para transporte)
- punho ergonómico antiderrapante
- autoproteção tripla da bateria (calor, sobrecarga e monitorização das diferenças de carga (caso existam) entre células) para segurança aumentada e alta performance durável

4 modos disponíveis:

1: 270Nm; 1400 RPM

2: 360Nm; 2000 RPM

3: 450Nm; 2750 RPM

A: 450Nm Autostop - se a chave de impacto detetar uma rotação livre, aplica o binário/velocidade máximos (450Nm; 2750 RPM)

quando a porca atinge a extremidade do curso e pára de girar, a chave de impacto continua a aplicar o binário máximo durante 1 segundo, em seguida ajusta-se ao nível mais baixo, para evitar danificar a porca

- fornecida em mala de transporte com adaptador porta-bits sextavado (1/4"), 2 baterias lítio ion (5 Ah) e carregador rápido (80 min)

2,3 kg



1984/18QM

€ 890,00 1 019840018

# FERRAMENTAS PNEUMÁTICAS E ACESSÓRIOS

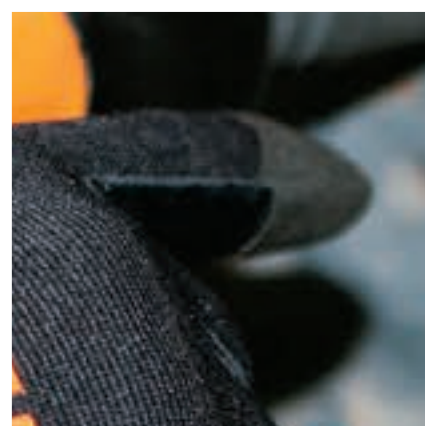
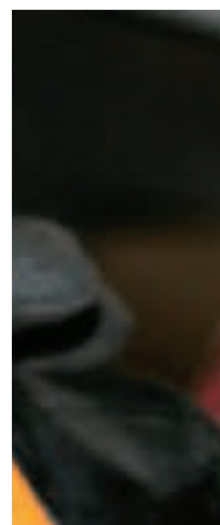

Nos últimos 15 anos, a Beta Utensili tem vindo a complementar a sua linha de produtos com uma selecção abrangente de ferramentas pneumáticas e acessórios desenvolvidos para os mercados de manutenção automóvel e industrial: chaves de impacto, roquetes, berbequins, rectificadoras, lixadeiras e muitos outros produtos.

Durante este período, a cooperação estreita com os utilizadores profissionais tem sido a chave para o crescimento contínuo. É com base nesse crescimento que as ferramentas pneumáticas Beta apresentam uma excelente relação fiabilidade/desempenho. Para satisfazer as exigências do mercado, a Beta Utensili efectua a reparação das ferramentas pneumáticas no seu Departamento de Qualidade. Este processo permitiu melhorar o seu know-how de forma significativa e tornar-se cada vez mais sensível à carteira de clientes.



## 1921B1

mini roquete pneumático reversível

1/4"

CE



Rotação em vazio	350 rpm
Torque max.	24 Nm
Capacidade parafuso	Cl 8.8 M7●11 mm
Capacidade parafuso	Cl 12.9 M6●10 mm
Entrada de ar	1/4" GAS
Pressão de trabalho	6,2 bar
(Ø) interno do tubo	8 mm
Consumo médio de ar	68 l/min
Peso	0,4 kg

1/4	€	1	019210001
	201,00		

## 1921M1

roquete pneumático reversível

1/4"

CE



Rotação em vazio	200 rpm
Torque max.	27 Nm
Capacidade parafuso	Cl 8.8 M7●11 mm
Capacidade parafuso	Cl 12.9 M6●10 mm
Entrada de ar	1/4" GAS
Pressão de trabalho	6,2 bar
(Ø) interno do tubo	8 mm
Consumo médio de ar	96 l/min
Peso	0,6 kg

1/4	kg	€	1	019210005
	0,6	178,00		

## 1921M2

roquete pneumático compacto reversível

3/8"

CE



Rotação em vazio	200 rpm
Torque max.	27 Nm
Capacidade parafuso	Cl 8.8 M7●11 mm
Capacidade parafuso	Cl 12.9 M6●10 mm
Entrada de ar	1/4" GAS
Pressão de trabalho	6,2 bar
(Ø) interno do tubo	8 mm
Consumo médio de ar	96 l/min
Peso	0,6 kg

3/8	kg	€	1	019210015
	0,6	178,00		

## 1921N3

roquete pneumático reversível

1/2"

CE



Rotação em vazio	150 rpm
Torque max.	68 Nm
Capacidade parafuso	Cl 8.8 M10●16 mm
Capacidade parafuso	Cl 12.9 M8●13 mm
Entrada de ar	1/4" GAS
Pressão de trabalho	6,2 bar
(Ø) interno do tubo	10 mm
Consumo médio de ar	140 l/min
Peso	1,2 kg

1/2	kg	€	1	019210025
	1,2	178,00		

## 1922P1

roquete reversível com superfície de percussão

• Dispositivo de impulso especial "Double rocking dog"

1/4"

CE



Velocidade	700 rpm
Binário máximo	68 Nm
Capacidade do parafuso	Cl 8.8 M10●16 mm
Capacidade do parafuso	Cl 12.9 M8●13 mm
Entrada de ar	1/4" GAS
Pressão de trabalho	6,2 bar
Ø interno do tubo	10 mm
Consumo médio de ar	88 l/min
Peso	0,6 kg

1/4	kg	€	1	019220006
	0,6	215,00		

## 1922P2

roquete reversível com superfície de percussão

• Dispositivo de impulso especial "Double rocking dog"

3/8"

CE



Velocidade	700 rpm
Binário máximo	68 Nm
Capacidade do parafuso	Cl 8.8 M10●16 mm
Capacidade do parafuso	Cl 12.9 M8●13 mm
Entrada de ar	1/4" GAS
Pressão de trabalho	6,2 bar
Ø interno do tubo	10 mm
Consumo médio de ar	88 l/min
Peso	0,6 kg

3/8	kg	€	1	019220010
	0,6	215,00		

## 1922P3

roquete reversível com superfície de percussão

• Dispositivo de impulso especial "Double rocking dog"

1/2"

CE



Velocidade	600 rpm
Binário máximo	136 Nm
Capacidade do parafuso	Cl 8.8 M12●18 mm
Capacidade do parafuso	Cl 12.9 M10●16 mm
Entrada de ar	1/4" GAS
Pressão de trabalho	6,2 bar
Ø interno do tubo	10 mm
Consumo médio de ar	113 l/min
Peso	1,5 kg

1/2	kg	€	1	019220013
	1,5	342,00		

## 1924F

chave de impacto reversível tipo borboleta

• Dispositivo de impulso especial "Double rocking dog"

3/8"

CE



Velocidade	12,000 rpm
Binário máximo	108 Nm
Capacidade do parafuso	Cl 8.8 M12●18 mm
Capacidade do parafuso	Cl 12.9 M10●16 mm
Entrada de ar	1/4" GAS
Pressão de trabalho	6,2 bar
Ø interno do tubo	10 mm
Consumo médio de ar	59 l/min
Peso	0,5 kg

3/8	kg	€	1	019240025
	0,5	200,00		

# Beta

## 1924B

chave de impacto compacta reversível

- Dispositivo de impacto "Pin Clutch"



Rotação em vazio	10,000 rpm
Torque máx.	353 Nm
Capacidade parafuso	Cl 8.8 M16 ● 24 mm
Capacidade parafuso	Cl 12.9 M14 ● 21 mm
Entrada de ar	1/4" GAS
Pressão de trabalho	6,2 bar
(Ø) interno do tubo	8 mm
Consumo médio de ar	80 l/min
Peso	1,5 kg

3/8 kg 232,00 € 1 019240021

## 1927CD

chave de impacto pneumática reversível, em material compósito

- Dispositivo de impacto duplo



Rotação em vazio	7,000 rpm
Torque máx.	1.020 Nm
Capacidade parafuso	Cl 8.8 M22 ● 34 mm
Capacidade parafuso	Cl 12.9 M18 ● 27 mm
Entrada de ar	1/4" GAS
Pressão de trabalho	6,2 bar
(Ø) interno do tubo	10 mm
Consumo médio de ar	130 l/min
Peso	1,9 kg

1/2 kg 368,00 € 1 019270007

## 1927XM

chave de impacto compacta reversível

- Dispositivo de impacto simples



Velocidade livre	10,000 rpm
Torque máx.	770 Nm
Capacidade parafuso	Cl 8.8 M22 ● 34 mm
Capacidade parafuso	Cl 12.9 M18 ● 27 mm
Entrada de ar	1/4" GAS
Pressão de trabalho	6,2 bar
Dimens. tubo interno (Ø)	10 mm
Consumo de ar médio	122 l/min
Peso	1.3 kg

1/2 kg 236,00 € 1 019270030

## 1924CD

chave de impacto pneumática reversível, em material compósito

- Dispositivo de impacto duplo



Rotação em vazio	10,000 rpm
Torque máx.	410 Nm
Capacidade parafuso	Cl 8.8 M16 ● 24 mm
Capacidade parafuso	Cl 12.9 M14 ● 21 mm
Entrada de ar	1/4" GAS
Pressão de trabalho	6,2 bar
(Ø) interno do tubo	8 mm
Consumo médio de ar	79 l/min
Peso	1,3 kg

3/8 kg 319,00 € 1 019240007

## 1927P

chave de impacto reversível em material compósito

- Mecanismo de impacto duplo



Velocidade	7,500 rpm
Binário máx.	1.750 Nm
Capacidade do parafuso	Cl 8.8 M24 ● 36 mm
Capacidade do parafuso	Cl 12.9 M20 ● 30 mm
Entrada de ar	1/4" GAS
Pressão de trabalho	6,2 bar
Diâm. interno do tubo	10 mm
Consumo médio de ar	290 l/min
Peso	2 kg

1/2 kg 423,00 € 1 019270008

## 1927A

chave de impacto reversível

- Mecanismo de impacto "Pin Clutch"



Velocidade	7,000 rpm
Binário máx.	610 Nm
Capacidade do parafuso	Cl 8.8 M22 ● 34 mm
Capacidade do parafuso	Cl 12.9 M18 ● 27 mm
Entrada de ar	1/4" GAS
Pressão de trabalho	6,2 bar
Diâm. interno do tubo	10 mm
Consumo médio de ar	160 l/min
Peso	2.7 kg

1/2 kg 199,00 € 1 019270002



## 1927AN

Chave de impacto angular reversível

- Dispositivo de impacto simples

1/2"

CE



rotações em vazio	4,700 rpm
Binário máx.	244 Nm
Capacidade parafuso	CI 8.8 M14 ● 21 mm
Capacidade parafuso	CI 12.9 M12 ● 19 mm
Entrada de ar	1/4" GAS
Pressão de trabalho	6,2 bar
Ø interno do tubo	10 mm
Consumo médio de ar	190 l/min
Peso	2.1 kg

1/2"	kg	€	1	019270012
2,1		419,00		

## 1927SP-AM

suporte magnético para chave de impacto

- Possui dois ímãs de elevado magnetismo com protecção de borracha nas extremidades
- Pode alojar 1 chave de impacto 1/2", 4 chaves de caixa e 1 chave dinamométrica
- Capacidade: 10 kg



400	kg	€	1	019270000
		46,50		

# Beta

## 1928CD

chave de impacto pneumática reversível, em material compósito

- Dispositivo de impacto duplo

3/4"

CE



Rotação em vazio	4,500 rpm
Torque máx.	1.800 Nm
Capacidade parafuso	CI 8.8 M27 ● 41 mm
Capacidade parafuso	CI 12.9 M24 ● 36 mm
Entrada de ar	3/8" GAS
Pressão de trabalho	6,2 bar
(Ø) interno do tubo	10 mm
Consumo médio de ar	215 l/min
Peso	3,5 kg

3/4"	kg	€	1	019280007
3,5		870,00		

## 1928DA

chave de impacto pneumática reversível

- Dispositivo de impacto duplo

3/4"

CE



Rotação em vazio	5,000 rpm
Torque máx.	1.695 Nm
Capacidade parafuso	CI 8.8 M27 ● 41 mm
Capacidade parafuso	CI 12.9 M24 ● 36 mm
Entrada de ar	3/8" GAS
Pressão de trabalho	6,2 bar
(Ø) interno do tubo	10 mm
Consumo médio de ar	240 l/min
Peso	4,3 kg

3/4"	kg	€	1	019280022
4,3		678,00		

## 1928DAL

Chave de impacto pneumática reversível

- Dispositivo de impacto duplo

3/4"

CE

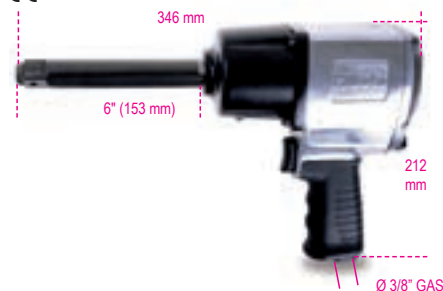

Rotação em vazio	5,000 rpm
Torque máx.	1.695 Nm
Capacidade parafuso	CI 8.8 M27 ● 41 mm
Capacidade parafuso	CI 12.9 M24 ● 36 mm
Entrada de ar	3/8" GAS
Pressão de trabalho	6,2 bar
(Ø) interno do tubo	10 mm
Consumo médio de ar	240 l/min
Peso	4,8 kg

3/4"	kg	€	1	019280023
4,8		718,00		

## 1928K4

jogo de uma chave pneumática de impacto com quatro chaves de caixa, série longa

- Dispositivo de impulso "Pin Clutch"

3/4"

CE



728L 27-30-32-36 mm

Rotação em vazio	4,000 rpm
Torque máx.	1.493 Nm
Capacidade parafuso	CI 8.8 M27 ● 41 mm
Capacidade parafuso	CI 12.9 M24 ● 36 mm
Entrada de ar	3/8" GAS
Pressão de trabalho	6,2 bar
(Ø) interno do tubo	10 mm
Consumo médio de ar	260 l/min
Peso chave de impacto pneumática	5,2 kg

3/4"	kg	€	1	019280104
9,3		690,00		
410x330x106 mm				

## 1930CD

chave de impacto pneumática reversível, em material compósito

• Dispositivo de impacto duplo



Rotação em vazio	4,000 rpm
Torque máx.	2.445 Nm
Capacidade parafuso	Cl 8.8 M36●55 mm
Capacidade parafuso	Cl 12.9 M30●46 mm
Entrada de ar	1/2" GAS
Pressão de trabalho	6,2 bar
(Ø) interno do tubo	13 mm
Consumo médio de ar	320 l/min
Peso	7,1 kg

1	kg	€	1	019300022
1	7,1	1.125,00		

## 1930PA

chave de impacto reversível

• Mecanismo de impacto duplo



Velocidade	3,500 rpm
Binário máx.	2.445 Nm
Capacidade do parafuso	Cl 8.8 M36●55 mm
Capacidade do parafuso	Cl 12.9 M30●46 mm
Entrada de ar	1/2" GAS
Pressão de trabalho	6,2 bar
Diâm. interno do tubo	13 mm
Consumo médio de ar	350 l/min
Peso	9,6 kg

1	kg	€	1	019300032
1	9,6	1.010,00		

## 1930A

chave de impacto reversível

• Dispositivo de impacto duplo



Velocidade em vazio	4,000 rpm
Binário máx.	2.445 Nm
Capacidade parafuso	Cl 8.8 M36●55 mm
Capacidade parafuso	Cl 12.9 M30●46 mm
Entrada de ar	1/2" GAS
Pressão de trabalho	6,2 bar
(Ø) interno do tubo	13 mm
Consumo médio de ar	460 l/min
Peso	9,5 kg

1	kg	€	1	019300036
1	9,5	1.020,00		

## 1930NCD

chave de impacto pneumática reversível, em material compósito

• Dispositivo de impacto duplo



Rotação em vazio	4,000 rpm
Torque máx.	2.445 Nm
Capacidade parafuso	Cl 8.8 M36●55 mm
Capacidade parafuso	Cl 12.9 M30●46 mm
Entrada de ar	1/2" GAS
Pressão de trabalho	6,2 bar
(Ø) interno do tubo	13 mm
Consumo médio de ar	320 l/min
Peso	8,8 kg

1	kg	€	1	019300027
1	8,8	1.180,00		

## 1930LA

chave pneumática de impacto reversível

• Dispositivo de impacto duplo



Rotação em vazio	4,000 rpm
Torque máx.	2.445 Nm
Capacidade parafuso	Cl 8.8 M36●55 mm
Capacidade parafuso	Cl 12.9 M30●46 mm
Entrada de ar	1/2" GAS
Pressão de trabalho	6,2 bar
(Ø) interno do tubo	13 mm
Consumo médio de ar	460 l/min
Peso	10,6 kg

1	kg	€	1	019300037
1	10,6	1.055,00		

## 1930HLA

chave de pancada reversível

• Mecanismo de impacto duplo



Rotação em vazio	3,000 rpm
Torque máx.	3.661 Nm
Capacidade parafuso	Cl 8.8 M42●65 mm
Capacidade parafuso	Cl 12.9 M33●50 mm
Entrada de ar	1/2" GAS
Pressão de trabalho	6,2 bar
(Ø) interno do tubo	13 mm
Consumo médio de ar	460 l/min
Peso	16,4 kg

1	kg	€	1	019300040
1	16,4	1.485,00		

## 1930ZL

chave de pancada reversível

• Mecanismo de impacto duplo

1 1/2"  
CE



Rotação em vazio	3,000 rpm
Torque máx.	4.068 Nm
Capacidade parafuso	Cl 8.8 M42 ● 65 mm
Capacidade parafuso	Cl 12.9 M36 ● 55 mm
Entrada de ar	1/2" GAS
Pressão de trabalho	6,2 bar
(Ø) interno do tubo	13 mm
Consumo médio de ar	480 l/min
Peso	15 kg

1 1/2" 15 kg 1.875,00 € 1 019300070

## 1931CD10

berbequim pneumático reversível, em material composto



Rotação em vazio	1,800 rpm
Capacidade da bucha	1+10 mm
Potência	0,38 kW
Rosca do veio	3/8" - 24UNF
Entrada de ar	1/4" GAS
Pressão de trabalho	6,2 bar
(Ø) interno do tubo	10 mm
Consumo médio de ar	170 l/min
Peso	1 kg

1,0 kg 192,00 € 1 019310010

## 1931AN10

berbequim pneumático angular reversível



Rotação em vazio	1,400 rpm
Capacidade da bucha	1+10 mm
Potência	0,38 kW
Rosca do veio	3/8" - 24UNF
Entrada de ar	1/4" GAS
Pressão de trabalho	6,2 bar
(Ø) interno do tubo	10 mm
Consumo médio de ar	150 l/min
Peso	1,1 kg

1,1 kg 213,00 € 1 019310030

## 1931CD6

berbequim pneumático reversível, em material composto



Rotação em vazio	2,600 rpm
Capacidade da bucha	1+6 mm
Potência	0,23 kW
Rosca do veio	3/8" - 24UNF
Entrada de ar	1/4" GAS
Pressão de trabalho	6,2 bar
(Ø) interno do tubo	8 mm
Consumo médio de ar	130 l/min
Peso	0,6 kg

0,6 kg 213,00 € 1 019310006

## 1931CD13

berbequim pneumático reversível, em material composto



Rotação em vazio	800 rpm
Capacidade da bucha	1,5+13 mm
Potência	0,38 kW
Rosca do veio	1/2" - 20UNC
Entrada de ar	1/4" GAS
Pressão de trabalho	6,2 bar
(Ø) interno do tubo	10 mm
Consumo médio de ar	170 l/min
Peso	1,3 kg

1,3 kg 284,00 € 1 019310013

## 1932B10

berbequim pneumático reversível



Rotação em vazio	1,800 rpm
Capacidade da bucha	1+10 mm
Potência	0,23 kW
Rosca do veio	3/8" - 24UNF
Entrada de ar	1/4" GAS
Pressão de trabalho	6,2 bar
(Ø) interno do tubo	10 mm
Consumo médio de ar	160 l/min
Peso	1,2 kg

1,2 kg 153,00 € 1 019320040

## 1932RS13

berbequim pneumático reversível



Rotação em vazio	750 rpm
Capacidade da bucha	1,5÷13 mm
Potência	0,23 kW
Rosca do veio	3/8" - 24UNF
Entrada de ar	1/4" GAS
Pressão de trabalho	6,2 bar
(Ø) interno do tubo	10 mm
Consumo médio de ar	160 l/min
Peso	1,4 kg

kg	€	1	019320043
1,4	195,00		

## 1932B13

berbequim pneumático reversível



Rotação em vazio	400 rpm
Capacidade da bucha	1,5÷13 mm
Potência	0,34 kW
Rosca do veio	1/2" - 20UNC
Consumo de ar	1/4" GAS
Pressão de trabalho	6,2 bar
Ø interno do tubo	10 mm
Consumo médio de ar	180 l/min
Peso	1,6 kg

kg	€	1	019320004
1,6	223,00		

## 1933

rectificadora pneumática

• Pinça de Ø 3 mm e 6 mm



Rotação em vazio	25,000 rpm
Capacidade da pinça	3 - 6 mm
Potência	0,20 kW
Entrada de ar	1/4" GAS
Pressão de trabalho	6,2 bar
(Ø) interno do tubo	10 mm
Consumo médio de ar	230 l/min
Peso	380 g

g	€	1	019330001
380	113,00		

## 1933I

rectificadora pneumática

• Bucha colectora, Ø 3 mm e 6 mm



Rotação em vazio	20,000 rpm
Capacidade da bucha	3 - 6 mm
Potência	0,38 kW
Entrada de ar	1/4" GAS
Pressão de trabalho	6,2 bar
(Ø) interno do tubo	10 mm
Consumo médio de ar	260 l/min
Peso	670 g

g	€	1	019330005
670	128,00		

## 1933L

rectificadora pneumática longa

• Bucha colectora, Ø 3 mm e 6 mm



Rotação em vazio	25,000 rpm
Capacidade da bucha	3 - 6 mm
Potência	0,20 kW
Entrada de ar	1/4" GAS
Pressão de trabalho	6,2 bar
(Ø) interno do tubo	10 mm
Consumo médio de ar	270 l/min
Peso	670 g

g	€	1	019330015
670	144,00		

## 1933IL

rectificadora de veio longo

• Bucha colectora, Ø 3 mm e 6 mm



Rotação em vazio	20,000 rpm
Capacidade da bucha	3 - 6 mm
Potência	0,38 kW
Entrada de ar	1/4" GAS
Pressão de trabalho	6,2 bar
(Ø) interno do tubo	10 mm
Consumo médio de ar	113 l/min
Peso	1,4 kg

kg	€	1	019330010
1,4	174,00		

## 1933AN90

rectificadora pneumática angular

• Bucha colectora, Ø 3 mm e 6 mm



Rotação em vazio	20,000 rpm
Capacidade da bucha	3 - 6 mm
Potência	0,20 kW
Entrada de ar	1/4" GAS
Pressão de trabalho	6,2 bar
(Ø) interno do tubo	10 mm
Consumo médio de ar	230 l/min
Peso	510 g

g	€	1	019330020
510	144,00		

## 1934BV

rectificadora de baixa rotação para pneus

• Bucha colectora, Ø 3 mm e 6 mm



Velocidade	3,700 rpm
Capacidade da bucha	3 - 6 mm
Potência	0,37 kW
Entrada de ar	1/4" GAS
Pressão de trabalho	6,2 bar
Diâm. interno do tubo	10 mm
Consumo médio de ar	113 l/min
Peso	0,84 kg

kg	€	1	019340000
0,84	154,00		

## 1934MAV

micro rectificadora

CE



Velocidade	56,000 rpm
Capacidade da bucha	3 mm
Potência	0,04 kW
Entrada de ar	1/4" GAS
Pressão de trabalho	6,2 bar
Diâm. interno do tubo	4,5 mm
Consumo médio de ar	115 l/min
Peso	0.2 kg

g 205 € 135,00 1 019340010

## 1934MAV70

micro-rectificadora de alta rotação

CE



Velocidade	70,000 rpm
Capacidade da bucha	3 mm
Potência	0,08 kW
Entrada de ar	1/4" GAS
Pressão de trabalho	6,2 bar
Diâm. interno do tubo	4,5 mm
Consumo médio de ar	115 l/min
Peso	0.21 kg

g 210 € 224,00 1 019340030

## 1935F

aparafusadora pneumática reversível

1/4

CE



Rotação em vazio	800 rpm
Torque máximo	4-16 Nm
Capacidade parafuso	6-9 M
Quadra	● 1/4"
Entrada de ar	1/4" GAS
Pressão de trabalho	6,2 bar
(Ø) interno do tubo	10 mm
Consumo médio de ar	150 l/min
Peso	1,3 kg

kg 1,3 € 215,00 1 019350045

## 1936/4A

rebarbadora

CE



Rotações em vazio	11,000 rpm
Dimensões do disco	115 mm
Potência	0,66 kW
Rosca do veio	M14
Entrada de ar	1/4" GAS
Pressão de trabalho	6,2 bar
(Ø) interno do tubo	10 mm
Consumo médio de ar	390 l/min
Peso	1.77 kg

kg 1,8 € 350,00 1 019360024

## 1936/5A

rebarbadora pneumática

CE



Rotações em vazio	10,000 rpm
Dimensões do disco	125 mm
Potência	0,66 kW
Rosca do veio	M14
Entrada de ar	1/4" GAS
Pressão de trabalho	6,2 bar
(Ø) interno do tubo	10 mm
Consumo médio de ar	390 l/min
Peso	1,9 kg

kg 1,9 € 350,00 1 019360025

## 1936/5

rebarbadora pneumática angular com punho lateral

CE



Rotações em vazio	10,500 rpm
Dimensões do disco	125 mm
Potência	0,7 kW
Rosca do veio	M14
Entrada de ar	1/4" GAS
Pressão de trabalho	6,2 bar
(Ø) interno do tubo	10 mm
Consumo médio de ar	380 l/min
Peso	2 kg

kg 2,0 € 509,00 1 019360005

 Beta

## 1936/7

rebarbadora pneumática angular com punho lateral

CE



Rotações em vazio	7,000 rpm
Dimensões do disco	178 mm
Potência	1,4 kW
Rosca do veio	M14
Entrada de ar	3/8" GAS
Pressão de trabalho	6,2 bar
(Ø) interno do tubo	13 mm
Consumo médio de ar	500 l/min
Peso	3,6 kg

kg	€		
3,6	730,00	1	019360007

## 1937

Lixadeira de disco orbital, isenta de lubrificação, em material compósito

• Diâmetro orbital: 5 mm

CE



Oscilações em vazio	12,000 rpm
Potência	0,18 kW
Diâmetro do disco	150 mm
Diâmetro orbital	5 mm
Rosca do veio	5/16"-24
Entrada de ar	1/4" GAS
Pressão de trabalho	6,2 bar
Ø interno do tubo	10 mm
Consumo médio de ar	170 l/min
Peso	0,86 kg

kg	€		
0,86	379,00	1	019370001

## 1937R/P

prato 6 furos, Ø 150 mm, para ref. 1937



1937R/P	€		
	39,00	1	019370002

## 1937KC

mini lixadeira roto-orbital

- Diâmetro orbital 4 mm
- 2 discos de lixar (Ø 50 mm e Ø 75 mm)
- 10 discos de lixa abrasiva (Ø 50 mm), grão 400, 600, 800
- 10 discos de lixa abrasiva (Ø 75 mm), grão 400, 600, 800

CE



Velocidade livre	15000
Potência	0,25
Dimensões disco	50 - 75
Rosca do veio	M6 x 1,0
Entrada de ar	1/4"
Pressão de trabalho	6,2 bar
Dimensão interna tubo (Ø)	10
Consumo médio de ar	79
Peso lixadeira	0,64
Peso do kit	1,4

kg	€		
1,4	213,00	1	019370171

## 1937C...

discos de lixa abrasiva para artigo 1937KC



Ø mm	P	€		
50	400	12,00	1	019370175
50	600	12,00	1	019370176
50	800	12,00	1	019370177
75	400	15,50	1	019370178
75	600	15,50	1	019370179
75	800	15,50	1	019370180

\* Preços para 10 unidades



# Beta

## 1937KL

mini polidora

- Disco de polir (Ø 90 mm) - 1937/KL-DSB, 1937/KL-DSG
- Disco de polir em lã (Ø 90 mm) - 1937/KL-DLA

CE



Velocidade livre	3,200 rpm
Potência	0,25 kW
Dimensões disco	75 mm
Rosca do veio	M6
Entrada de ar	1/4" GAS
Pressão de trabalho	6,2 bar
Dimensão interna tubo (Ø)	10 mm
Consumo médio de ar	91 l/min
Peso polidora	0,75 kg
Peso do kit	1,8 kg

kg	€		
1,8	233,00	1	019370161

## 1937KL-D

acessórios para artigo 1937KL

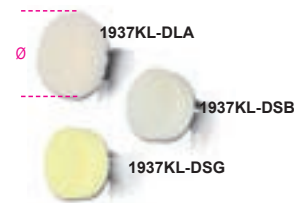

	Ø mm	€		
1937KL-DLA	90	20,50	1	019370164
1937KL-DSB	90	20,50	1	019370165
1937KL-DSG	90	20,50	1	019370166

## 1937K...

pratos para artigos 1937KC e 1937KL



	Ø mm	1937KC	1937KL	€		
1937KC-RP	50	•	•	22,50	1	019370173
1937KL-RP	75	•	•	27,50	1	019370163

## 1937RT

lixadeira de disco orbital, em material compósito, com sistema de aspiração

- Diâmetro orbital: 5 mm
- Prato Retangular (100x110 mm)
- Prato Delta (125x95 mm)

CE



Velocidade	10,000 rpm
Diâmetro orbital	5 mm
Entrada de ar	1/4" GAS
Pressão de trabalho	6,2 bar
Diâm. Interno do tubo (Ø)	10 mm
Consumo de ar médio	180 l/min
Peso	0,9 kg
Peso	0,9 kg

kg	€		
0,9	385,00	1	019370021

## 1937RT/R

prato retangular para artigo 1937RT



	L	L1	€		
1937RT/R	mm	mm			
	110	100	29,50	1	019370022

## 1937RT/T

prato Delta para artigo 1937RT



	L	L1	€		
1937RT/T	mm	mm			
	125	95	28,00	1	019370023

## 1937M

Lixadeira multiusos com 16 acessórios

CE



Rotações em vazio	3,500 rpm
Potência	0,34 kW
Entrada de ar	1/4" GAS
Pressão de trabalho	6,2 bar
(Ø) interno do tubo	10 mm
Consumo médio de ar	113 l/min
Peso lixadeira	1,5 kg
Peso kit	4,5 kg

kg	€		
4,5	630,00	1	019370011

458x495x116 mm

## 1937M-01÷11

acessórios para ref. 1937M



	L	1937M-	€		
1937M-01	mm				
1937M-02	30		23,50	1	019370101
1937M-03	30		23,50	1	019370102
1937M-04	11		20,50	1	019370103
1937M-05	23		20,50	1	019370104
1937M-06	11		20,50	1	019370105
1937M-07	23		20,50	1	019370106
* 1937M-08	16		58,00	1	019370107
1937M-09	13	07	20,50	1	019370108
1937M-10	26	07	20,50	1	019370109
1937M-11	11	03, 05	20,50	1	019370110
	23	01, 02, 04, 06	20,50	1	019370111

\* Os preços indicados são para 6 unidades

## 1937N10

Lixadeira de cinta pneumática, 10 mm

CE



Rotações em vazio	20,000 rpm
Potência	0,37 kW
Dimensões da cinta	10x330 mm
Entrada de ar	1/4" GAS
Pressão de trabalho	6,2 bar
(Ø) interno do tubo	10 mm
Consumo médio de ar	374 l/min
Peso	0,9 kg

kg	€		
0,9	248,00	1	019370041

## 1937N10-GR

cinta para ref. 1937N10



	P	€		
1937N10-GR60	60	25,50	1	019370146
1937N10-GR80	80	25,50	1	019370148
1937N10-GR100	100	25,50	1	019370150
1937N10-GR120	120	25,50	1	019370152

Os preços indicados são para 10 unidades

## 1937N20

lixadeira pneumática de cinta 20 mm

CE



Rotações em vazio	16,000 rpm
Potência	0,45 kW
Tamanho da cinta	20x520 mm
Entrada de ar	1/4" GAS
Pressão de trabalho	6,2 bar
(Ø) interno do tubo	10 mm
Consumo médio de ar	400 l/min
Peso	1,6 kg

kg	€		
1,6	288,00	1	019370051

**Beta**

## 1937N20-GR

cinta para ref. 1937N20



	P	€		
1937N20-GR60	60	33,00	1	019370156
1937N20-GR80	80	33,00	1	019370158
1937N20-GR100	100	33,00	1	019370160
1937N20-GR120	120	33,00	1	019370162

Os preços indicados são para 10 unidades

## 1938

Removedor de pára-brisas

• Fornecido com 1 espátula plana 57 mm

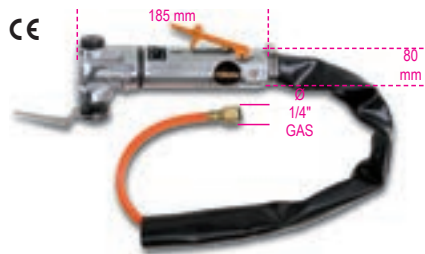

Oscilações/minuto	20,000
Entrada de ar	1/4" GAS
Pressão de trabalho	6,2 bar
Ø interno do tubo	6,5 mm
Consumo médio de ar	200 l/min
Peso	1,0 kg

kg	€		
1,0	195,00	1	019380021

## 1938R/L

espátulas para removedor de pára-brisas

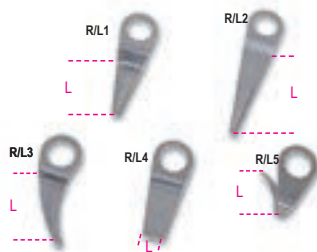

	L mm	€		
1938R/L1	57	16,00	1	019380041
1938R/L2	90	30,50	1	019380042
1938R/L3	50	18,00	1	019380043
1938R/L4	16	26,00	1	019380044
1938R/L5	36	30,00	1	019380045

## 1938R/S5

jogo de 5 espátulas para item 1938

	€		
1938R/S5	121,00	1	019380055

## 1940

martelo burilador pneumático



CE



Golpes por minuto	3,500
Encaixe do buril	Ø 11 mm
Dimensões do pistão	19 mm
Curso do pistão	67 mm
Entrada de ar	1/4" GAS
Pressão de trabalho	6,2 bar
(Ø) interno do tubo	8 mm
Consumo médio de ar	240 l/min
Peso	1,9 kg

kg	€		
1,9	158,00	1	019400001

## 1940MT

mola de fixação para refª. 1940



	€		
1940MT	10,00	5	019400110

## 1940S...

buris para martelo 1940



	€		
1940SN	12,50	5	019400020
1940ST	12,50	5	019400021
1940SD	12,50	5	019400022
1940SPS	12,50	5	019400023
1940SDT	12,50	5	019400024

## 1940/S5

jogo de 5 buris para 1940



	€		
1940/S5	57,00	1	019400030

## 1940E10

martelo pneumático

• Compatível com escopros com encabadouro 10 mm sextavado



CE



Impactos por minuto	2,900
Encabadouro escopro	Ø 10 mm
Dimens. pistão	19 mm
Curso pistão	67 mm
Entrada de ar	1/4" GAS
Pressão de trabalho	6,2 bar
Dimens. tubo interno (Ø)	10 mm
Consumo de ar médio	76 l/min
Peso	1,7 kg

kg	€		
1,7	172,00	1	019400010

## 1940E10/MT

mola de retenção sobresselente para artigo 1940E10



	€		
1940E10/MT	1,30	5	019400112

## 1940E10/S...

escopros para martelos pneumáticos 1940E10



	€		
1940E10/SN	8,50	5	019400040
1940E10/ST	8,50	5	019400041
1940E10/SD	8,50	5	019400042
1940E10/SPS	8,50	5	019400043
1940E10/SDT	8,50	5	019400044

## 1940E10/S5

jogo de 5 escopros para martelos pneumáticos 1940E10



	€		
1940E10/S5	42,50	1	019400050



## 1942A

serra pneumática

CE

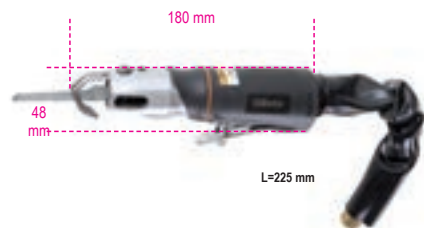

Oscilações por minuto	10.000
Curso	10 mm
Entrada de ar	1/4" GAS
Pressão de trabalho	6,2 bar
Ø interno do tubo	8 mm
Consumo médio de ar	75 l/min
Peso	550 g

kg	€	1	019420000
550	263,00		

## 1942LR

lâminas bimetetal para serra pneumática 1942A



1942LR	€	5	019420032
	6,00		

## 1944A

martelo de agulhas axial

CE



Impactos por minuto	3.800
Alcance	33 mm
Nº de agulhas	19
Dimensões da agulha (Ø)	3 mm
Entrada de ar	1/4" GAS
Pressão de trabalho	6,2 bar
Dimensão interna do tubo (Ø)	10 mm
Consumo de ar	85 l/min
Peso	2,8 kg

kg	€	1	019440011
2,8	298,00		

## 1944N

Martelo de agulhas

CE



Impactos por minuto	3800
Comprimento	33 mm
Nº de agulhas	19
Tamanho da agulha (Ø)	3 mm
Entrada de ar	1/4" GAS
Pressão de trabalho	6,2 bar
Tamanho interno da mangueira (Ø)	8 mm
Consumo de ar	85 l/min
Peso	2,7 kg

kg	€	1	019440002
2,7	379,00		

## 1944AR

jogo de agulhas para martelo de agulhas ref. 1944N, 1944A



	Ø mm	n.	€	1	019440015
1944AR 2	2	29	39,00		
1944AR 3	3	19	30,00		

## 1944PA

Placas de agulha para itens 1944N e 1944A



	Ø mm	N.	€	1	019440016
1944PA 2	2	29	43,00		
1944PA 3	3	19	32,00		

# Beta

# Beta

## 1945S

Agrafadora

• Agrafes tipo 80, seção comprimento de 0,95 x 0,65 mm (tamanho 21); 4-16 mm; largura: 12,8 mm



Capacidade	157 unid.
Entrada de ar	1/4" GAS
Pressão de trabalho	4,2 - 7 bar
Tamanho interno da mangueira (Ø)	8 mm
Consumo de ar (7 bar)	0,34 l/cycle
Peso	0,87 kg

kg	€	1	019450000
0,9	160,00		

## 1945C

Pistola para agrafes e pregos combinada

• Agrafes tipo 90, seção 1,25 x 1,0 mm (calibre 18), comprimento: 16 - 40 mm; largura: 5,8 mm  
• Pregos de cabeça redonda tipo B12, seção 1,25 x 1,0 mm (calibre 18), cabeça de 1,9 mm



Capacidade	100 unid.
Entrada de ar	1/4" GAS
Pressão de trabalho	5 - 8 bar
Tamanho da mangueira interna (Ø)	8 mm
Consumo de ar (7 bar)	1,12 l/cycle
Peso	1,16 kg

kg	€	1	019450200
1,16	210,00		

## 1945P

### Pistola para pinos

- Utiliza pinos tipo B6, Ø 0.64 mm (tamanho 23), comprimento: 12 - 35 mm



Capacidade	145 unid.
Entrada de ar	1/4" GAS
Pressão de trabalho	4 - 7 bar
Tamanho interno da mangueira (Ø)	8 mm
Consumo de ar (7 bar)	0.27 l/cycle
Peso	0.87 kg

kg	€	1	019450100
0,87	258,00		

## 1946T

### Rebitadora

- fornecido com bicos intercambiáveis de longa duração para aço, aço inoxidável, alumínio e rebites de cobre, 2.4-3.2-4.0-4.8 mm



Potência de tração	9,000 N
Comprimento de curso	16 mm
Capacidade máx do rebite	Aço inoxidável Ø 4.8 mm
Entrada de ar	1/4" GAS
Pressão de trabalho	6,2 bar
Tamanho interno da mangueira (Ø)	8 mm
Consumo de ar	2.0 l/cycle
Peso	1.7 kg

kg	€	1	019460021
1,7	230,00		

## 1946C4,8

### rebitadora

- Entrada de ar automática
- Fornecida montada para utilização com rebites de aço, aço inoxidável, alumínio e cobre com 2.4 - 3.2 - 4.0 - 4.8 mm



Potência de tração	8,900 N
Extensão do curso	15 mm
Capacidade máx. do rebite	Aço inoxidável Ø 4.8 mm
Entrada de ar	1/4" GAS
Pressão de trabalho	6,2 bar
Dimens. interna do tubo (Ø)	10 mm
Consumo de ar	2.6 l/ciclo
Peso	1.5 kg

kg	€	1	019460006
1,5	495,00		

## 1946C7,8

### rebitadora

- Entrada de ar automática
- Fornecida montada para utilização com rebites de aço, aço inoxidável, alumínio e cobre com 4.8 - 5.6 - 6.4 - 7.8 mm



Potência de tração	16,900 N
Extensão do curso	22.5 mm
Capacidade máx. do rebite	Aço inoxidável Ø 7.8 mm
Entrada de ar	1/4" GAS
Pressão de trabalho	6,2 bar
Dimens. interna do tubo (Ø)	10 mm
Consumo de ar	4.9 l/ciclo
Peso	1.8 kg

kg	€	1	019460008
1,8	785,00		

## 1946C/T...

### Cabeças de rebites



Ø mm	€	1	019460016
1946C/T4,8	4,8	30,00	
1946C/T6,4	6,4	30,00	1 019460018

## 1946KF

### rebitadora pneumática para rebites roscados

- Fornecida montada para rebites roscados em aço, aço inox, alumínio e cobre, M4, M5, M6, M8



Força de tração	14,235 N
Curso	7 mm
Capacidade máxima rebite	Aço inox Ø, M8
Entrada de ar	1/4" GAS
Pressão de trabalho	6,2 bar
Ø interno do tubo	10 mm
Consumo de ar	2.1 l/ciclo
Peso máquina	2.1 kg
Peso kit	3.4 kg

kg	€	1	019460012
3,4	1.640,00		

## 1946KF/M...

### bicos de substituição para rebitadora ref. 1946KF



1946KF/M4	€	1	019460124
1946KF/M5	53,50	1	019460125
1946KF/M6	53,50	1	019460126
1946KF/M8	53,50	1	019460128

## 1947

### pistola de colagem



Dimensões do tubo	50x210 mm
Capacidade do cartucho	350 ml
Entrada de ar	1/4" GAS
Pressão de trabalho	4,8 bar
(Ø) interno do tubo	10 mm
Consumo médio de ar	120 l/min
Peso	1,1 kg

kg	€	1	019470001
1,1	54,00		

## 1947H

pistola para isolantes



Dimensões do tubo	210x50 mm
Capacidade cartucho	300/310 ml
Entrada de ar	1/4" GAS
Pressão de trabalho	4 ÷ 8 bar
Dimens. tubo interno (Ø)	2,5 mm
Consumo de ar médio	120 l/min
Peso	750 g

g	€	1	019470011
750	196,00		

## 1947G

bomba de massa pneumática, com extensão e bico

Estrutura robusta em alumínio fundido  
 Punho ergonômico com inclinação perfeita para trabalhar em espaços apertados  
 Válvula em latão para maior vida útil  
 Capacidade: 500cc ou cartuchos de 400g  
 Dimensões do tubo: 54 (interior) x 260 mm  
 Entrada de ar: 1/4" GAS  
 Pressão de trabalho: 4÷10 bar  
 Peso: 1.9 kg

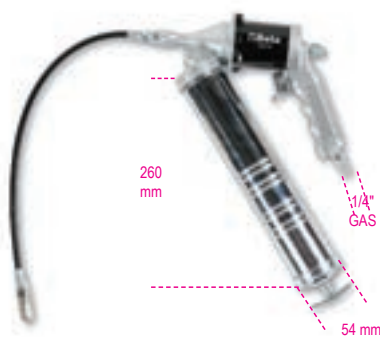

g	€	1	019470051
1947G	136,00		



## 1947M

pistola para isolantes monocomponente



Dimensões Tubo	210x50 mm
Capacidade do cartucho	310 ml
Entrada de ar	1/4" GAS
Pressão de trabalho	3 ÷ 5 bar
Bico Ø	1.6 - 2.5 mm
Consumo médio de ar	250 l/min
Peso	1.2 kg

kg	€	1	019470021
1,2	270,00		

## 1947M -...

Pistola para isolantes monocomponente- kit de Bicos de reposição para item 1947M

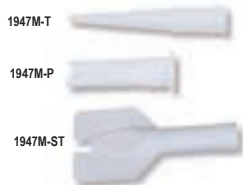

1947M-ST	€ 2,50	10	019470025
1947M-T	€ 1,50	10	019470026
1947M-P	€ 2,00	10	019470027

\* Preços para 10 unids.

## 1948

caneta de gravação



Dureza máxima	60 HRC
Entrada de ar	60 HRC
Pressão de trabalho	1/4" GAS
Consumo médio de ar	6,2 bar
Peso	50 l/min
Peso	150 g

g	€	1	019480001
150	255,00		

## 1948PR

ponta pastilhada em tungstênio para item 1948

• Dureza máx.: 60 HRC



1948PR	€ 99,00	1	019480005
--------	---------	---	-----------

## 1949BC

soprador progressivo com bico em borracha

• Corpo em material composto, anti-choque  
 • Bico substituível em borracha



Insert roscado em latão	1/4" GAS
Pressão de trabalho	6-8 bar
Pressão de trabalho máx.	15 bar
Consumo médio de ar	87 l/min
Temperatura de trabalho	-20°C ÷ 70°C
Peso	120 g

g	€	1	019490022
120	14,50		

## 1949BC/RU

5 bicos em borracha para item 1949BC



1949BC/RU	€ 18,50	1	019490122
-----------	---------	---	-----------



## 1949T

soprador progressivo telescópico

- Corpo em material composto, anti-desgaste e anti-choque
- Tubo telescópico giratório em aço: 165 mm + 300 mm

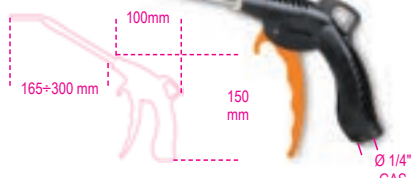

Insert roscado em latão  
Pressão de trabalho 6÷8 bar  
Pressão de trabalho máx. 15 bar  
Consumo médio de ar 144 l/min  
Pressão de trabalho -20°C ÷ 70°C  
Peso 190 g

g 190 € 23,70 5 019490040

## 1949F

soprador progressivo

- Em material composto anti-desgaste, à prova de riscos e embates, com isolamento térmico
- A válvula especial e a alavanca permitem uma abertura progressiva do circuito, otimizando o fluxo de ar



Insert roscado em latão  
Pressão de trabalho 6-8 bar  
Pressão de trabalho máx. 10 bar  
Pressão de trabalho -15°C ÷ 70°C  
Peso 130 g

g 130 € 13,40 5 019490027

## 1949G

soprador progressivo com regulação de ar

- Em material composto anti-desgaste, à prova de riscos e embates, com isolamento térmico
- A válvula especial e a alavanca permitem uma abertura progressiva do circuito, otimizando o fluxo de ar



Insert roscado em latão  
Pressão de trabalho 6-8 bar  
Pressão de trabalho máx. 10 bar  
Pressão de trabalho -15°C ÷ 70°C  
Peso 140 g

g 140 € 13,90 5 019490035

## 1949DGT

punho encher pneus digital

- Pressão de trabalho: 0÷11 bar (2,0÷160 psi)
- 4 unidades de medida: psi/bar/kgcm2/kpa
- Monitor LCD iluminado
- Opção Reset
- Funcionamento automático desliga após 3 min.
- Botão despressurização
- Resolução: 0.05 bar
- Caixa em ABS, protecção do manómetro em borracha, punho antiderrapante, à prova de embates
- Potência alimentação: 2 pilhas AAA, 1.5V
- Compatível com união 1916G 1/4"



1949DGT bar 0-11 g 500 € 136,00 1 019490020



## 1949GPE

punho de encher pneus

- Pressão de trabalho: 0÷11 bars (10÷160 psi)
- Função alívio da pressão
- Função medição da pressão
- Manómetro com revestimento em borracha anti-impacto
- Rotação do tubo a 360°



1949GPE bar 0÷11 g 640 € 108,00 1 019490008

## 1949GPN

punho de encher pneus, caixa em ABS

- Manómetro de pressão com certificação CE e escala 0.7÷12 bar (graduada a 1/10 bar)
- Dois botões de comando para enchimento preciso e rápido (+) e para esvaziar (-)
- Fornecido com certificado de calibragem
- Inclui resguardo de protecção anti-impacto e visor
- Equipado com união roscada 1/4" GAS
- Entrada de ar giratória para tubo em borracha, Ø 7 mm



1949GPN bar 0,7÷12 g 810 € 222,00 1 019490011

## 1949M

punho para medir a pressão dos pneus



1949M bar 0÷4 psi 5÷60 g 280 € 61,00 1 019490400

## 1951



Velocità libera 3.600 giri/min  
 Capacità serbatoio 1 L  
 Attacco aria 1/4" GAS  
 Pressione di utilizzo 6,2 bar  
 Ø interno tubo aria 8 mm  
 Consumo aria medio 110 l/min  
 Peso 650 g

650 g € 119,00 1 019510051

## 1901BM/8

enrolador automático  
 corpo de plástico à prova de choque  
 para ar comprimido ou água fria  
 • pressão Max. de operação: 12 bar

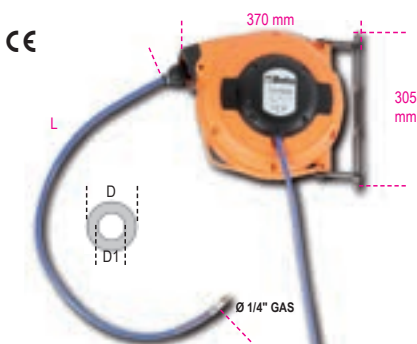

D1xD L Ø GAS  
 mm m mm BSP  
 8x12 9+1 1/4" € 219,00 1 019010111

## 1901T/10

enrolador para tubo de ar comprimido ou água fria, com corpo em plástico anti-impacto

• Pressão máx. de funcionamento: 12 bar



D1xD L Ø GAS  
 mm m mm BSP  
 10x14 15+1 3/8" € 260,00 1 019010210

## 1910/8 - 1910/10

enrolador de tubo automático,  
 corpo em alumínio,  
 para ar comprimido ou água fria  
 • Pressão de trabalho máx.: 15 bar



D1xD L A B ØGAS  
 mm m mm mm mm  
 8x12 9+1 375 130 1/4"

1910/8 € 342,00 1 019100008

D1xD L A B ØGAS  
 mm m mm mm mm  
 10x14 15+1 490 160 3/8"

1910/10 € 508,00 1 019100010

## 1914

tubo espiral em poliuretano, 98 Shore,  
 extensível

• Pressão de trabalho máxima: 12 bar



L D1xD Ø GAS  
 m mm mm BSP  
 4 5x8 1/4" € 20,00 1 019140054  
 6 5x8 1/4" € 23,30 1 019140056  
 10 5x8 1/4" € 30,50 1 019140060

## 1915B

tubo espiral em poliuretano, 95 Shore,  
 extensível até 9 m

• Pressão de trabalho máxima: 10 bar

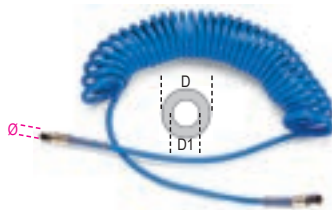

D1xD Ø GAS  
 mm mm BSP  
 6,5x10 1/4" € 35,00 1 019150011  
 8x12 1/4" € 41,00 1 019150012  
 11x16 3/8" € 68,00 1 019150013

## 1915C

tubo espiral em poliuretano, 95 Shore,  
 extensível até 12 m

• Pressão de trabalho máxima: 10 bar

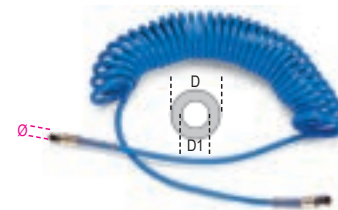

D1xD Ø GAS  
 mm mm BSP  
 6,5x10 1/4" € 41,00 1 019150014  
 8x12 1/4" € 51,00 1 019150015  
 11x16 3/8" € 84,00 1 019150016

## 1915C/L

tubo espiral em poliuretano, 95 Shore,  
 extensível até 15 m

• Pressão de trabalho máxima: 10 bar

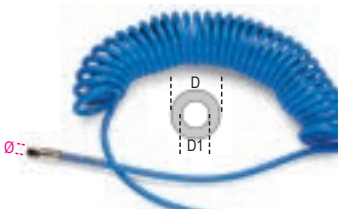

D1xD Ø GAS  
 mm mm BSP  
 8x12 1/4" € 66,50 1 019150115  
 11x16 3/8" € 110,00 1 019150116

## 1915D

tubo em poliuretano, 95 Shore, com 9 m

• Pressão de trabalho máxima: 15 bar



D1xD Ø GAS  
 mm mm BSP  
 8x12 1/4" € 41,50 1 019150017  
 11x16 3/8" € 66,50 1 019150018

## 1915E

tubo em poliuretano, 95 Shore, com 12 m

• Pressão de trabalho máxima: 15 bar



D1xD Ø GAS  
 mm mm BSP  
 8x12 1/4" € 55,00 1 019150019  
 11x16 3/8" € 83,00 1 019150020

**Beta**

## 1915E/XL

tubo em poliuretano, 95 Shore, com 50 m

• Pressão de trabalho máxima: 15 bar



D1xD	Ø GAS BSP	€	🔧	📄
8x12	1/4"	190,00	1	019150519
11x16	3/8"	318,00	1	019150520

## 1916I

uniões rápidas de perfil italiano rosca macho, cilíndricas (BSP)



Ø GAS BSP	€	🔧	📄
1/4"	2,70	5	019160001
3/8"	3,10	5	019160002

## 1916G

uniões rápidas de perfil europeu rosca macho, afuniladas (BSPT)



Ø GAS BSPT	€	🔧	📄
1/4"	2,60	5	019160005
3/8"	4,10	5	019160010
1/2"	4,10	5	019160012

## 1916GF

Engates rápidos, perfil europeu, rosca fêmea, cônico (BSPT)



Ø GAS BSPT	€	🔧	📄
1/4"	2,70	5	019160055
3/8"	3,10	5	019160060

## 1916JM

Engates rápidos de perfil asiático, rosca macho cônica (BSPT)



Ø GAS BSPT	€	🔧	📄
1/4"	3,80	1	019160406
3/8"	4,05	1	019160410

## 1916JF

Engates rápidos, perfil europeu, rosca fêmea, cilíndrico (BSP)



Ø GAS BSP	€	🔧	📄
1/4"	4,55	1	019160456
3/8"	4,75	1	019160460

## 1916R

Engates rápidos de perfil europeu com encaixe de cauda da mangueira afilado (BSPT)



D1 mm	€	🔧	📄
6	1,80	5	019160106
8	2,00	5	019160108
11	2,10	5	019160111

## 1917M

uniões de esferas universais, borracha à prova de impacto, rosca macho, cilíndricas (BSP)

• Adequadas para uniões 1916I e 1916G



Ø GAS BSP	€	🔧	📄
1/4"	11,00	5	019170001
3/8"	11,00	5	019170003
1/2"	11,50	5	019170004

## 1917F

Engates rápidos de esfera universal com borracha à prova de choque e fêmea com rosca cilíndrica (BSP)

• Engates 1916I e 1916G



Ø GAS BSP	€	🔧	📄
1/4"	11,50	5	019170005
3/8"	11,50	5	019170010
1/2"	12,00	5	019170014

## 1917JM

Engates rápidos de esferas, perfil asiático, rosca macho, cilíndrica (BSP)



Ø GAS BSP	€	🔧	📄
1/4"	19,50	1	019170406
3/8"	20,00	1	019170410
1/2"	20,50	1	019170412

## 1917JF

Engates rápidos de esferas, perfil asiático, rosca fêmea, cilíndrica (BSP)



Ø GAS BSP	€	🔧	📄
1/4"	20,00	1	019170456
3/8"	21,00	1	019170460

## 1917RG

Engate universal rotativo

- Fabricado em alumínio, rosca fêmea, cilíndrica (BSP) rosca macho, cilíndrica (BSP)
- Combina todos os engates com perfis italianos e europeus
- Gira livremente, mesmo sem área conectada



Ø GAS BSP	€	🔧	📄
1/4"	19,00	1	019170252

## 1918

Adaptador extremidade da mangueira, rosca macho



D1 mm	Ø GAS BSPT	€	🔧	📄
8	1/4"	2,70	3	019180008
10	3/8"	4,20	3	019180010
12	1/2"	6,40	3	019180012

## 1919FE1/4

filtro regulador lubrificador

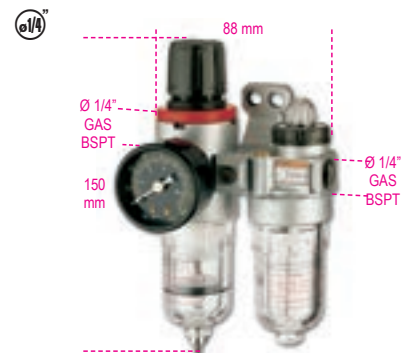

Entrada/saída de ar	1/4" GAS BSPT
Entrada manômetro de pressão	1/8" GAS BSPT
Capacidade pneumática máx.	750 l/min
Pressão máx.	9,5 bar
Pressão de trabalho	0,5 - 8,5 bar
Temperatura de trabalho	5 - 60 °C
Capacidade do filtro	5 micron
Capacidade recip.	15 cc ar / 25 cc óleo
Peso	700 g

g	€	🔧	📄
700	88,00	1	019190200

### 1919RB-FE1/4

jogo de copos de substituição para artigo 1919FE1/4



1919RB-FE1/4 € 18,50 1 019190210

### 1919RF-FE1/4

elemento filtrante de substituição para artigo 1919FE1/4



1919RF-FE1/4 € 5,00 1 019190230

### 1919RM-FE1/4

manómetro de substituição para artigo 1919FE1/4



1919RM-FE € 10,50 1 019190220

### 1919F1/4

filtro regulador lubrificador



Entrada/saída de ar 1/4" GAS BSPT  
Capacidade pneumática máx. 1000 l/min  
Pressão máx. 9,5 bar  
Pressão de trabalho 0,5 - 8,5 bar  
Temperatura de trabalho 5 - 60 °C  
Capacidade do filtro 5 microns  
Capacidade recip. 60 cc ar / 90 cc óleo  
Peso 1,3 kg

1919F1/4 € 137,00 1 019190250

### 1919F3/8

filtro regulador lubrificador



Entrada/saída de ar 3/8" GAS BSPT  
Capacidade pneumática máx. 1350 l/min  
Pressão máx. 9,5 bar  
Pressão de trabalho 0,5 - 8,5 bar  
Temperatura de trabalho 5 - 60 °C  
Capacidade do filtro 5 microns  
Capacidade recip. 60 cc ar / 90 cc óleo  
Peso 1,3 kg

1919F3/8 € 137,00 1 019190350

### 1919F1/2

filtro regulador lubrificador



Entrada/saída de ar 1/2" GAS BSPT  
Capacidade pneumática máx. 2500 l/min  
Pressão máx. 9,5 bar  
Pressão de trabalho 0,5 - 8,5 bar  
Temperatura de trabalho 5 - 60 °C  
Capacidade do filtro 5 microns  
Capacidade recip. 60 cc ar / 90 cc óleo  
Peso 1,3 kg

1919F1/2 € 137,00 1 019190450

### 1919RB-F

jogo de copos de substituição para artigos 1919F - 1/4", 3/8" e 1/2"



1919RB-F € 24,00 1 019190510

### 1919RF-F

elemento filtrante de substituição para artigos 1919F - 1/4", 3/8" e 1/2"



1919RF-F € 9,00 1 019190530

### 1919RM-F

manómetro de substituição para artigos 1919F - 1/4", 3/8" e 1/2"



1919RM-F € 14,00 1 019190520

### 1919ML

mini lubrificador de linha



Ø	L mm	Ø mm	€	1	019190030
1/4"	63	36	18,00	1	019190030
3/8"	63	36	19,50	1	019190032

### 1919SC

mini separador de condensados



Ø	L mm	Ø mm	€	1	019190035
1/4"	80	40	22,50	1	019190035

### 1919L

óleo de lubrificação ISO 32

Densidade a 20°C 875 Kg/m³  
Viscosidade 40°C 32 cSt  
Inflamabilidade COC 210°C



1919L € 16,00 5 019190050

# JOGOS DE FERRAMENTAS, MALAS, CAIXAS E CARROS



	MALAS					CAIXAS																
	2009N/BV	2029/VV	2032TV	2033P/VV	2036TV	C4	C5	C6T	C7	C9	C10	CP15L	CP17L	C10S	C12	C14	CP15	C18	C19	C19L	C20	C20L
5915VU/0						✓																
5915VU/1										✓	✓	✓	✓					✓				
5915VU/2									✓								✓				✓	✓
5915VU/3									✓	✓	✓	✓	✓						✓		✓	✓
5915VU/4																					✓	✓
5915VU/5															✓							
5915VU/AS														✓							✓	✓
5980MQ		✓																				
5980EL/A			✓	✓																		
5980EL/B		✓		✓	✓																	
5980ET/A			✓												✓							
5980ET/B		✓		✓	✓										✓							
5980U/BIKE												✓										✓
5980ID	✓																					
5914VU/M																✓						
5941KART										✓	✓						✓					



## 2001/B26

estojo de tecido com sortido de 26 ferramentas



2001/B26 € 200,00 1 020010050

- 55 6x7 - 8x9 - 10x11 - 12x13 - 14x15 - 16x17 mm
- 96N/SC9 1,5 - 2 - 2,5 - 3 - 4 - 5 - 6 - 8 - 10 mm
- 1044F 250 mm
- 1128BMX 145 mm
- 1150 180 mm
- 1201 3x75 - 4x100 - 5,5x150 mm
- 1202 PH1x80 - PH2x100 mm
- 1370 300 g
- 1692 2 m
- 1770A 9 mm

2001/BV € 43,50 1 020010051

## 2005PA/D

bolsa para ferramentas, vazia, em nylon, com cinto



2005PA/D € 56,00 1 020050000

## 2005PA/S

bolsa para ferramentas, vazia, em nylon, com cinto



2005PA/S € 27,50 1 020050020

## 2009N/BV

estojo de manutenção (vazio)



530x190x210 mm € 229,00 1 020090200

## 2009ID

mala com jogo de ferramentas para canalizadores



2009ID € 748,00 1 020090012  
(2009N/BV+5980ID)

## 2028/VV

Caixa de ferramenta, de polipropileno

2 painéis de ferramentas  
Fundo interior com divisórias removíveis  
Fechadura de combinação dupla



470x185x410 mm € 208,00 1 020280010

## 2028E

Mala com sortido de ferramentas de manutenção eletrónica e eletrotécnica



2028EL/A € 1.004,00 1 020280114  
(2028/VV+5980EL/A)  
2028ET/A € 1.008,00 1 020280118  
(2028/VV+5980ET/A)

## 2029/VV

mala para ferramentas, em polipropileno espesso, extremidades em alumínio  
2 painéis interiores para ferramentas



490x380x230 mm € 295,00 1 020290000

## 2029E

malas de ferramentas com jogos de ferramentas para electrónica e manutenção electrotécnica



2029BG-MQ € 1.795,00 1 020290257  
(2029/VV+5980MQ)  
2029 ET/B € 1.425,00 1 020290221  
(2029/VV+5980ET/B)  
2029 EL/B € 1.415,00 1 020290217  
(2029/VV+5980EL/B)

## 2029/RT

correia de ombro universal para malas e sacos



2029/RT € 19,10 1 020290900

## 2032/TV

carro para ferramentas, em plástico

2 painéis para ferramentas  
Bolso para ferramenta  
Fundo com componentes amovíveis



mm € 1 020320110  
430x370x200 382,00

## 2032/TE

carro com sortidos de ferramentas  
para trabalhos de manutenção electrónica e  
electrotécnica



€ 1 020320228  
2032TET/A 1.182,00  
(2032/TV+5980ET/A)  
€ 1 020320214  
2032T EL/A 1.179,00  
(2032/TV+5980EL/A)

## 2033 P/VV

mala de ferramentas em alumínio, com  
laterais em ABS

2 painéis para ferramentas  
Base interior com divisórias amovíveis



mm € 1 020330300  
500x380x200 428,00

## 2033P

malas de ferramentas com jogos  
de ferramentas para electrónica  
e manutenção electrotécnica



€ 1 020330127  
2033PET/B 1.555,00  
(2033P/VV+5980ET/B)  
€ 1 020330114  
2033PEL/A 1.225,00  
(2033P/VV+5980EL/A)  
€ 1 020330115  
2033PEL/B 1.550,00  
(2033P/VV+5980EL/B)

## 2036/TV

carro para ferramentas,  
em polipropileno espesso,  
extremidade em alumínio

2 painéis para ferramentas  
Pega telescópica  
Rodízios de esferas



mm € 1 020360000  
490x380x260 447,00

## 2036E

carro de ferramentas tipo trolley com jogos  
de ferramentas para electrónica  
e manutenção electrotécnica



€ 1 020360123  
2036TET/B 1.580,00  
(2036/TV+5980ET/B)  
€ 1 020360118  
2036EL/B 1.570,00  
(2036/TV+5980EL/B)

## 2037/TV

Mala tipo trolley, em polipropileno, com 4  
rodas, vazia

- Altamente resistente ao choque. Adequada para transporte em aviões.
- 2 painéis de ferramentas amovíveis.
- Porta-documentos incorporado.
- 4 rodízios amovíveis para manipulação horizontal do carro.
- 2 tabuleiros incluídos.
- 2 fechaduras aprovadas pela TSA com chaves.
- Pega revestida a borracha.



mm € 1 020370000  
420x325x275 mm 551,00

## 2038/TV

mala de ferramentas tipo trolley, em  
polipropileno espesso

- Elevada resistência a impactos
- Perfil vedante em alumínio
- 2 fechaduras aprovadas TSA com chaves
- 2 painéis de ferramentas amovíveis.
- Punho telescópico e rodas de grandes dimensões
- 2 punhos ergonómicos revestidos a borracha incluindo (1 punho lateral)
- Fundo espaçoso
- Bolsa porta-documentos
- 3 painéis de ferramentas interiores



mm € 1 020380000  
430x500x340 731,00



## 2041UC

Jogo de 33 ferramentas em caixa



2041UC € 306,00 1 020410200

- 55 6x7 - 8x9 - 10x11 - 12x13 - 14x15 - 16x17 mm
- 96/SC9 1,5 - 2 - 2,5 - 3 - 4 - 5 - 6 - 8 - 10 mm
- 111 200 mm
- 1048V 250 mm
- 1128BMX 145 mm
- 1150 180 mm
- 1201 2,5x50 - 3x75 - 4x100 - 5,5x100 - 6,5x150 mm
- 1202 PH0x60 - PH1x80 - PH2x100 mm
- 1370 300 g
- 1692 3m
- 1771 170 mm
- 1834/70 70 Lumen / 140 mm
- 1639NS-N 25m
- 1696 200 mm

535x282x87 mm - 4,5 Kg

## 2051N

jogo de 55 ferramentas para manutenção naval com caixa em propileno anti-choque



2051N € 737,00 1 020510200

- 42 7 - 8 - 10 - 12 - 13 - 14 - 17 - 19 mm
- 55AS 3/8x7/16 - 1/2x9/16 - 5/8x11/16"
- 96/SC9 1,5+10 mm
- 111 200 mm
- 920A 10 - 12 - 13 - 14 - 17 - 19 mm
- 920AS 7/16 - 1/2 - 9/16 - 11/16 - 7/8"
- 920/22 255 mm - 1/2 - 1/2
- 920/25 1/2 - 1/2
- 920/42 1/2
- 920/55 1/2
- 956C 1/2 - 16 - 20,8 mm
- 1048 250 mm
- 1084BM 160 mm
- 1128BMX 145 mm
- 1150BM 180 mm
- 1166BM 160 mm
- 1201 3x75 - 4x100 - 5,5x150 - 6,5x150 mm
- 1202 PH1x80 - PH2x100 mm
- 1390 35 mm
- 1490/2 240 mm
- 1737 145 mm
- 1778X
- 1995 WD40 400 ml
- 1639NS-N 25m

585x393x92 mm - 9 kg

## 2055HB

mala "Home Bag" com sortido de 24 ferramentas



2055HB € 181,00 1 020550210

- 55 6x7 - 8x9 - 10x11 - 12x13 mm
- 96N/SC9 1,5 - 2 - 2,5 - 3 - 4 - 5 - 6 - 8 - 10 mm
- 1128BMX 145 mm
- 1150 180 mm
- 1048V 250 mm
- 1201 3x75 - 4x100 - 5,5x100 mm
- 1202 PH0x60 - PH1x80 - PH2x100 mm
- 1370 300 g
- 1692 3m

373x275x70 mm - 3 Kg

## 2060/VV

mala para ferramentas, rígida

Flutuante, estanque/impermeável  
Em resina espessa  
Com válvula de pressão manual



IP67

490x410x210 mm € 404,00 1 020600101

## 2080/V6

estojo de ferramentas com 6 compartimentos amovíveis



2080/V6 385x320x60 mm € 33,00 1 020800060

## 2080/V6-U

estojo de ferramentas com 6 compartimentos amovíveis 2080/V6



2080/V6-U € 2,30 1 020800066

90x60x50 mm

## 2080/V12

estojo de ferramentas com 12 compartimentos amovíveis



2080/V12 300x145x330 mm € 50,50 1 020800000

## 2080/V12-...

estojo de ferramentas com 12 compartimentos amovíveis



2080/V12-S € 2,95 3 020800013

2080/V12-M € 4,50 2 020800015

2080/V12-L € 7,75 1 020800020

## C4 - 2104

estojo de ferramentas em tecido

Painel de ferramentas interno amovível  
Bolsas internas e externas e suporte elástico para ferramenta  
Base robusta impermeável com pés em borracha  
Fornecido com alça de transporte



C4	€ 94,00	1	021040000
2104VU/0	458,00	1	021040121
(C4+5915VU/0)			
≡ 360x330x260x mm - 2,5 kg			

## C5 - 2105

mochila para ferramentas, em tecido



C5	€ 131,00	1	021050000
2105VU0	495,00	1	021050121
(C5+5915VU/0)			
≡ 500x400x180 mm - 2,5 Kg			

## C6T - 2106

mochila para ferramentas, em tecido, com rodas



C6T	€ 188,00	1	021060010
2106T/VU0	552,00	1	021060121
(C6T+5915VU/0)			
≡ 480x370x220 mm - 4,5 kg			

## C7 - 2107

saco para ferramentas em tecido

2 painéis para ferramentas amovíveis  
Bolsa interior em PC  
2 bolsas exteriores  
Base interior em plástico, com divisórias amovíveis



C7	€ 197,00	1	021070000
2107VU/2	573,00	1	021070102
(C7+5915VU/2)			
2107VU/3	1.031,00	1	021070104
(C7+5915VU/3)			
≡ 440x370x170 mm - 3,5 kg			

## C8 - 2108

Mala de ferramentas tipo trolley em tecido high-tech

Punho telescópico  
2 painéis de ferramentas interiores amovíveis  
2 bolsos exteriores frontais  
Pode ser equipada com caixa de ferramentas ref. C10S



C8	€ 221,00	1	021080000
2108 VU/1	662,00	1	021080021
(C8+5915VU/1)			
≡ 470x370x280 mm - 4 kg			

## C9 - 2109

saco para ferramentas em tecido

- Base rígida
- Bolsos interiores e exteriores para ferramentas
- Bolso exterior com fecho ecler para maior segurança
- Bolso para objectos pessoais com cinta de segurança
- Fundo duplo
- Cordão duplo para níveis
- Alça de ombro para fácil transporte



C9	€ 105,00	1	021090000
2109 VU/1	547,00	1	021090021
(C9+5915VU/1)			
2109VU/3	939,00	1	021090124
(C9+5915VU/3)			
≡ 550x280x320 mm - 2,6 kg			

## C9/RT

correia de ombro para artigos C9 e C10



C9/RT	€ 13,10	1	021090900
-------	---------	---	-----------

# Beta

## C10 - 2110

saco para ferramentas em tecido

Estrutura rígida

Fundo duplo. Possibilidade de remoção para maior capacidade do saco.

Pega inclinável para fácil acesso ao conteúdo

Cintas elásticas para ferramentas e bolsos interiores e exteriores

Pala de cobertura

Tabuleiro para ferramentas incluído no fundo duplo



	€		
<b>C10</b>	132,00	1	021100000
<b>2110 VU/1</b> (C10+5915VU/1)	574,00	1	021100021
<b>2110VU/3</b> (C10+5915VU/3)	966,00	1	021100024
<b>2110VU/AS</b> (C10+5915VU/AS)	1.027,00	1	021100026

≡ 520x220x250 mm - 📦 3,3 kg

## C10S - 2110S

saco para ferramentas em tecido

Estrutura rígida

Fundo duplo. Possibilidade de remoção para maior capacidade do saco.

Pega inclinável para fácil acesso ao conteúdo

Cintas elásticas para ferramentas e bolsos interiores e exteriores

Pala de cobertura

Tabuleiro para ferramentas incluído no fundo duplo



	€		
<b>C10S</b>	104,00	1	021100001
<b>2110S VU/1</b> (C10S+5915VU/1)	545,00	1	021100101
<b>2110SVU/3</b> (C10S+5915VU/3)	938,00	1	021100104

≡ 420x220x250 mm - 📦 2,3 kg

# Beta

# Beta

## C11 - 2111

caixa de ferramentas, em tecido



	€		
<b>C11</b>	78,50	1	021110000
<b>2111 VU/1</b> (C11+5915VU/1)	520,00	1	021110101
<b>2111VU/3</b> (C11+5915VU/3)	913,00	1	021110104

≡ 400x240x220 mm - 📦 2 kg

## C12 - 2112

saco para ferramentas em tecido

Painel de ferramentas interior amovível

Elásticos para fixação das ferramentas e bolsos interiores e exteriores espaçosas

Abertura frontal para acesso mais fácil ao conteúdo

Base impermeável rígida com pés de borracha

Pode ser utilizado com o trolley C8



	€		
<b>C12</b>	171,00	1	021120000
<b>2112ET/A</b> (C12+5980ET/A)	971,00	1	021120128
<b>2112ET/B</b> (C12+5980ET/B)	1.300,00	1	021120129
<b>2112VU/5</b> (C12+5915VU/5)	1.205,00	1	021120156

≡ 500x370x270 mm - 📦 5 kg

## C13

mala de ferramentas com rodízios, feito de polipropileno sólido, vazia



	€		
<b>C13</b>	281,00	1	021130000

≡ 870x410x350 mm - 📦 7,2 kg

## C14

mala de ferramentas tipo trolley (fornecida vazia), em polipropileno, com 4 gavetas

• Estrutura em polipropileno de injeção para maior resistência ao impacto

• A tampa de proteção frontal acomoda 4 gavetas amovíveis (470x255):

1 gaveta 30 mm altura

2 gavetas 60 mm altura

1 gaveta 90 mm altura

• Fechadura centralizada frontal que permite trancar as tampas superior e frontal simultaneamente

• 2 pegas laterais

• 4 rodas traseiras resistentes

• Tabuleiro superior removível

• Painel de ferramentas embutido na tampa

• 3 tabuleiros

• Placa de identificação

• Fechadura TSA



	€		
<b>C14</b>	722,00	1	021140000
<b>2114VU/M</b> (C14+5914VU/M)	1.690,00	1	021140009

≡ 580x380x455 mm - 📦 10 kg

## CP15 - 2115

caixa de ferramentas, em plástico, com tabuleiros de ferramentas amovíveis

- 1 tabuleiro integrado na tampa
- 2 tabuleiros amovíveis com divisórias ajustáveis
- 1 tabuleiro interior com divisórias ajustáveis



	€		
CP15	40,50	1	021150201
2115PVU/1 (CP15+5915VU/1)	482,00	1	021150231
2115PVU/2 (CP15+5915VU/2)	417,00	1	021150233

≡ 445x240x250 mm - 📦 2 kg

## CP15L - 2115

caixa de ferramentas, série longa, em plástico, com tabuleiros de ferramentas amovíveis

- 3 tabuleiros integrados na tampa com divisórias ajustáveis
- 1 tabuleiro interior com divisórias ajustáveis



	€		
CP15L	54,00	1	021150202
2115PL-VU/1 (CP15L+5915VU/1)	496,00	1	021150241
2115PL-VU/3 (CP15L+5915VU/3)	888,00	1	021150244

≡ 558x277x270 mm - 📦 2,5 kg

# Beta

## 2115P L-MQ32

jogo 32 ferramentas isoladas para veículos híbridos, em estojo de plástico com tabuleiro em esponja suave



	€		
2115PL-MQ32	1.046,00	1	021150332

- 920MQ/55A
- 89MQ 10-12 mm
- 850MQ 1/4"
- 860TX/A10 T7-T8-T9-T10-T15-T20-T25-T27-T30-T40
- 920MQ/A 8-10-12-13-14-17-19 mm
- 920MQ/21 125mm
- 920MQ/22 250mm
- 1048MQ250 250mm
- 1150MQ 180mm
- 1164MQ160 160mm
- 1272MQ 4.5X80-6X100mm
- 1274MQ 3X100-4X100-5.5X125
- 1995MQ/G2 G2
- CP15L

## C16 - 2116

caixa de ferramentas, em plástico, com compartimentos interiores, vazia



	€		
C16	89,50	1	021160000
2116 VU/1 (C16+5915VU/1)	531,00	1	021160101
2116VU/3 (C16+5915VU/3)	924,00	1	021160104

≡ 500x260x260 mm - 📦 2,5 kg

## CP17 - CP17L - 2117

caixa de ferramentas, feita de aço inoxidável e plástico, bandeja de carga removível



CP17  
≡ 500x200x220 mm



CP17L  
≡ 575x245x265 mm

	€		
CP17	74,50	1	021170500
2117P-VU/1 (CP17+5915VU/1)	516,00	1	021170041
2117P-VU/3 (CP17+5915VU/3)	908,00	1	021170044
CP17L	107,00	1	021170502
2117L-VU/1 (CP17L+5915VU/1)	549,00	1	021170141
2117PL-VU/3 (CP17L+5915VU/3)	941,00	1	021170144

## C18 - 2118

caixa para ferramenta em chapa metálica



	€		
C18	35,50	1	021180001
2118 VU/1 (C18+5915VU/1)	478,00	1	021180031

≡ 450x200x100 mm - 📦 3 kg

# Beta

# Beta

## C19 - 2119 - C19L - 2119L

caixa extensível com três divisões em chapa metálica



C19

≡ 450x200x160 mm



C19L

≡ 550x200x160 mm

	€		
C19	46,50	1	021190001
C19L	60,00	1	021190002
2119VU/3 (C19+5915VU/3)	880,00	1	021190024
2119L-VU/3 (C19L+5915VU/3)	894,00	1	021190124

## C20 - C20L - 2120

caixa extensível com cinco divisões em chapa metálica



C20

≡ 450x200x210 mm



C20L

≡ 550x200x210 mm

	€		
C20	66,00	1	021200001
2120 VU/2 (C20+5915VU/2)	442,00	1	021200016
2120VU/3 (C20+5915VU/3)	900,00	1	021200028
2120 VU/4 (C20+5915VU/4)	1.121,00	1	021200018
2120VU/AS (C20+5915VU/AS)	961,00	1	021200021
C20L	71,50	1	021200002
2120L-VU/2 (C20L+5915VU/2)	447,00	1	021200116
2120L-VU/3 (C20L+5915VU/3)	905,00	1	021200128
2120L-VU/4 (C20L+5915VU/4)	1.126,00	1	021200118
2120L-VU/AS (C20L+5915VU/AS)	966,00	1	021200121

## C20TSS

Caixa de ferramentas extensível com 5 divisões, em aço inox AISI 304



	€		
C20TSS	257,00	1	021203001

≡ 450x200x210 mm - 4kg

## C22B

caixa de ferramentas metálica



C22B O

≡ 720x320x310 mm



C22BM O

≡ 850x360x350 mm



C22BL O

≡ 1010x410x400 mm

	€		
C22B-O	186,00	1	022000150
C22BM-O	214,00	1	022000160
C22BL-O	287,00	1	022000170

C22B O: 13 kg  
C22BM O: 20 kg  
C22BL O: 26 kg

## C22W

caixa para ferramenta vazia, em chapa metálica, forrada, para uma maior protecção da ferramenta



C22W O

≡ 690x300x360 mm



C22WL O

≡ 990x300x360 mm

	€		
C22W-O	208,00	1	022000269
C22WL-O	270,00	1	022000299

C22W O: 15 kg  
C22WL O: 28 kg

## C22P

baú para ferramentas para a construção civil, em chapa metálica

pegas retrácteis integradas, sapatas elevadas para mobilização com porta-paletes, fechadura dupla anti-roubo (não incluída)



C22PM O

≡ 915x540x430 mm



C22PL O

≡ 1220x720x615 mm

	€		
C22PM-O	551,00	1	022000240
C22PL-O	854,00	1	022000245

C22PM O: 39 kg  
C22PL O: 67 kg

## CARROS

### FERRAMENTAS SORTIDAS

### MÓDULOS

	C22S					C24S/6			C24S/7		C24S/8
	C22S	C23S	C23SC	C23ST	C24S/5	C24S/6	C24S/7	C24S/8	C39/6	C39MD	C39/8
<b>5902MT</b>	✓	✓	✓								
<b>5902MT/AS</b>											
<b>5902VI</b>	✓	✓		✓							
<b>5904VG/3</b>										✓	✓
<b>5905VG/1</b>											
<b>5905VG/2</b>											
<b>5910VI/3</b>											
<b>5953VI</b>											
<b>5953VG</b>											
<b>5954VI</b>											
<b>5954VG</b>											
<b>5940SBK</b>											
<b>5941 VU-M</b>											
<b>5957U-P</b>											
<b>5957VG</b>											
<b>5957VI</b>											
<b>5958U</b>											
<b>5904VU/1M</b>				✓	✓	✓	✓	✓	✓	✓	✓
<b>5904VG/1M</b>											
<b>5904VU/2M</b>											
<b>5904VG/2M</b>						✓	✓	✓	✓	✓	✓
<b>5927VU/M</b>											
<b>5935VG/1MB</b>											
<b>5935VI/1MB</b>											
<b>5935VI/2MB</b>											
<b>5935ET/1MB</b>											
<b>5935VU/1MB</b>											
<b>5988ROAD/7M</b>											✓
<b>5988U6/M</b>											✓
<b>5904VI/1T</b>				✓	✓	✓	✓	✓	✓	✓	✓
<b>5904VG/5T</b>											
<b>5904VI/2T</b>										✓	✓
<b>5904VI/3T</b>										✓	✓
<b>5904VG/2T</b>				✓	✓	✓	✓	✓	✓	✓	✓
<b>5904VU/3T</b>											
<b>5904VU/2T</b>						✓	✓	✓	✓	✓	✓
<b>5904VG/3T</b>											
<b>5908VG/2T</b>											
<b>5908VI/2T</b>											
<b>5910VI/3T</b>											
<b>5910VG/3T</b>											
<b>5938U/2T</b>											





## C22S

baú portátil para ferramenta  
com três gavetas

Principais características:

- 3 gavetas (588x257 mm)
- com guias de rolamento de esferas:
- 1 gaveta, 50 mm altura.
- 2 gavetas, 70 mm altura.
- Fecho centralizado frontal de segurança .
- Pegas laterais retrácteis para uma maior facilidade de manuseamento.

19 kg



C22S-O



C22S-G



C22S-R

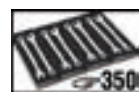

h	max
50 mm	25 kg
70 mm	25 kg

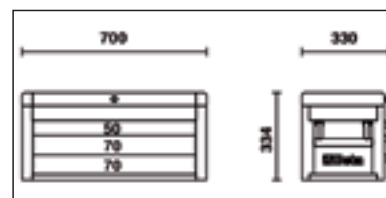
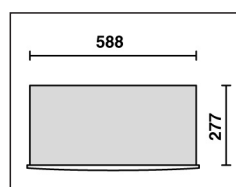

	€		
C22S-O	375,00	1	022000501
C22S-G	375,00	1	022000502
C22S-R	375,00	1	022000503

## C23S

baú portátil para ferramenta  
com cinco gavetas

Características principais:

- 5 gavetas (588x257 mm)
- em guias de rolamentos de esferas:
- 2 gavetas 50 mm altura.
- 3 gavetas, 70 mm altura.
- Fecho centralizado frontal de segurança.
- Pegas laterais retrácteis para uma maior facilidade de manuseamento.

26 kg



C23S-O



C23S-G



C23S-R



h	max
50 mm	25 kg
70 mm	25 kg

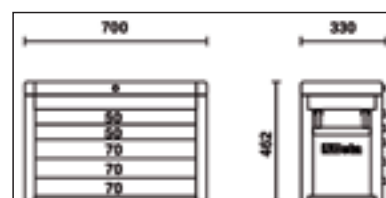
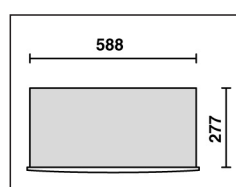

	€		
C23S-O	469,00	1	023000501
C23S-G	469,00	1	023000502
C23S-R	469,00	1	023000503

## C23SC - 2300SC

baú portátil para ferramenta  
com oito gavetas

Características principais:

- 8 gavetas em guias de rolamentos de esferas:
- 4 gavetas, 50 mm altura
- 3 gavetas, 70 mm altura
- 1 gaveta, 100 mm altura.
- Fecho centralizado frontal de segurança.
- Pegas laterais retrácteis para uma maior facilidade de manuseamento.

28 kg



C23SC-O



C23SC-G



C23SC-R

h	max
50 mm	25 kg
70 mm	25 kg

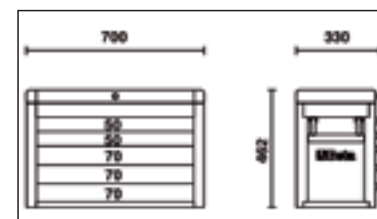
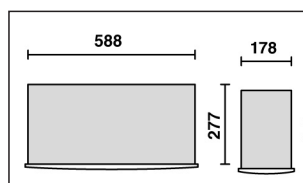

	€	1	023000511
C23SC-O	529,00	1	023000511
C23SC-G	529,00	1	023000512
C23SC-R	529,00	1	023000513

## C23ST

baú portátil para ferramenta  
com cinco gavetas

Características principais:

- 5 gavetas (588x367 mm) em guias de rolamentos de esferas:
- 5 gavetas, 70 mm altura.
- Fecho centralizado frontal de segurança.
- Pode ser equipado com o kit de 4 rodízios e 1 pega (2300ST/KIT)

36 kg



C23ST-O



C23ST-G



C23ST-R

h	max
70 mm	25 kg

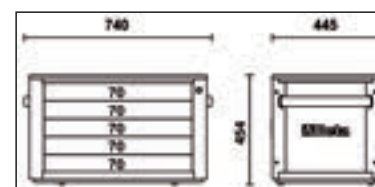
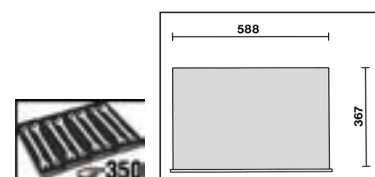

	€	1	023000521
C23ST-O	578,00	1	023000521
C23ST-G	578,00	1	023000522
C23ST-R	578,00	1	023000523

## 2300ST/KIT

kit de 4 rodízios e 1 pega para item C23ST

- 4 rodízios Ø 125 mm:  
2 fixos e 2 direccionáveis (2 com travão).
- Pega telescópica

6,5 kg

2300ST/KIT € 167,00 1 023000950



## CD23S

Trolley Caddy

Características principais:

- Plano de trabalho superior em ABS compatível com os modelos C22S, C23S, C23SC.
- A pega amovível pode ser guardada debaixo do chassis.
- 4 rodízios de Ø 125 mm:  
2 fixos e 2 direccionáveis (um com travão).
- Carga máxima: 250 kg.

14 kg

CD23S € 214,00 1 023000610



## C04TSS-7

carro com sete gavetas, totalmente em aço inoxidável

Principais características:

- Sete gavetas (570 x 410 mm) com calhas assentes em rolamentos de esferas;
- 6 gavetas, 83 mm altura;
- 1 gaveta, 170 mm altura;
- 4 rodízios Ø 125 mm
- 2 fixos e 2 giratórios (dois com travão);
- Fechadura frontal centralizada;
- Estrutura totalmente fabricada em aço inoxidável
- Roletes, suportes, esferas, interiores de gavetas e calhas em aço inoxidável
- Pegas das gavetas em alumínio

63 kg

C04TSS/7 € 2.275,00 1 024003077 243



700 kg

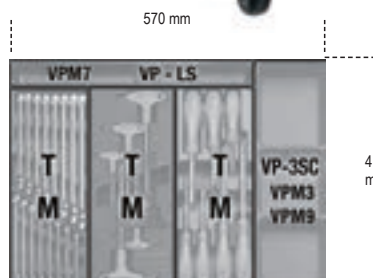

h	max
83 mm	25 kg
170 mm	30 kg

## C24S/5

carro com 5 gavetas

Características principais:

- 5 gavetas (588x367 mm) com guias de rolamentos de esferas:
- 2 gavetas, 70 mm altura
- 2 gavetas, 140 mm altura
- 1 gaveta, 280 mm altura
- Base das gavetas protegida por tapetes de espuma de borracha.
- 4 rodízios de Ø 125 mm:
- 2 fixos e 2 direccionáveis (um com travão).
- Fecho centralizado frontal de segurança.
- Capacidade de carga estática: 800 kg.
- Plano de trabalho termoplástico compatível com os modelos C22S, C23S, C23SC e C23ST
- Porta-garrafas lateral integrado.
- Possibilidade de aplicação do porta-rolos modelo 2400S-R/PC.

800 kg



C24S/5-O

52 kg



C24S/5-G



C24S/5-R

h	max
70 mm	25 kg
140 mm	30 kg
280 mm	35 kg

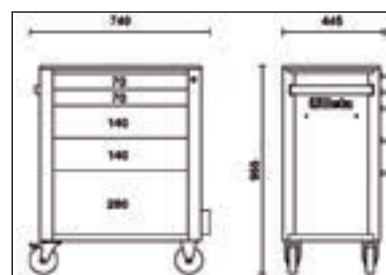
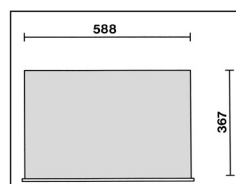
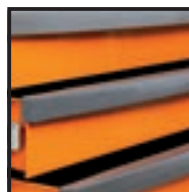

	€	1	024002051
C24S/5-O	704,00	1	024002051
C24S/5-G	704,00	1	024002052
C24S/5-R	704,00	1	024002053

## C24S/6

carro com 6 gavetas

Características principais:

- 6 gavetas (588x367 mm) com guias de rolamentos de esferas:
- 4 gavetas, 70 mm altura
- 1 gaveta, 140 mm altura
- 1 gaveta, 280 mm altura
- Base das gavetas protegida por tapetes de espuma de borracha.
- 4 rodízios de Ø 125 mm:
- 2 fixos e 2 direccionáveis (um com travão).
- Fecho centralizado frontal de segurança.
- Capacidade de carga estática: 800 kg.
- Plano de trabalho termoplástico compatível com os modelos C22S, C23S, C23SC e C23ST
- Porta-garrafas lateral integrado.
- Possibilidade de aplicação do porta-rolos modelo 2400S-R/PC.

  
800  
kg



 55 kg



C24S/6-O





C24S/6-G



C24S/6-R

h	↓ m <sub>ax</sub>
70 mm	25 kg
140 mm	30 kg
280 mm	35 kg



	€		
C24S/6-O	780,00	1	024002061
C24S/6-G	780,00	1	024002062
C24S/6-R	780,00	1	024002063

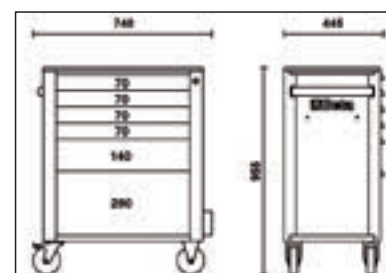
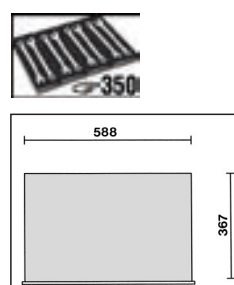

## C24S/7

carro com 7 gavetas

Características principais:

- 7 gavetas (588x367 mm) com guias de rolamentos de esferas:
- 5 gavetas, 70 mm altura
- 1 gaveta, 140 mm altura
- 1 gaveta, 210 mm altura
- Base das gavetas protegida por tapetes de espuma de borracha.
- 4 rodízios de Ø 125 mm:
- 2 fixos e 2 direccionáveis (um com travão).
- Fecho centralizado frontal de segurança.
- Capacidade de carga estática: 800 kg.
- Plano de trabalho termoplástico compatível com os modelos C22S, C23S, C23SC e C23ST
- Porta-garrafas lateral integrado.
- Possibilidade de aplicação do porta-rolos modelo 2400S-R/PC.

800 kg



C24S/7-O

58 kg



C24S/7-G



C24S/7-R

h	max
70 mm	25 kg
140 mm	30 kg
210 mm	30 kg

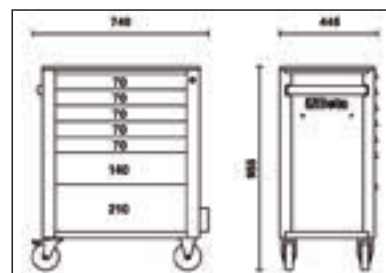
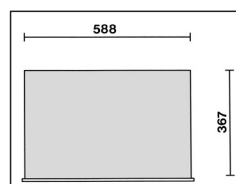

	€	1	024002071
C24S/7-O	845,00	1	024002071
C24S/7-G	845,00	1	024002072
C24S/7-R	845,00	1	024002073

## C24S/8

carro com 8 gavetas

Características principais:

- 8 gavetas (588x367 mm) com guias de rolamentos de esferas:
- 6 gavetas, 70 mm altura
- 2 gavetas, 140 mm altura
- Base das gavetas protegida por tapetes de espuma de borracha.
- 4 rodízios de Ø 125 mm:
- 2 fixos e 2 direccionáveis (um com travão).
- Fecho centralizado frontal de segurança.
- Capacidade de carga estática: 800 kg.
- Plano de trabalho termoplástico compatível com os modelos C22S, C23S, C23SC e C23ST
- Porta-garrafas lateral integrado.
- Possibilidade de aplicação do porta-rolos modelo 2400S-R/PC.

61 kg

800 kg



C24S/8-O



C24S/8-G



C24S/8-R

h	max
70 mm	25 kg
140 mm	30 kg

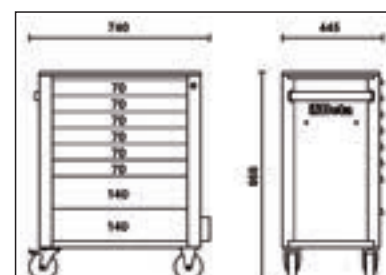
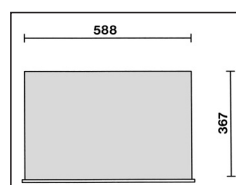

	€	1	024002081
C24S/8-O	911,00	1	024002081
C24S/8-G	911,00	1	024002082
C24S/8-R	911,00	1	024002083



## C24SA/6

carro com seis gavetas,  
com sistema anti-inclinação

Principais características:

- Seis gavetas (588x367 mm), com calhas assentes em rolamentos de esferas:
- 4 gavetas 70 mm altura
- 1 gaveta 140 mm altura
- 1 gaveta 280 mm altura
- Gavetas protegidas por tapetes em borracha
- Quatro rodízios Ø 125 mm:
- 2 fixos e 2 rotativos (um com travão).
- Fecho de segurança frontal centralizado
- Capacidade de carga (estático): 800 kg.
- Superfície de trabalho em termoplástico adaptável aos tabuleiros de ferramentas C22S, C23S, C23SC e C23ST.
- Suporte lateral para garrafa
- Possibilidade de inclusão de suporte para papel em rolo 2400S-R/PC.

55 kg

800  
kg



C24SA/6-O



C24SA/6-G



C24SA/6-R

h	max
70 mm	25 kg
140 mm	30 kg
280 mm	35 kg

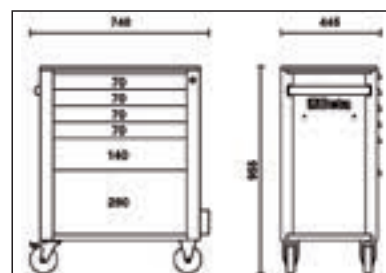
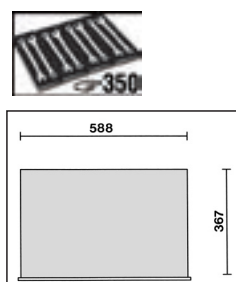

	€	1	024002161
C24SA/6-O	829,00	1	024002161
C24SA/6-G	829,00	1	024002162
C24SA/6-R	829,00	1	024002163

## C24SA/7

carro com 7 gavetas,  
com sistema anti-inclinação

Características principais:

- Sete gavetas (588x367 mm) com guias de rolamentos de esfera:
- 5 gavetas, 70 mm altura
- 1 gaveta, 140 mm altura
- 1 gaveta, 210 mm altura
- Base das gavetas protegida por tapetes de espuma de borracha.
- Não permite a abertura simultânea de mais do que uma gaveta
- Quatro rodízios de 125 Ø mm:
- 2 fixos e 2 rotativos (um com travão)
- Fecho centralizado frontal de segurança
- Capacidade de carga estática: 800 kg
- Porta-garrafas lateral integrado

800  
kg



C24SA/7-O



C24SA/7-G



C24SA/7-R

58 kg

h	max
70 mm	25 kg
140 mm	30 kg
210 mm	30 kg

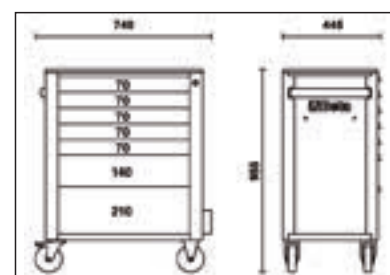
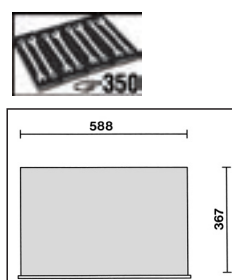

	€	1	024002171
C24SA/7-O	883,00	1	024002171
C24SA/7-G	883,00	1	024002172
C24SA/7-R	883,00	1	024002173